

# HOW

TO  
LOAD  
OPERATE  
DISASSEMBLE  
ASSEMBLE

AMERICAN · GERMAN  
ITALIAN · JAPANESE  
RUSSIAN AND OTHER

# MILITARY SMALL ARMS

A BASIC MANUAL  
OF  
MILITARY SMALL ARMS

**SIMPLE  
COMPLETE  
AUTHORITATIVE**

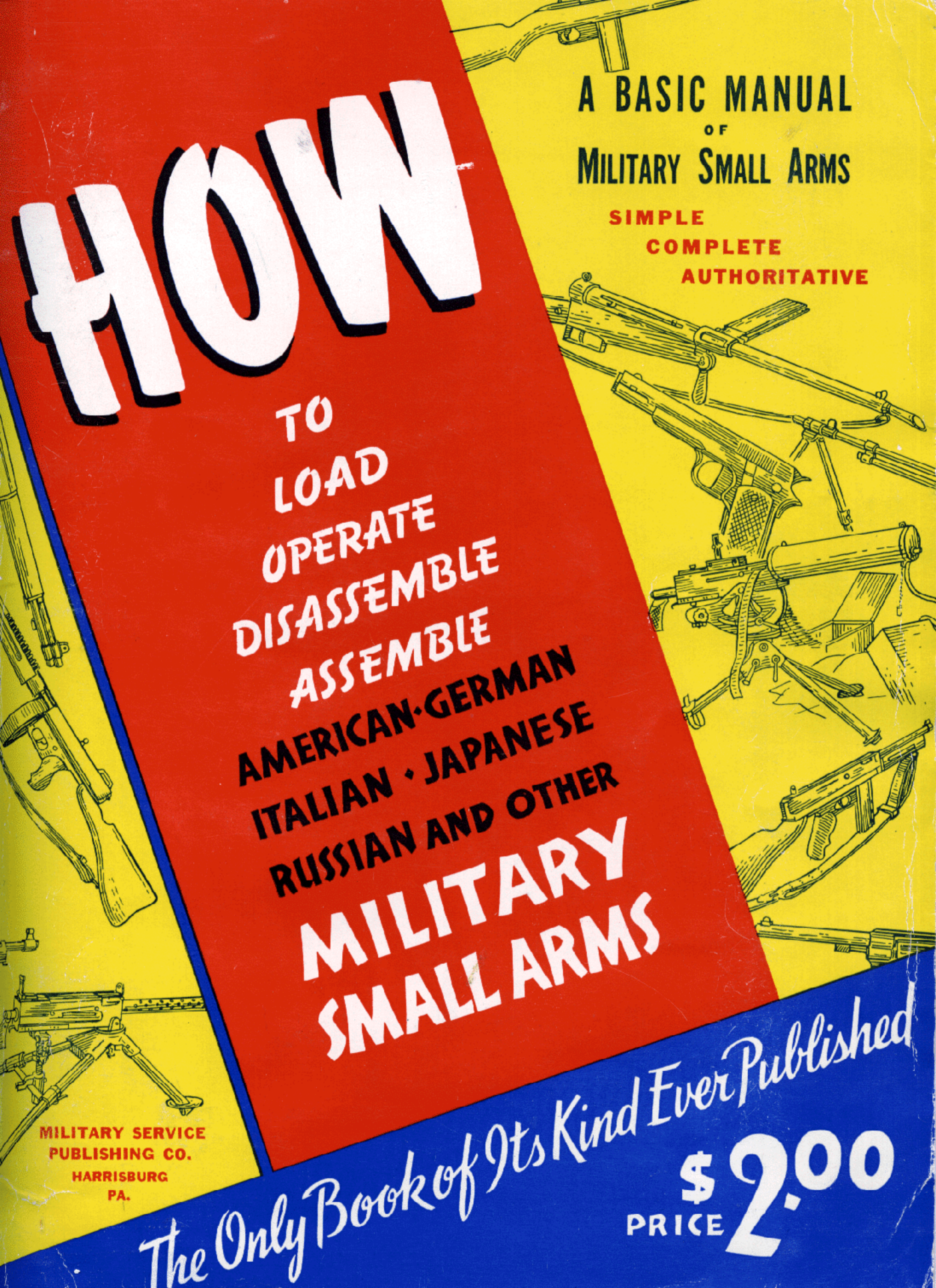

MILITARY SERVICE  
PUBLISHING CO.  
HARRISBURG  
PA.

*The Only Book of Its Kind Ever Published*

PRICE \$ **2.00**



**BASIC MANUAL**  
**OF**  
**MILITARY SMALL ARMS**

*American--British--Russian*  
*German--Italian--Japanese*  
*and all other important nations*

**By**

**W. H. B. Smith**

**Working Drawings by George R. Gans**  
**Photography by Albert Losch, William Stack, Ray Snow,**  
**H. B. Flaum, Jack Bernstock**

**MILITARY SERVICE PUBLISHING COMPANY**  
**Harrisburg, Pennsylvania**



Copyright, 1943

W. H. B. Smith



Printed in the United States of America

by

The Telegraph Press  
Harrisburg, Pennsylvania



# TABLE OF CONTENTS

## Austria

Austrian Steyr 9-mm Pistol .....	2
Austrian Steyr-Mannlicher Rifle and Carbine .....	4
Austrian Schwarzlose 8-mm Machine Gun .....	6

## Belgium

Belgian Browning Long 9-mm Automatic Pistol ..	9
--	---

## Great Britain

British Enfield .380 Pistol No. 2 .....	11
British Webley .455 Mark VI Pistol No. 1 .....	12
British Smith and Wesson .38 Pistol No. 2 .....	14
British Webley .455 Automatic .....	16
British Army Rifles .....	18
British Bren .303 Light Machine Gun .....	22
British Lewis .30-06 and .303 Light Machine Gun	28
British Besa Machine Guns .....	34
British Vickers .303 Machine Gun .....	38
British Hotchkiss .303 Light Machine Gun .....	44
British Sten 9-mm Machine Carbine Mark I, II, and III .....	48
British Service Colt .455 Automatic Pistol .....	51
British (Australian) Austen 9-mm Machine Carbine	52

## Denmark

Danish Madsen 8-mm Light Machine Gun .....	55
--	----

## Finland

Finnish Suomi 9-mm Submachine Gun .....	58
---	----

## France

French Modele D'Ordonnance 1892 Revolver .....	59
French Ruby 7.65-mm Automatic .....	60
French Star 7.65-mm Automatic .....	60
French 1935-A 7.65 Long Automatic .....	61
French Army Rifles .....	62
French Chauchat Machine Rifle .....	63
French 1914 Hotchkiss 8-mm Machine Gun .....	64
French Chatellerault 7.5-mm 1924 Machine Gun ..	66

## Germany

German Luger (Parabellum) 9-mm 08 Automatic ..	68
German Mauser 7.65-mm (32 C A P) Pistol .....	73
German Mauser 7.63-mm Automatic Pistol .....	74
German Walther 9-mm 38 Automatic .....	78
German 9-mm 40 Machine Pistol .....	81
German Steyr-Solothurn 9-mm Machine Pistol ...	82
German Mauser 7.63-mm 1932 Machine Pistol ...	84
German Erma 9-mm Machine Pistol .....	85
German 9-mm 38 Machine Pistol .....	86
German Neuhausen 9-mm Machine Pistol .....	89
German Bergmann 9-mm 1934 Machine Pistol ...	90
German 7.92-mm 41 and 41-W Rifle .....	92
German 7.92-mm Gewehr 42 Automatic Rifle ...	94
German Mauser Rifle Model 98 7.92-mm .....	95
German 7.92-mm 42 Light Machine Gun .....	96
German 7.92-mm 34 Light Machine Gun .....	98
German Maxim Light Machine Gun 08-15 .....	103
German Maxim 7.92-mm 08 Machine Gun .....	106

## Hungary

Hungarian Frommer Automatic Pistol 7.65-mm ...	108
--	-----

## Italy

Italian Beretta 9-mm Submachine Gun .....	109
Italian Beretta 9-mm 1934 Automatic .....	110
Italian Glisenti 9-mm 1910 Automatic .....	112
Italian Revelli (Fiat 1914) 6.5-mm Machine Gun ..	114
Italian Mannlicher-Carcano Rifle .....	117
Italian Breda 6.55-mm and 7.35-mm 30 Machine Gun .....	118
Italian Fiat 8-mm 35 Machine Gun .....	120
Notes on Italian Weapons .....	121

## Japan

Japanese Nambu 8-mm Automatic .....	123
Japanese Arisaka 6.5-mm Rifle .....	126
Japanese Nambu 6.5-mm 1922 Machine Rifle ...	128
Japanese 6.5-mm and 7.7-mm 96 Light Machine Gun .....	132
Japanese Hotchkiss Heavy Machine Gun .....	130

## Mexico

Mexican Mendoza Light Machine Gun .....	133
---	-----

## Soviet Union

Russian Moisin Rifle .....	134
Russian Maxim 7.65-mm Machine Gun .....	135
Russian Degtyarov 7.62 1938 Light Machine Gun	136
Notes on Russian Small Arms .....	138

## Spain

Spanish Astra 9-mm Long 400 Automatic .....	141
---	-----

## United States

U. S. .45 1911 and 1911A1 Automatic .....	142
U. S. Smith and Wesson .45 1917 Revolver .....	148
U. S. Colt .45 1917 Revolver .....	150
U. S. Springfield .30-06 1903 Rifle .....	151
U. S. Rifle .30 M1 .....	154
U. S. Enfield .30 1917 Rifle .....	161
U. S. Carbine Cal. .30 M1 .....	187
U. S. Reising .45 50 and 55 Submachine Gun ..	164
U. S. .45 M3 Submachine Gun .....	178
U. S. Thompson .45 1928 Submachine Gun ...	170
U. S. Browning .30 1918 and 1918A1 Automatic Rifle .....	180
U. S. Browning 1918A2 Machine Rifle .....	186
U. S. Browning .30 1917 and 1917A1 Machine Gun .....	190
U. S. Johnson Light Machine Gun .....	198
U. S. Browning .50 M2 Machine Gun .....	200
U. S. Rocket Launcher A T M1 .....	207
Notes on Operating Principles and Holsters ...	209



# FOREWORD

This book is a military classic. It is of real value to every man who uses military arms.

The coverage of the basic United States weapons will help any service man achieve a quick and comprehensive understanding of his weapons. The sections on foreign arms will also help to develop a "weapons sense" in the reader; prepare him to grasp opportunities on the field of battle; and serve to increase his confidence in the superlative arms with which he is equipped.

This is primarily a book for the person who is not an expert. The text is so simply presented that even a person without any knowledge of firearms can follow it with ease. The photographs were specially prepared from the actual weapons themselves to teach step-by-step all the essentials. The original working drawings are simple and clear, and are presented for the benefit of the layman, not the draftsman.

However, it is also a book for the expert—the soldier,

collector, manufacturer and designer, all will find much of interest and value in it. You can study a hundred handbooks and manuals to find the data packed into this work.

There are no military secrets in this book: everything in it is known to our enemies, who have captured and are using specimens of all our arms. But there is a tremendous wealth of valuable military information in it for every American who cares to arm himself with a knowledge of a subject on which our national security rests, and on which it will rest for a long time after the present war ends.

The author is perhaps the one person in the United States with the necessary combined knowledge of firearms, writing and editing to bring this remarkable book into being. It is a most important addition to the long line of worthy and authoritative military books published by the outstanding publishers in that field.

G. B. JARRETT,

LT. COL. O. D., ARMY OF U. S.

CHIEF, FOREIGN MATÉRIEL SECTION,

ABERDEEN PROVING GROUNDS.



## Author's Note

It is a sobering thought that of all the peoples in the world today, we in the United States know less about arms than any other great power.

Our weapons are no secret to the Germans or the Japs. In the year 1936, the year our superb M1 or Garand Rifle was adopted, a commercial publishing house in Leipzig, Germany, published a book on Automatic Weapons by P. Curti replete with photographs and data on the Garand; as well as on our Thompson, Lewis and Browning Guns. Marcel Devouges, a French arms authority, covered the same weapons in his language in a book which had a large international sale.

Since that time quantities of every weapon we possess have fallen into the hands of the Germans and the Japanese—just as quantities of their arms have been captured by us and our allies. In many instances they have issued handbooks on the use of those weapons to their troops.

Millions of copies of fine handbooks on individual weapons used by us and our allies have been commercially published and sold in England and throughout the British Empire.

By simple treatment followed throughout, by the widest possible use of pictures and specially prepared elementary drawings, this book seeks to give the American soldier a general insight into all weapons he is likely to encounter here or abroad.

In dealing with United States weapons, the standard field manuals have been closely adhered to, though the material has been presented in a standardized style which tends to simplify the text and give coherence to the overall picture of arms in general. The terms used are those of the U. S. services throughout; but the popular names of the various weapons have also been included. It will be noted that in U. S. procedure arms adopted in most cases carry the year of adoption preceded by the letter M (for model) after the name of the arm; and that when improvements are made in the original models, such improved models are indicated by the letter A and a number 1, 2, 3, etc., following the date. Thus the first bolt-action "Springfield" was called the U. S. Rifle, Caliber .30 M 1903. A modification was called the M1903 A-1. A recent modification permitting easier manufacture is called the M1903-A3; while the very latest modification, developed for snipers, is called the M1903 A-4.

In the same manner the Automatic Pistol, cal. .45 M1911 and M1911 A1 differ only in minor improvements. And so on down the line of Browning Automatic Rifle M1918 and M1918 A1, etc.

In general the German Army practice follows that of the U. S., the rifle, pistol, light machine gun, etc., being called by the weapon name followed by date of adoption—thus the standard pistol is the "Pistole '08," which we call the "Luger." However, the German practice of throwing modified weapons into service for field test, rather than doing exhaustive ordnance testing first as in our case, results in a larger number of issued modifications than is customary with us. Six models of the German Light Machine Gun '34 are known, for example, all being designated by different letters.

British practice is to give a number to each weapon, then follow that with a "Mark I, II or III," for the

modifications, minor changes often being designated however as "Mark I\*" rather than as Mark II. Thus their original bolt-action "Enfield" was called the Rifle No. 1, Mark I. The most recent edition of this is the Rifle No. 1, Mark III\*. While all their rifles use the same cartridges, the Rifles No. 1, 2 and 3 are radically different in design. Like the U. S.,\* Great Britain uses the manufacturer's or inventor's name followed by a special designation when the arm is developed outside a government arsenal: thus .303" Hotchkiss Machine Gun, Mark I.

French and Italian procedure also has been to use year of adoption as identification; but the variety of weapons used by them reached the point where arms often had to be classed by arsenal of manufacture or popular name. This confusion of design, attributable to politically controlled Ordnance Departments, had much to do with the rapid collapse of both those powers.

Japanese procedure in general is to identify weapon by class name followed by year of adoption, but using as the year that of the Meiji reign. Thus the Jap Arisaka rifle in caliber 6.5mm (256") adopted in 1905 is called the Year (or Pattern) 38: 1905 being the 38th year of the ruling Meiji era. Like the Italians and the French, the Japanese have adopted a very wide range of types and calibers in small arms; an error too late to rectify, and which will be a big factor in their eventual downfall.

The Russians, like the British, while using captured enemy matériel as well as lend-lease arms on a large scale have developed a few original designs in small arms, all the author has seen being masterpieces of simplicity and efficiency. Like the Germans, the Russians put new and refined designs through earliest possible battle test; and as a result have to use a somewhat complex system of identification for various models. In standardized equipment the arm will be identified by type name preceded by one or more letters and the year of manufacture. As in the United States, the pieces which particularly appeal to the soldiers are more commonly known by the names of the inventors: thus the "Deg" or Degtyarov Light Machine Gun, and the Simonov Auto Rifle.

Wherever possible names of parts having like functions are given the same name throughout this book, though on U. S. arms the Service nomenclature has been closely followed to prevent confusion when this book is used in conjunction with Government handbooks. Names of parts in British weapons have occasionally been changed to their American equivalents when such changes simplify explanations. In translating from the French, German and Italian I have endeavored to steer a middle course between literal translations and our own nomenclature. Since practically all the Japanese weapons are merely modifications of French, British and American second-class arms, the terms used are those in familiar U. S. practice.

All photographs have been deliberately posed not only to show graphically how to handle and care for the weapon, but also to show the parts from so many angles that they may be readily identified during dismounting and reassembling.



# Sources of Material

- U. S. Rifle M1 (Garand)**  
and  
**U. S. Carbine M1 (Winchester)** Winchester Repeating Arms Co., manufacturers of the Garand and inventors and manufacturers of the Carbine, through the courtesy of the U. S. Ordnance Department.  
Original photography by Winchester Plant Photographer William Stack. Technical assistance from Lawrence Dickovich, Emil Scherer and Jack Lacy of Winchester.
- U. S. Rifle M1903 (Springfield)**  
and  
**U. S. Rifle M1917 (Enfield)** A. P. Wonhart, National Rifle Assn. and U. S. Govt. handbooks. Special drawings courtesy of McGraw Hill Pub. Co.
- Auto Pistol M1911 (Colt)**  
and  
**U. S. Army Revolver (Colt)** Colt's Patent Firearms Mfg. Co.
- U. S. Army Revolver .45 (S&W)**  
and  
**U. S. Navy Revolver .38 (S&W)** Smith and Wesson Arms Co. and Mr. David H. Murray.
- H & R-Reising Submachine Gun** Harrington and Richardson-Reising Arms Co., manufacturers, and Mr. Wm. B. Remington.
- Thompson Submachine Gun** The Pennsylvania State Guard. Original photography by Ray Snow. Govt. Handbooks.
- U. S. Submachine Gun M3** U. S. Ordnance Dept., American Rifleman, Army Ordnance and London Illustrated News.
- Browning Automatic Rifle** A. P. Wonhart, F. N. of Belgium, U. S. and British Handbooks; Marlin Arms Co., manufacturers.
- Johnson Light Machine Gun** American Armaments and A. J. Miranda, distributors.
- Lewis Light Machine Gun** Savage Arms Co., original manufacturers; U. S. and British handbooks.
- Browning Machine Gun, M1917 (.30 cal.)** Infantry Journal, U. S. and foreign handbooks. U. S. Marine Corps.
- Browning Machine Gun, M2 (.50 cal.)** General Motors Corp, Frigidaire Division, manufacturers of the .50 cal. Browning, courtesy of War Dept., Bureau of Public Relations.
- A. T. Rocket Launcher (Bazooka)** U. S. Ordnance Dept., Signal Corps, American Rifleman, European News Service and foreign publications.

## Sources on Foreign Weapons

The governments, groups and organizations, and individuals already accredited, whose individual contributions are too many to itemize.

While all data in this book was originally developed from a study of the actual weapons themselves, all information has been checked against foreign handbooks on these weapons.

The French publishing firm of Charles-Lavanzelle & Cie; and the German Verlag Offene Worté, Verlag R. Eifenschmidt and Verlag von Huber & Co., have continued publication of detailed studies of their own and foreign arms throughout the course of the war. Like the similar firms of Gale & Polden and W. H. Smith in England, these are old line publishing firms whose books are developed for textbook use.



## Author's Acknowledgments

Appreciation is expressed for active cooperation on various phases of this work to the following:

The U. S. War Department and its Ordnance Department, Signal Corps and Bureau of Public Relations. The U. S. Navy Department and Marine Corps. His Majesty's War Office and the British Information Service. The Canadian and Australian Governments and their respective Information Services. The Brazilian, Chinese, Czech, Mexican and Royal Netherlands Governments.

To The National Rifle Association, the U. S. Infantry Association and the U. S. Ordnance Association, together with their respective magazines, The American Rifleman, the Infantry Journal and Army Ordnance.

To the Winchester Repeating Arms Co., Colt's Patent Firearms Mfg. Co., Smith and Wesson Arms. Marlin Arms Co., Harrington and Richardson-

Reising Arms Co., Savage Arms Co., American Armaments Corp., General Motors Corp. (manufacturers of Browning Machine Guns) and Western Cartridge Co., and Mr. W. H. Depperman.

To The Jarrett Museum of World War History, the Yust Military Reference Library, the Arthur P. Wonhart Collection, Francis Bannerman and Sons and the Smithsonian Institute.

To George R. Gans for original working drawings; and to Albert Losch, Jack Bernstock, H. B. Flaum, Ray Snow and William Stack for original photography.

And finally, to my friends and correspondents throughout the world who as arms experts, collectors, fighting men and war correspondents have encouraged and assisted me in the preparation of this book.



# AUSTRIAN STEYR 9-MM PISTOL



**(This Pistol is widely used in Balkans and Austria)**

**Caliber:** 9mm Steyr. Note: This is a special 9mm cartridge.

**Magazine:** Is not removable. Located in handle, but cartridges must be stripped into it from the top of the pistol.

**Capacity:** 8 cartridges.

**Muzzle Velocity:** 1200 feet per second.

**Weight of Bullet:** 116 grains.

**Muzzle Striking Energy:** 370 foot pounds.

**Barrel Length:** 5".

**Overall Length of Pistol:** 8 1/2".

**Weight of Pistol:** 18 1/2 ozs.

**Sights:** Fixed.

**Accurate Range:** 75 yards.

**Maximum Range:** About 1800 yards.

**Pistol Operated By:** Recoil.

**Locked:** By cam ribs on barrel which lock in cam slots on inside of top of slide. As bullet passes down barrel, barrel tends to twist to the right. As barrel and slide move to the rear under recoil, cam rib twists barrel to the left and opens lock permitting slide to continue backward and function the action.

**Type of Fire:** Single shot only.

**Magazine Loading Arrangement:** Clip guide on top of slide permits insertion of loaded clip when action is opened.

**Position of Slide When Last Shot is Fired:** Open.

**Safeties:** (a) A thumb safety somewhat like that on the Colt .45 Automatic will be found on the left side of the pistol just below the hammer. Turning this up into its notch in the slide makes the pistol safe. (b) An automatic disconnecter on the right side of the pistol under the slide prevents this pistol from being fired until the action is wholly closed. Note: This pistol resembles the Colt .38 Automatic, and to some extent, the Colt .45 Automatic in exterior appearance. However, its locking and loading arrangements are entirely unique.

## NOTE ON AMMUNITION

This cartridge has an overall length of 1.37 inch. Parabellum (or Luger) 9mm type cartridges have an overall length of 1.14 to 1.16 inch. Thus the 9mm Steyr cartridge will not function in weapons designed to handle the Luger type cartridge. The Steyr bullet is lead with an actual steel jacket (not alloy cased), and although this jacket is plated over, these cartridges rust very readily. The range and penetration is exceptionally great. It is very widely used in Austria and in the Balkans.

## INSTRUCTIONS FOR LOADING AND FIRING



1. **To open magazine:** Grip the milled surfaces at the rear of the slide and pull the slide sharply to the rear. It will stay open if the pistol is empty.

2. **To load magazine:** Place a clip of cartridges (they come 8 to a clip) in the clip guide. Exert firm downward pressure on cartridges and strip them into the magazine.

3. **Pull out empty clip.** Press down the slide release stud which is directly above left hand stock. Slide will go forward automatically loading the firing chamber.

4. **When last shot is fired:** Magazine follower will push up magazine stop and hold slide open.



# AUSTRIAN STEYR 9-MM PISTOL

## FIELD STRIPPING

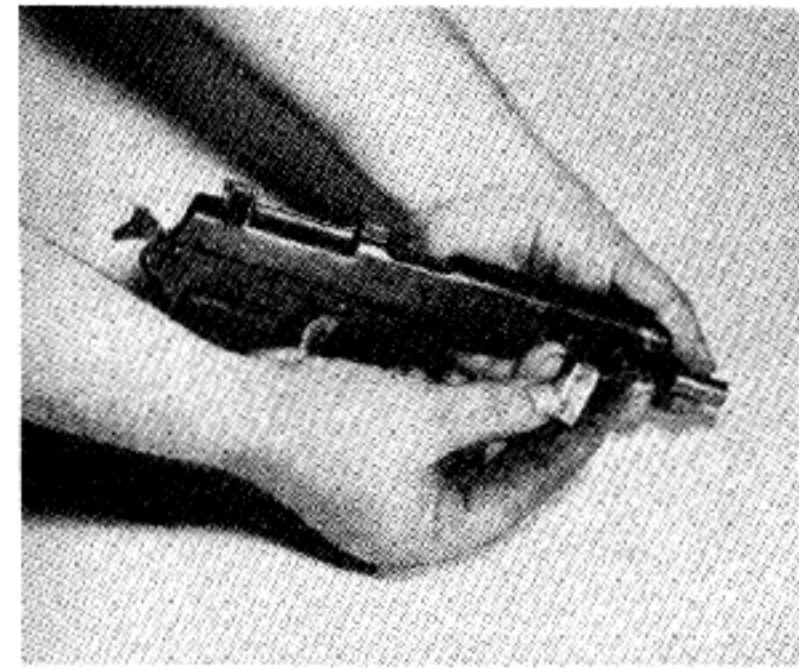

1. At lower front of slide is a spring locking block. Press together its spring points which protrude on the left side of the pistol, and push through and extract from the right side. Be careful that recoil spring and its housing do not slide from

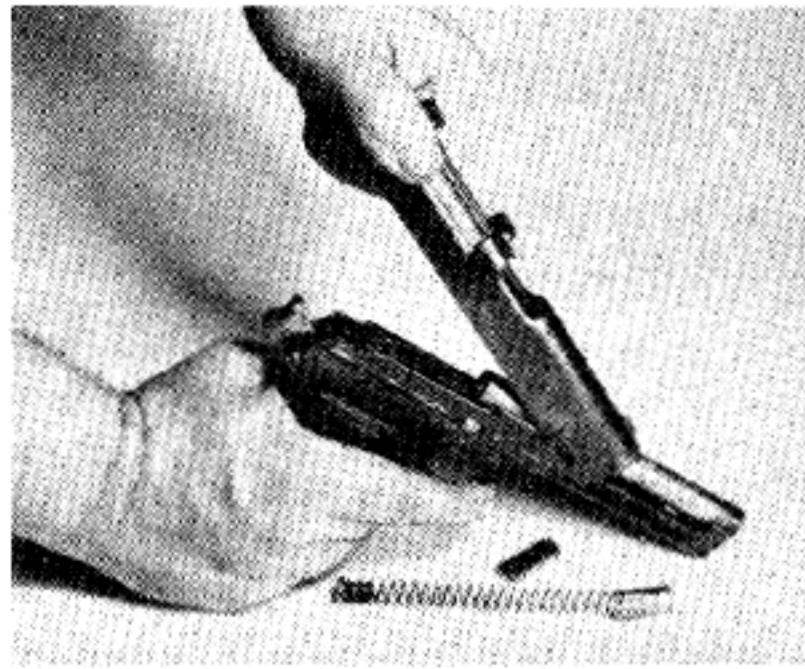

pistol. Ease them out.

2. Now pull slide back about 2" then raise and draw back and up. It can thus be lifted clear of the receiver. Barrel can now be lifted out.

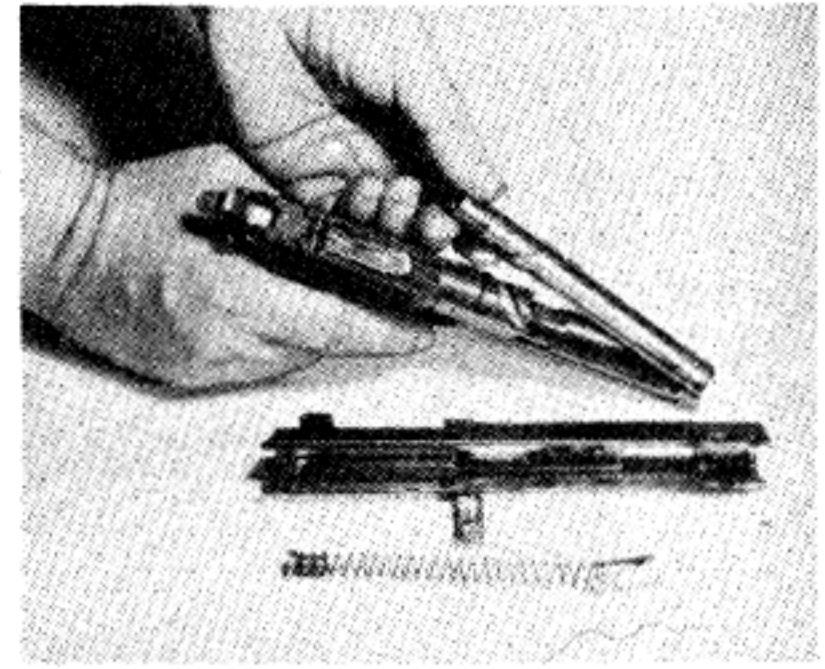

## HOW THE STEYR AUTOMATIC PISTOL WORKS

Starting with the Pistol loaded and cocked, the action is as follows: The trigger being pressed, the hammer strikes the firing pin, driving it forward to explode the cartridge. The bullet following the rifling down the barrel tends to turn the barrel to the right, locking it securely to the locking slot in the slide. Under the rearward action of the recoil, barrel and slide recoil together a short distance when the barrel is stopped against the barrel stop. The cam surface on the barrel riding on the cam rib in the receiver, twists the barrel to unlock it from the slide. The slide goes on back carrying the empty cartridge case gripped by the extractor; the empty cartridge case strikes against the ejector and is hurled up and out of the pistol. The magazine spring forces the next cartridge up in line with the bolt. The rear of the slide pushes up and over the hammer bring it to full cock. The hammer is held by the sear. The disconnector is held down preventing trigger from en-

gaging with sear and hammer.

During all this action, the recoil spring has been compressed; this compression being brought about by the combination locking piece and recoil spring compressor riding back in a slot under the slide and pressing against the recoil spring housing. The rearward motion is now completed.

**Return Movement of the Action:** The compressed recoil spring now pulls the slide forward driving a loaded cartridge from the top of the magazine into the firing chamber. The slide connects with the rear face of the barrel forcing it forward and revolving it in its camming rib, twisting the locking lugs on top of the barrel into place in the locking slot in the slide. As the breech closes, the disconnector moves up into its groove connecting the sear and the hammer, and the weapon is now ready to fire another shot by pressure of the trigger.

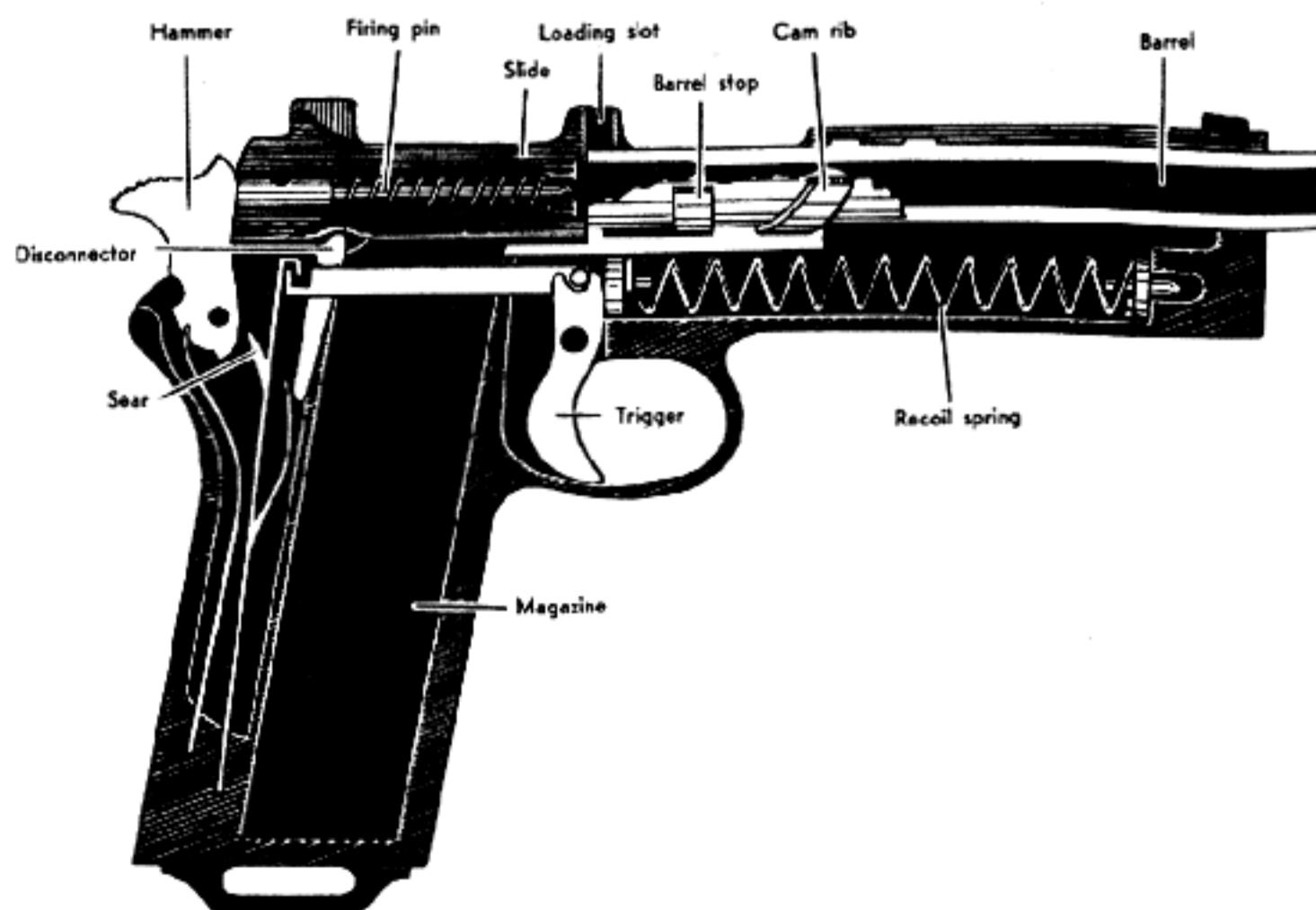



# AUSTRIAN STEYR-MANNLICHER 8-MM RIFLE AND CARBINE

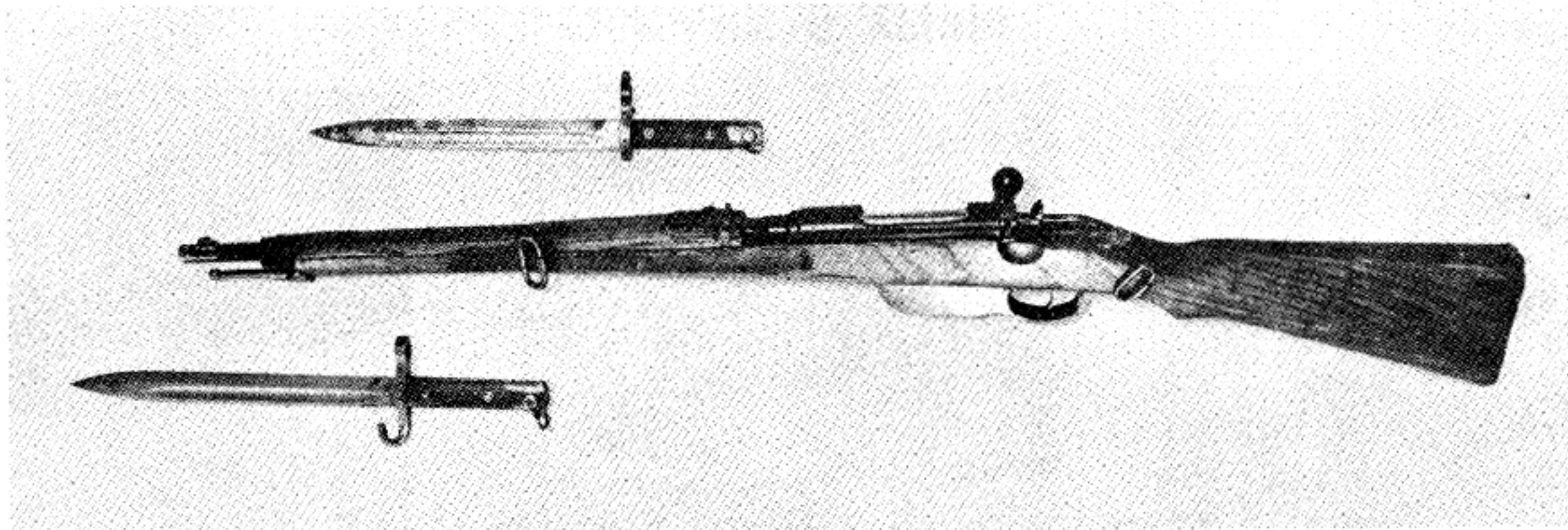

This weapon is in very wide use in eastern Europe. It is the official Rifle of Austria and Bulgaria. It is a straight-pull rifle having very little in common with other types. Its effective operation requires special knowledge.

**Caliber:** 8mm Austrian Service cartridge.

**Barrel Length:** About 30 inches.

**Overall Length:** 4' 2". With bayonet 9 1/2" longer.

**Weight:** About 8 lbs. 6 oz.

**Sights:** Barleycorn front and V-notch open rear adjustable from 300 to 2600 meters. No wind gauge provided.

**Operation:** The bolt on this rifle is drawn straight back to the rear to unload and thrust straight forward to load. Note that this bolt handle does not turn.

**Rate of Fire:** Because of the straight-pull action, the rate of fire of 35 unaimed shots per minute is possible with this weapon.

**Magazine:** Mannlicher type. The clip and 5 cartridges are inserted from the top. When the last cartridge has been chambered, the empty clip falls out the bottom of the rifle.

**Note on Carbine:** Carbine is identical with rifle except for length and weight. The weapon illustrated is the carbine.

**Safety:** Thumb safety at rear of weapon.

**Cutoff:** None possible with Mannlicher magazine system.

**Magazine Follower:** Together with its spring may be hinged forward from bottom of rifle to permit cleaning.

## LOADING AND FIRING



1. Pull bolt handle straight back to the rear as far as it will go. Insert Mannlicher-type clip loaded with 5-cartridges in top of receiver. Press down into rifle exerting the pressure across the rear of the cartridge and the two upper lips of the clip so that the clip will go in with the cartridges. A spring arm from below presses against the bottom cartridge and is free to ride up in a slot between the two sides of the cartridge clip.

2. Push bolt handle straight home as far as it will go. Weapon is now ready to fire.

**Note on the Steyr Straight Pull Action:** The bolt in this type of action is complicated by comparison with the turning-bolt type. This type of bolt action has never achieved wide popularity. While in theory it is very much faster to operate than a turning bolt, in actual practice the British-type rifle can be operated as fast or perhaps even faster. This is due to the fact that in the turning bolt, the primary extraction of the fired cartridge case, which is fitting very tightly in the chamber, is achieved by the direct leverage of the bolt



# AUSTRIAN STEYR-MANNLICHER 8-MM RIFLE AND CARBINE

handle in its upward movement. In a straight-pull type, this leverage is not present.

As the bolt handle is pulled straight to the rear the full cylinder is prevented from revolving by its ribs which ride in the grooves of the receiver; and by centers engaging in the undercut groove in the tang. The bolt head cannot come back until the locking lugs have been turned out of their recesses in the receiver, which is brought about by a turning motion given to the tail of the bolt head by the feathers machined in the inside of the bolt cylinder working in the bolt head tail.

When the locking lugs clear their recesses in the receiver, they are in line with the ribs in the bolt cylinder and so the whole bolt can travel directly to the rear. Incidentally the first motion of the bolt to the rear provides the first compression to the mainspring.

A Canadian rifle, the Ross, using the straight-pull principle was employed for a time in the Canadian Army during the first World War. It was not a satisfactory weapon. Switzerland uses a straight pull rifle known as the Schmidt-Rubin.

## FIELD STRIPPING

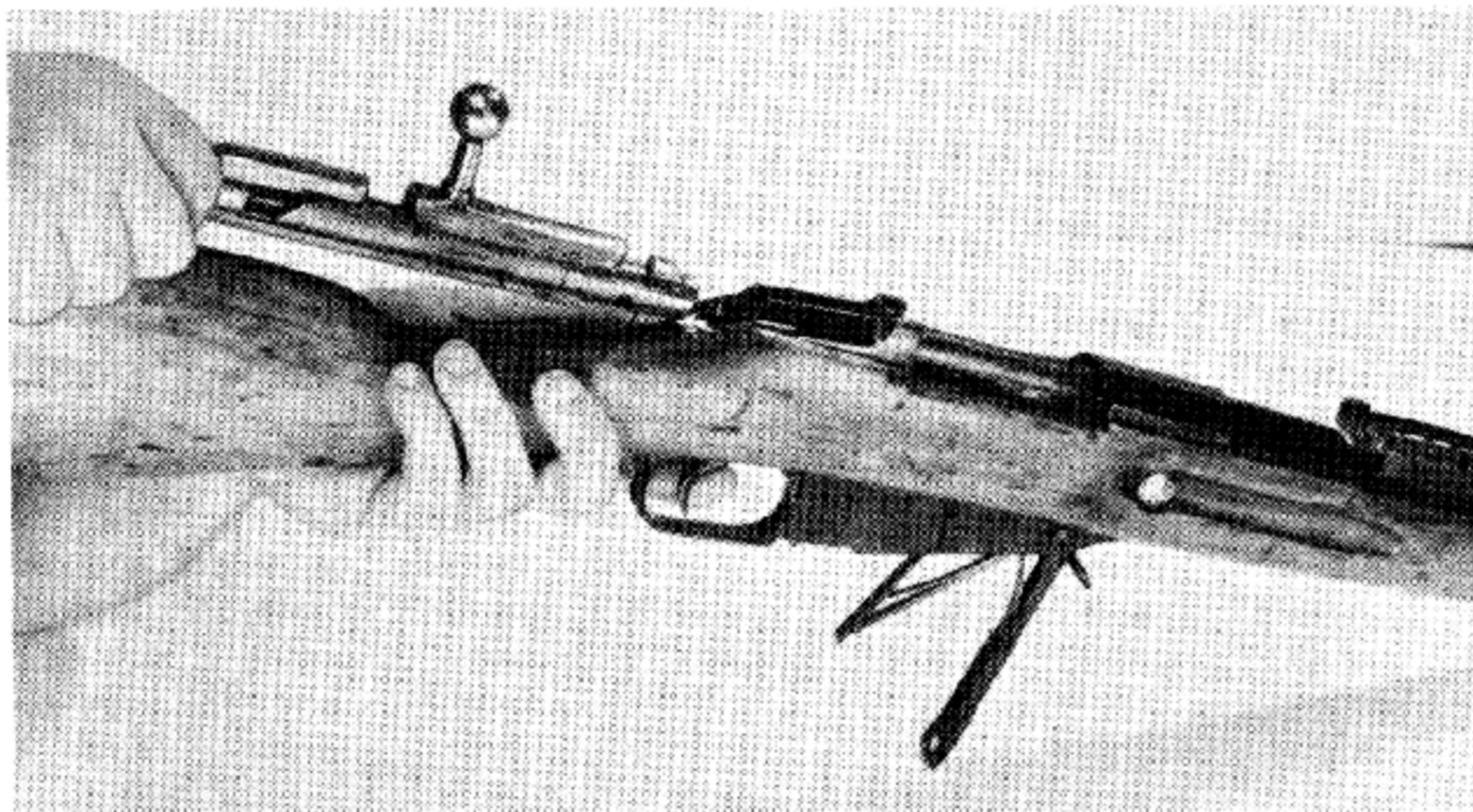

Press the spring retaining catch on the bottom of the magazine just ahead of the opening through which the empty clip drops. This will permit you to hinge forward and downward the magazine bottom together with the follower and the supporting arm and spring.

Pull the bolt handle straight back as far as it will go. Press the trigger, and while holding it, pull straight back on the cockingpiece which will permit the removal of the bolt from the rifle.

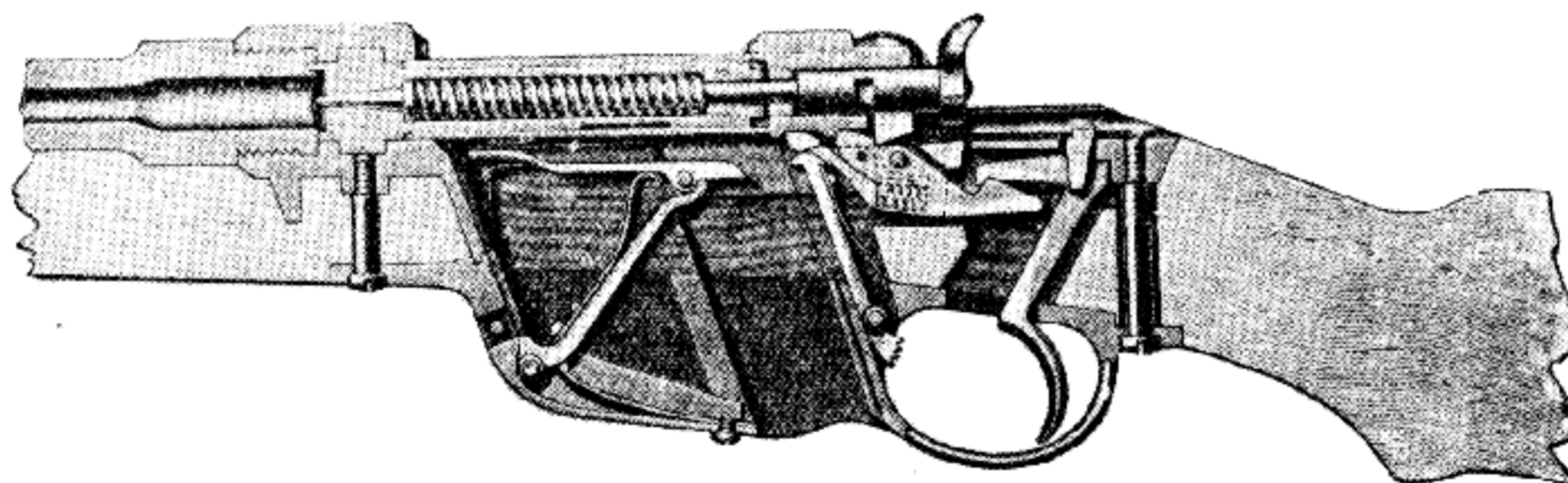

Bolt Forward: Magazine Empty

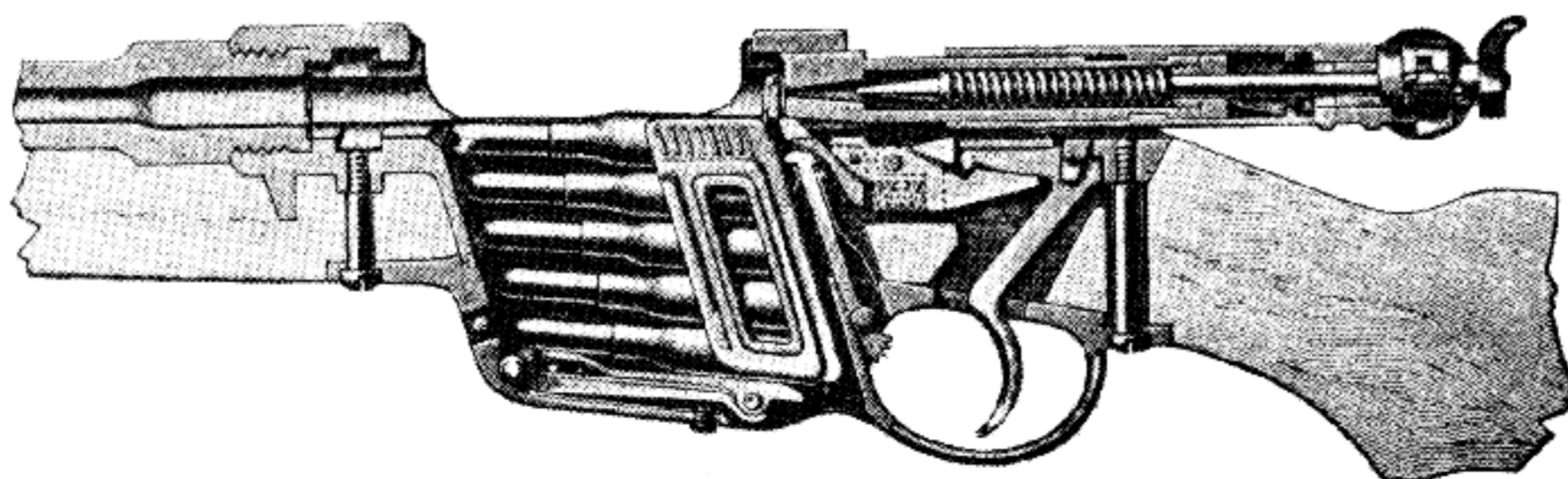

Bolt Rear: Magazine Loaded



# AUSTRIAN SCHWARZLOSE 8-MM MACHINE GUN

## HOW THE GUN WORKS

Starting with the gun loaded and cocked the action is as follows: Safety catch being pushed over to the left by the thumb, the thumb trigger is free to be pushed in. As soon as pressure is released on the thumb trigger, safety slips back into place automatically stopping the firing and locking the firing mechanism. When the trigger thumb piece is pressed in, the trigger bar is drawn down to the rear and the firing pin extension disengaged from a place in the breech block. A stud on the breech block link keeps the firing pin extension from slipping out of engagement with the bent until the breech block is almost entirely home.

A well in the top of the cover, directly ahead of the front sight is kept filled with oil; and a fine spray of lubricant is forced over each cartridge as it is driven into the firing chamber by the breech block. This lubrication is extremely important in guns such as this, and in the American Thompson submachine gun, since absolute uniformity of feeding is necessary when the gun is unlocked.

When the cartridge in the firing chamber is discharged, the bullet goes down the barrel. Note that the barrel in this gun is very short. This is a necessary factor in an inertia operated gun. If the barrel were very much longer, the action would open before the bullet had left the muzzle, and the results might be disastrous.

The moving parts in this weapon are extremely heavy, and the recoil spring which must be compressed is unusually powerful. Further resistance is offered to the opening of the breech by an **elbow joint attached to the breech block** which has another arm pivoted to a **fixed axis in the receiver**.

During the backward movement of the breech block, this elbow joint moves through an arch and since there is a very small angle between crank link and crank when the breech is closed, much of the force of the recoil is transmitted to the fixed axis of the crank and crank handle in the receiver. The striker is cocked during the backward action by a cammed toe on the crank link which acts against a corresponding toe on the striker. Note: Because of the nature of the recoil spring, assembling this gun is a two-man job at the least. While the assembly steps are comparatively simple, it is necessary for one man to guide the recoil spring while the other attaches the rotating butt cap.

**Note:** A light model of this gun is also in use. It has no water jacket; but in other essentials is the same as the heavy model described.

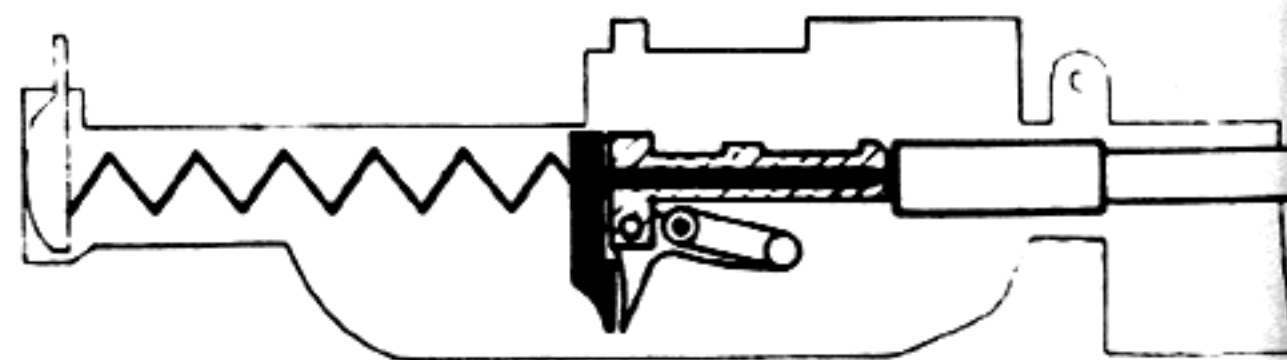
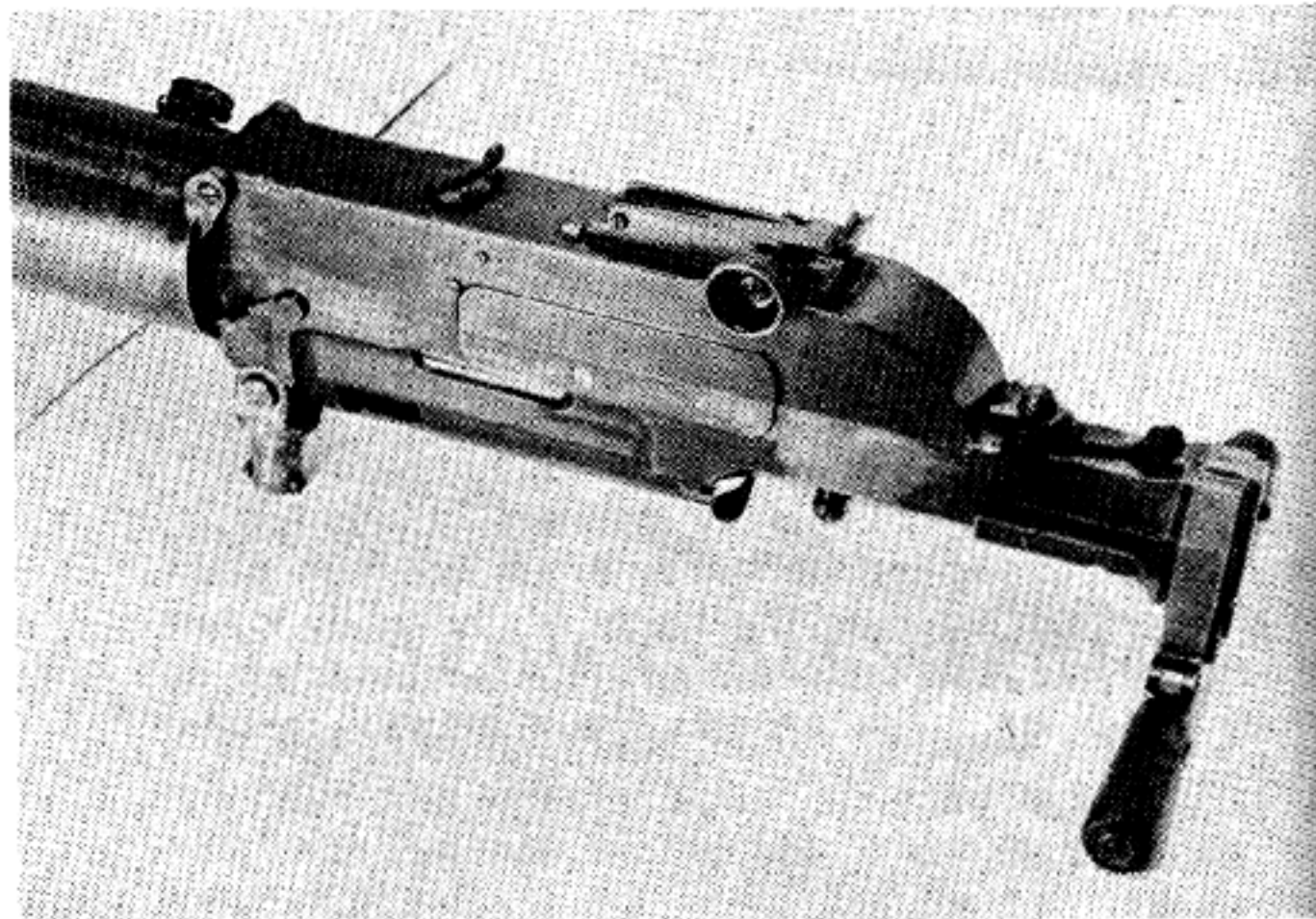

Position of Parts at Instant of Firing

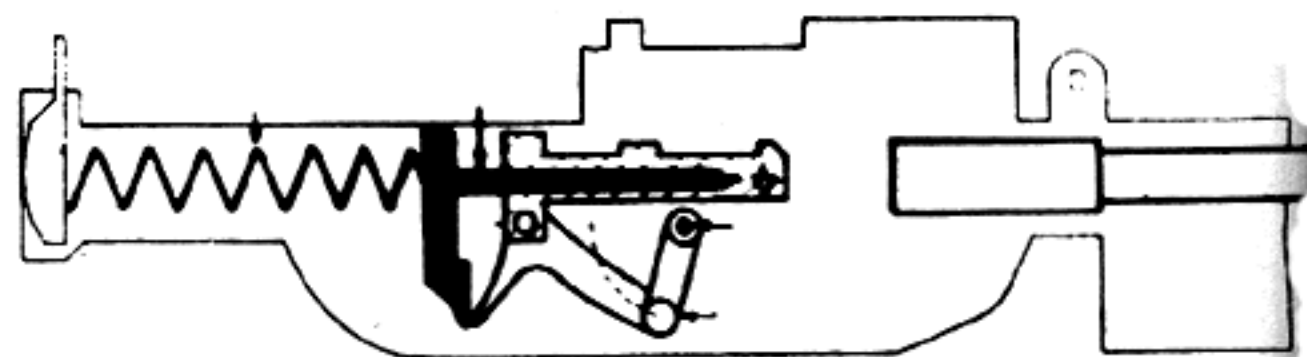

Hesitation Position of Parts



# BELGIAN BROWNING LONG 9-MM AUTOMATIC PISTOL



**Note:** This pistol is popularly known in Europe as the F. N., from the initials of the factory where it was originally made near Liege, Belgium. The factory was the Fabrique Nationale de Armes de Guerre. Pistol was manufactured and sold throughout Europe under Browning patents, while pistols of the same design were manufactured and sold under those same patents in the United States by the Colt Patent Firearms Company.

**Caliber:** 9mm Browning Long.

**Magazine:** Removable box type in handle, capacity 7 cartridges.

**Muzzle Velocity:** 1110 feet per second.

**Weight of Bullet:** 110 grains, metal jacket.

**Striking Energy:** 300 foot pounds.

**Barrel Length:** 5".

**Overall Length of Pistol:** 8".

**Weight of Pistol:** 32 ozs.

**Sights:** Fixed.

**Accurate Range:** 50 yards.

**Pistol Operated By:** Recoil.

**Locked:** Blowback type, unlocked. Breech is closed during period of high pressure entirely by weight of sliding members and recoil spring.

**Type of Fire:** Single shot only.

**Magazine Release Catch:** On bottom of butt at rear.

**Position of Slide When Last Shot Has Been Fired:** Open. Inserting a loaded magazine and pulling back slightly on the slide will let the action go forward again and load the firing chamber.

**Safeties:** (a) Automatic safety in grip which disengages when pistol is held firmly in hand. (b) Thumb safety above left stock. Pushing it up into its notch in the slide provides a positive safety.

## LOADING AND FIRING

1. Insert loaded magazine in handle and push forward until it locks.

2. Pull slide back to the rear as far as it will go, release it and permit it to run forward driving a car-

tridge in to the firing chamber.

3. This differs from the customary Colt pocket pistol only in that the slide stays open when last shot has been fired.

## FIELD STRIPPING

1. Pull slide back as far as it will go and turn safety up into locking notch in the slide. Note that this is the **second** or **dismounting notch**, not the **safety notch**.

2. Twist the barrel **one quarter turn**.

3. Holding firmly onto the slide, press down the safety and let the barrel, slide, and slide spring assembly come forward on their guides out of the receiver.

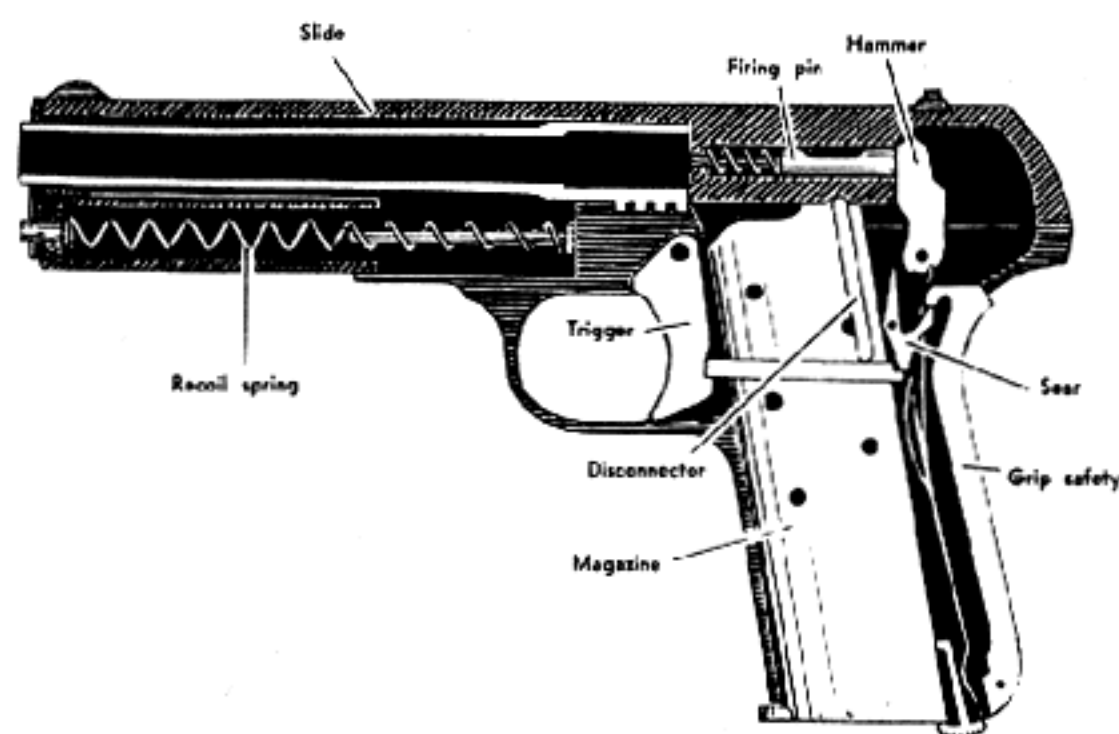



# BELGIAN BROWNING LONG 9-MM AUTOMATIC PISTOL

## HOW THE BROWNING AUTOMATIC PISTOL WORKS

The slide being drawn back against the tension of the coil spring under the barrel, its breech end lies over the enclosed hammer which is hit by the exterior shape of the rear of the slide. The hammer is held cocked by the sear. The magazine spring raises a cartridge into line with the breechblock.

The slide being released, the coil spring drives it forward to strip a cartridge into the firing chamber. During the forward motion the disconnecter is forced downward preventing the trigger from engaging with

the sear until the slide is in its foremost position. Then the disconnecter arises to enable the trigger to function.

Note that both the trigger and the grip safety must be squeezed before the sear will release the hammer to strike against the firing pin and fire the cartridge.

The pressure of the recoil spring moving forward, together with the natural inertia of the slide, delay the opening of the breech until the bullet has passed out of the barrel.

## NOTE ON AMMUNITION FOR THIS PISTOL

The 9mm Browning Long is a freak cartridge widely used in Europe but never manufactured in the United States. It cannot be used in any American made pistols. It is a semi-rim automatic pistol cartridge with ballistics

mid-way between the .380 Automatic Colt pistol cartridge (which is a pocket type), and the .38 Automatic Colt pistol cartridge (which is a high velocity military cartridge very popular in Spain and in South America).

## OTHER CALIBER OF THE F. N. BROWNING

Smaller models of this pistol are also manufactured in 6.35mm (.25 Colt Auto.), 7.65mm (.30) and 9mm Browning (.380 Colt Auto.). These are not military pistols by any accepted standards. But as the F. N. factory

has produced over 1,500,000 pistols in the last 35 years, a working knowledge of their models may be considered of military importance. It is to be noted that officers in European armies very often carry small, pocket type pistols.



# BRITISH ENFIELD .380 PISTOL NO. 2

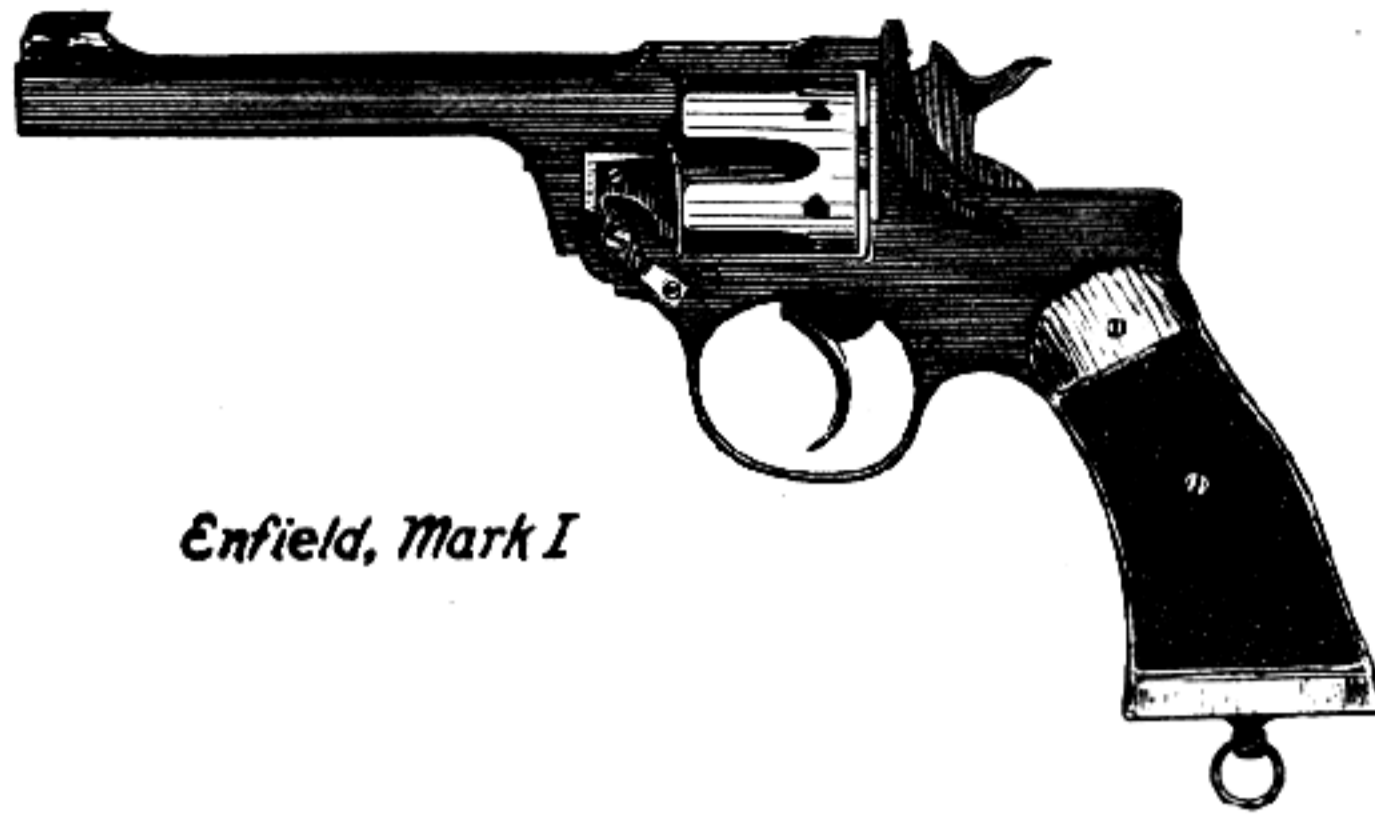

*Enfield, Mark I*

**Caliber:** British .380-inch.  
**Cylinder:** Capacity 6 cartridges.  
**Muzzle Velocity:** About 600 feet per second.  
**Weight of Bullet:** 200 grains, lead.  
**Muzzle Striking Energy:** About 190 foot pounds.  
**Barrel Length:** 5".  
**Overall Length of Pistol:** 9 1/2".  
**Weight:** 27 1/2 ozs.  
**Other Data:** In general same as for pistol No. 1.

**Data on Stripping, Loading, Firing, and Operations,** all about the same as for pistol No. 1. While it has many points of difference in design, it is operated like the No. 1.

**Note:** Pistol No. 2 is produced in two Marks. The common form is Mark I, herewith illustrated. Its design and appearance is very much the same as .455, Pistol No. 1, but many refinements and improvements have been incorporated into its design. The grip is of particular interest. The space behind trigger guard has been made larger to accommodate second finger of the gun hand comfortably; while the incline of the bottom of the frame has been so designed that the trigger guard is partly taken up by the frame metal, providing better support for the revolver as it is held in the hand. (b) Model marked I\* differs from the Mark I model in that the comb of the hammer and the bent of the hammer have both been eliminated. As a result the Mark I\* model will function **only as a double action weapon**; the hammer **cannot** be cocked by the thumb, and the revolver can be fired **only** by pulling straight back on the trigger. This model is intended only for close quarters and rapid fire double action work. It is of very little value over 15 yards range.

**Note on Ammunition for This Revolver:** The ammunition ordinarily issued for use in this revolver is called the British .380 inch. Commercially this cartridge is known as the .38 Webley & Scott Special. However, it will also fire the ordinary .38 Smith & Weston cartridge with 146 grain lead bullets, commercially manufactured in the U. S. Because of difference in the weight of the two bullets, however, the points of impacts of the bullets are entirely different; and separate front sight blades, which may be changed, are issued with this revolver.

The British have officially adopted Pistol No. 2 as the standard issue for the British Forces. After years of checking and experimenting and after close battle studies of the results of revolvers in action, the 200

grain bullet with comparatively low velocity in caliber .380 has proven to be as effective a man stopper as the heavier and bulkier .455. The .38 Smith & Weston cartridge develops a muzzle velocity of 745 feet per second with an approximate muzzle energy of 180 foot pounds.

**Note on Use of Revolver:** In actual battle use it has been found that the lighter weight, better balance, greater accuracy and lower recoil of the .380-inch has resulted in far more effective use of the revolver as a weapon **in the hands of the average man to whom it is issued.** The weight of the heavy bullet and the comparatively low velocity produces a shock effect on impact apparently as effective as weapons of larger bore. Also, the effectiveness of the lead bullet as a man stopper is considerably above that of full jacketed bullets of larger caliber. Note: Full metal-jacketed bullets only are now issued for field use. Lead bullets are classed as dum-dums.

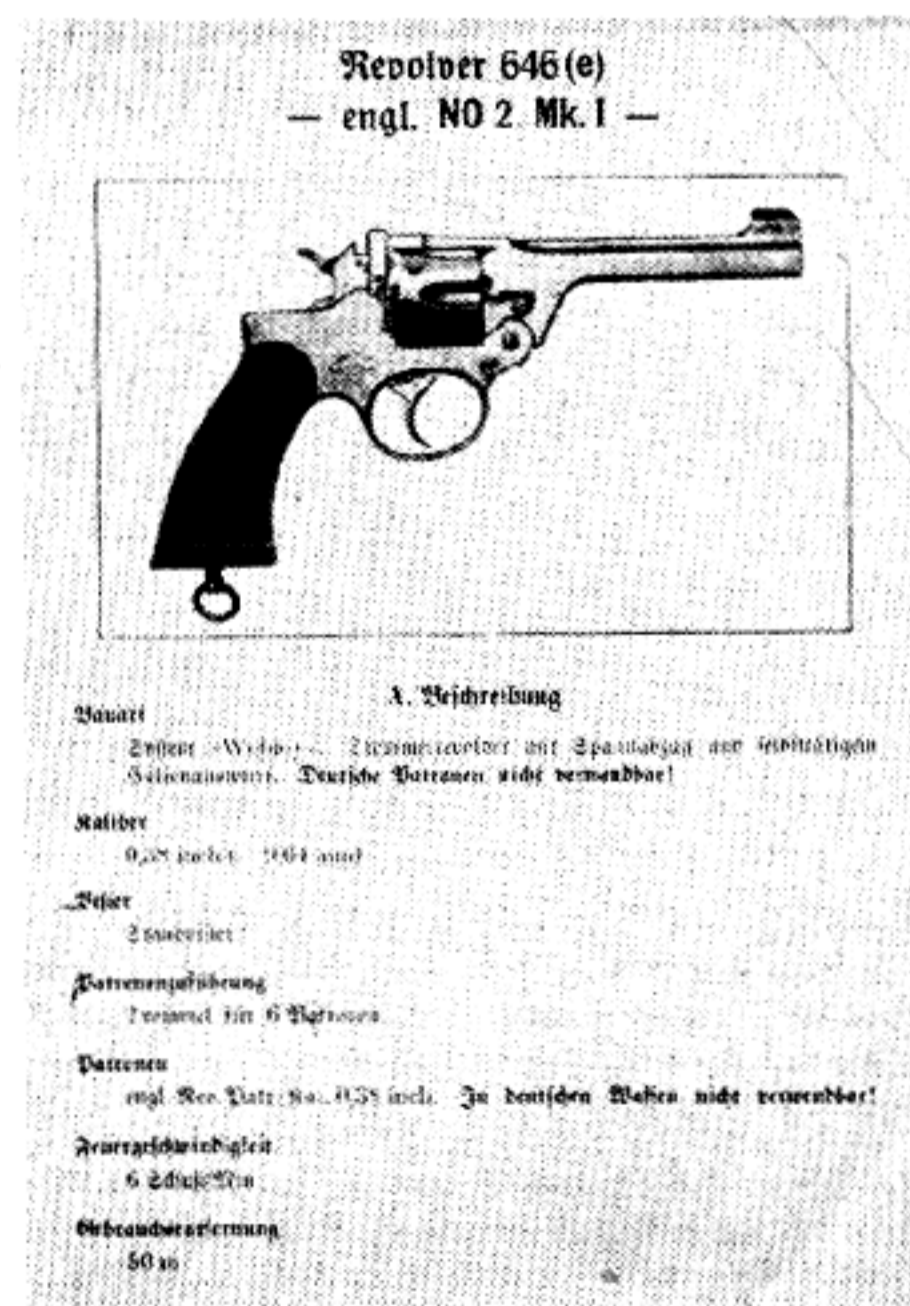

This is a page from a captured German Manual issued to their troops explaining how to use British weapons—in this case the Pistol No. 2.



# BRITISH WEBLEY .455 MARK VI PISTOL NO. 1



## (Pistol No. 1--Standard Revolver of the British Forces)

**Caliber:** .455-Inch Mark VI.

**Cylinder:** 6-Chambers.

**Muzzle Velocity:** About 600 feet per second.

**Weight of Bullet:** 255 grains, metal jacketed. This has a conical bullet with a long slender point. Note: A cartridge called the Mark II, intended for target use only, has a lead bullet weighing 265 grains.

**Muzzle Energy:** About 220 foot pounds.

**Barrel Length:** 6 inches.

**Overall Length of Revolver:** 11 $\frac{1}{4}$  inches.

**Weight:** 2 lbs. 6 ozs.

**Sights:** Fixed.

**Accurate Range:** 50 yards.

**Maximum Range:** About 800 yards.

**Type of Action:** Hinged frame.

**Double Action:** Hammer may be cocked by thumb or may be drawn back and fired entirely by pressure on the trigger.

**Safety:** (a) There is a projection on the hammer nose which prevents it from striking the cartridge unless the barrel catch is fully in place and the revolver securely locked. (b) When the revolver is in the firing position, the cylinder is securely locked by the pawl which engages against the ratchet on the cylinder. This prevents backward rotation. A solid stop on the trigger bears against the end of a groove at the rear of the cylinder, preventing over-rotation. (c) When a cartridge has been fired and the trigger is loosened to permit it to move forward for the next shot, the hammer rebounds automatically, thus withdrawing the firing pin from the head of the next live cartridge. This action is induced by the inclined base of the mainspring auxiliary which under the influence of the mainspring bears against the tail of the hammer.

## INSTRUCTIONS FOR LOADING AND FIRING

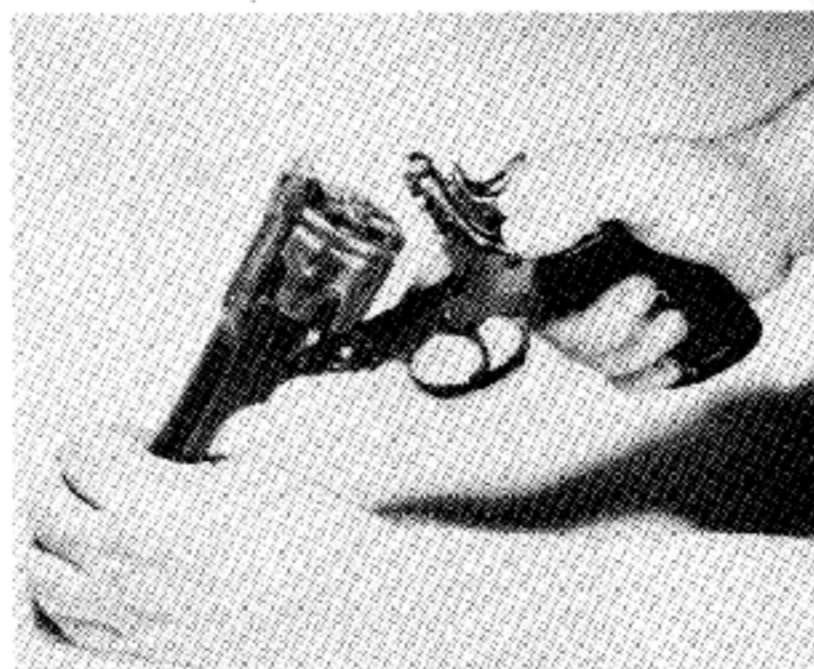

1. Push forward on the curved tail of the pivoted barrel catch which is on the left side of the revolver just below the hammer. As the catch is pushed it pivots on its screw drawing the upper latching end back from over the barrel strap, freeing the barrel to be tipped down on its hinge. As the barrel is bent down, the extractor will rise on its stem until the revolver is fully opened, at which point the extractor under the influence of its spring will slip back into its place in the cylinder.

2. Now load the six chambers. With a little practice this may be done two chambers at a time. If the cylinder is to be only **partly loaded**, remember that the cylinder revolves **clockwise**; and that the first cartridge must be to the **left** of the chamber in direct line with the hammer nose when the weapon is closed. Cocking the hammer automatically turns the cylinder the distance of one chamber.

3. Now turn barrel and loaded cylinder up to the fullest extent. The heavy catch will automatically be sprung over the barrel strap and lock it securely.

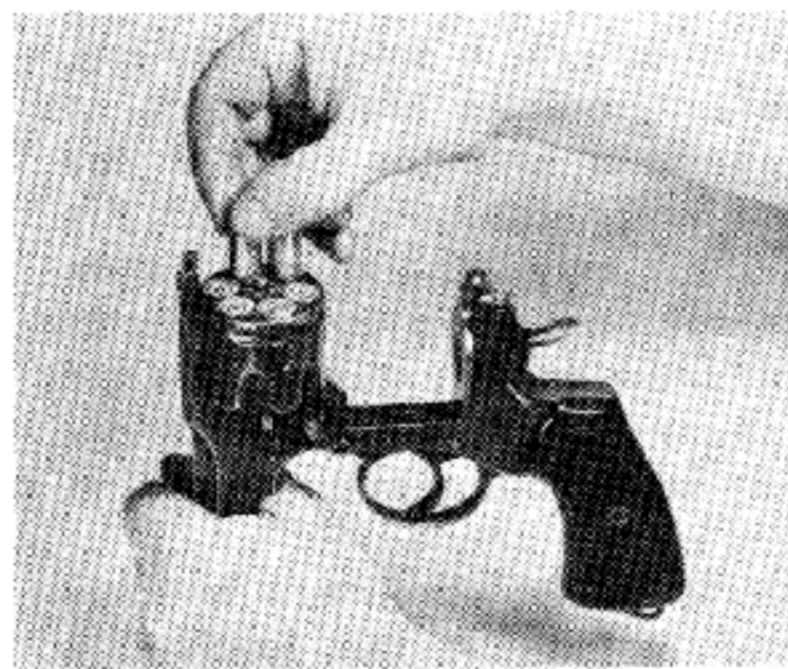

4. If you have time, and accuracy is desired, **always pull back the hammer with the thumb to full cock for each shot**. For close quarters or emergency firing, drawing the trigger straight back will raise the hammer to full cock; turn the cylinder and trip the hammer, completing the firing. It is necessary to release the pressure on the trigger after each shot to permit the mechanism to engage for the next shot. Accurate shooting except at close range is difficult when shooting double action.



# BRITISH WEBLEY .455 MARK VI PISTOL NO. 1

## FIELD STRIPPING

The only stripping necessary and recommended for this revolver is removing the cylinder. The bottom screw at the extreme forward end on the left side of the receiver is the cylinder catch retaining screw. Unscrew this. Now push bottom marked "cylinder catch retainer" directly above the screw **upwards**. This will depress the rear of the catch and permit the cylinder to be lifted out.

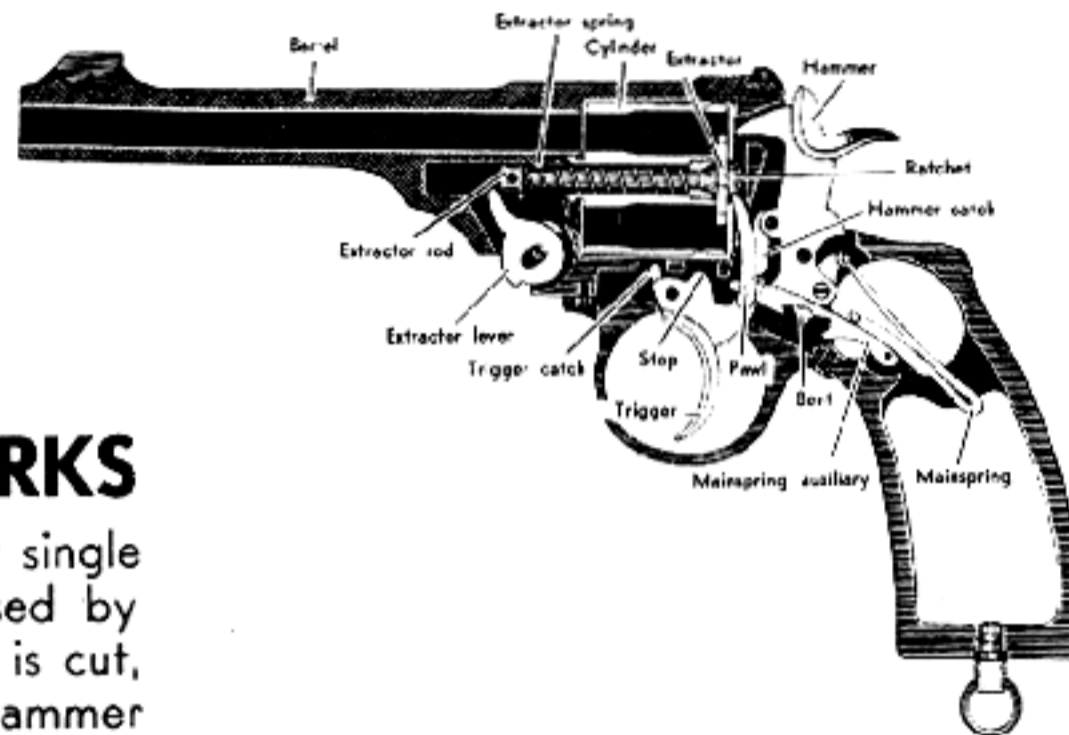

## HOW THE PISTOL NO. 1 WORKS

If the hammer is drawn back by the thumb for single action firing, the rear end of the trigger is raised by the projection on the hammer on which the bent is cut, catching under the trigger nose. Drawing the hammer back compresses the mainspring. The ball is moved upward against the ratchet and revolves the cylinder. When the chamber containing the cartridge to be fired next is in line with the barrel, the cylinder stop engages in a notch in the cylinder and prevents further rotation. Simultaneously the trigger catch rises to its peak in the cylinder, holding the cylinder securely so that it cannot turn in either direction. The trigger nose drops into the bent holding the hammer at full cock. The mainspring is fully compressed when its lower arm is raised by the mainspring auxiliary. When the trigger is squeezed, the hammer falls, striking the primer of the cartridge exploding the charge.

## NOTE ON THE PISTOL NO. 1

Although the British call this weapon a pistol, it is actually a revolver. It consists of a single barrel with a cylinder having chambers for six cartridges. It is one of the finest heavy duty military hand weapons ever made. The combination of heavy bullet and comparatively low velocity, gives a tremendous shock force when the bullet strikes. This weapon is not to be confused with the typical small caliber U. S. hinge-frame revolvers intended for low power cartridges. The locking system on this revolver is very much stronger and much more sturdily built than that of the typical American pocket revolver. It is the only hinge-frame revolver in which it is safe to use heavy powder loads. With a little practice, one will be able to push forward the stirrup of the barrel catch with the thumb of the right hand, snap the weapon down, opening and extracting empty cartridges with one movement of the right hand. In the hands of an expert, this revolver is a most formidable weapon. This is one of the official revolvers of the British forces.



## HOW THE EXTRACTOR WORKS

When the barrel catch has been drawn back and the barrel tipped down, the extractor lever tooth catching against the frame is stopped in its movement. The extractor lever arm stops the motion of the extractor rod, and as the barrel and cylinder move down the extractor is forced up out of its seating carrying with it the cartridges, the rims of which have been resting on the base of the extractor. When the barrel nears its completely open position, a corner of the barrel joint passes over the tooth and presses it to the rear. It is thus forced into the groove in the frame. The extractor spring (wound around the extractor stem) which has been compressed during the downward motion of barrel and cylinder, is now permitted to drive the extractor lever back to its seat in the cylinder.



# BRITISH SMITH AND WESSON .38 PISTOL NO. 2

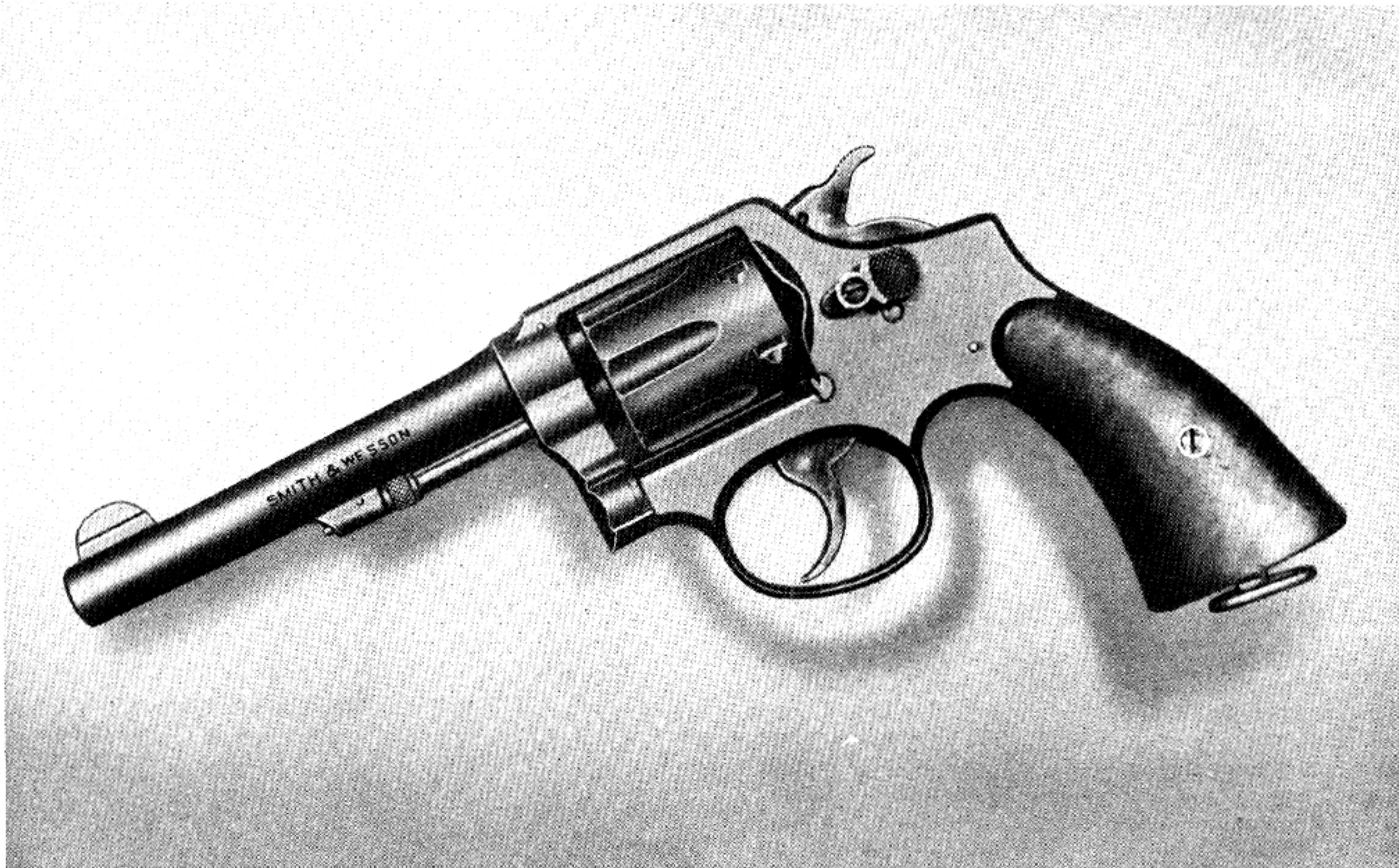

This is an official pistol of the British Forces, issued in tremendous quantities to supplement Pistol No. 2, Enfield Model. It uses the standard British Service .380 inch cartridge. It will also handle the regular .38 S & W cartridge, and the American made .38 S & W with 200 grain bullet.

Note that this weapon will **not** handle the .38 S & W special type cartridges which chamber in the .38 S & W revolver now in use by our Navy and Coast Guard.

This is a favorite Commando weapon. The barrel length is 5 inches.

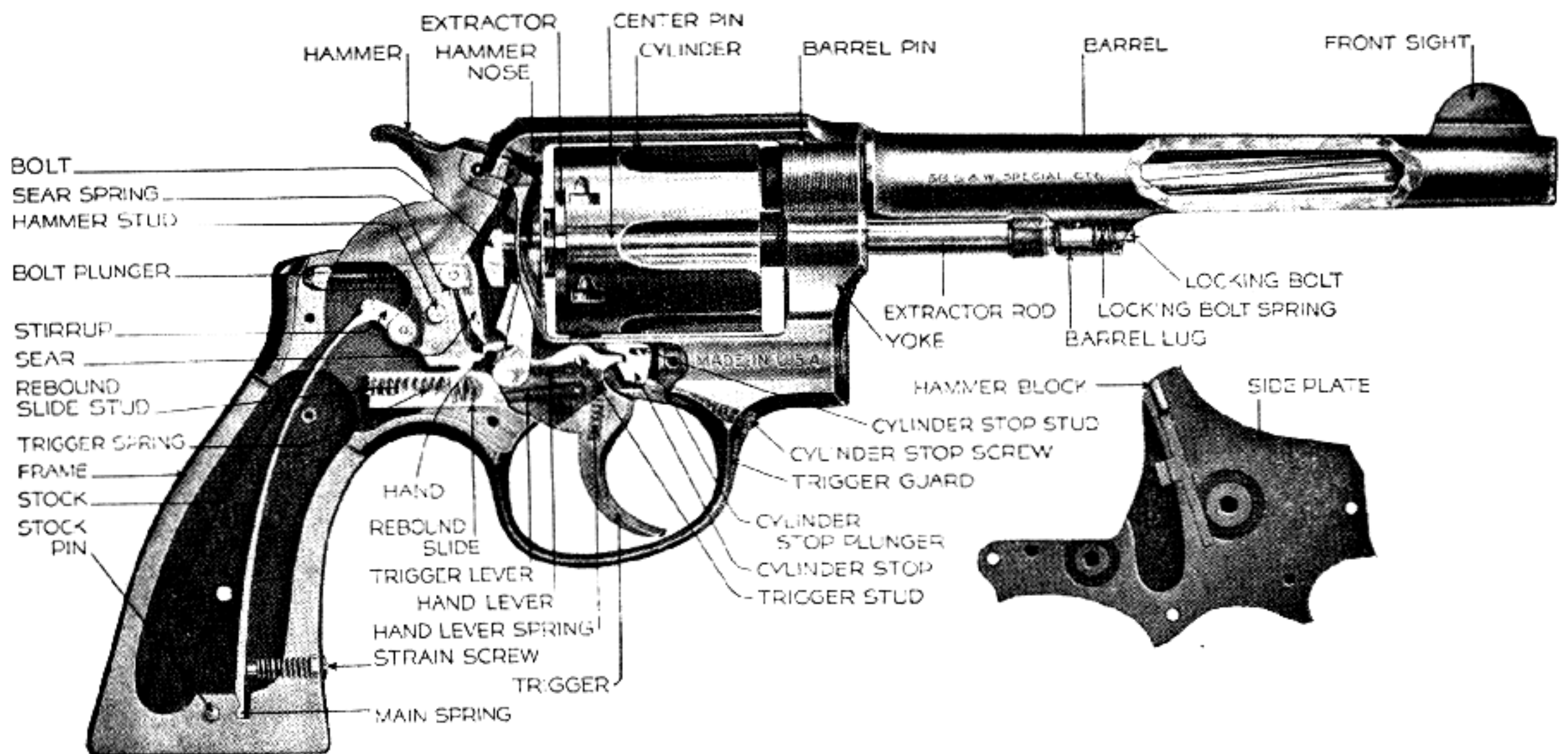

Nomenclature of all S & W Swing-out Revolvers



# BRITISH SMITH AND WESSON .455 REVOLVER

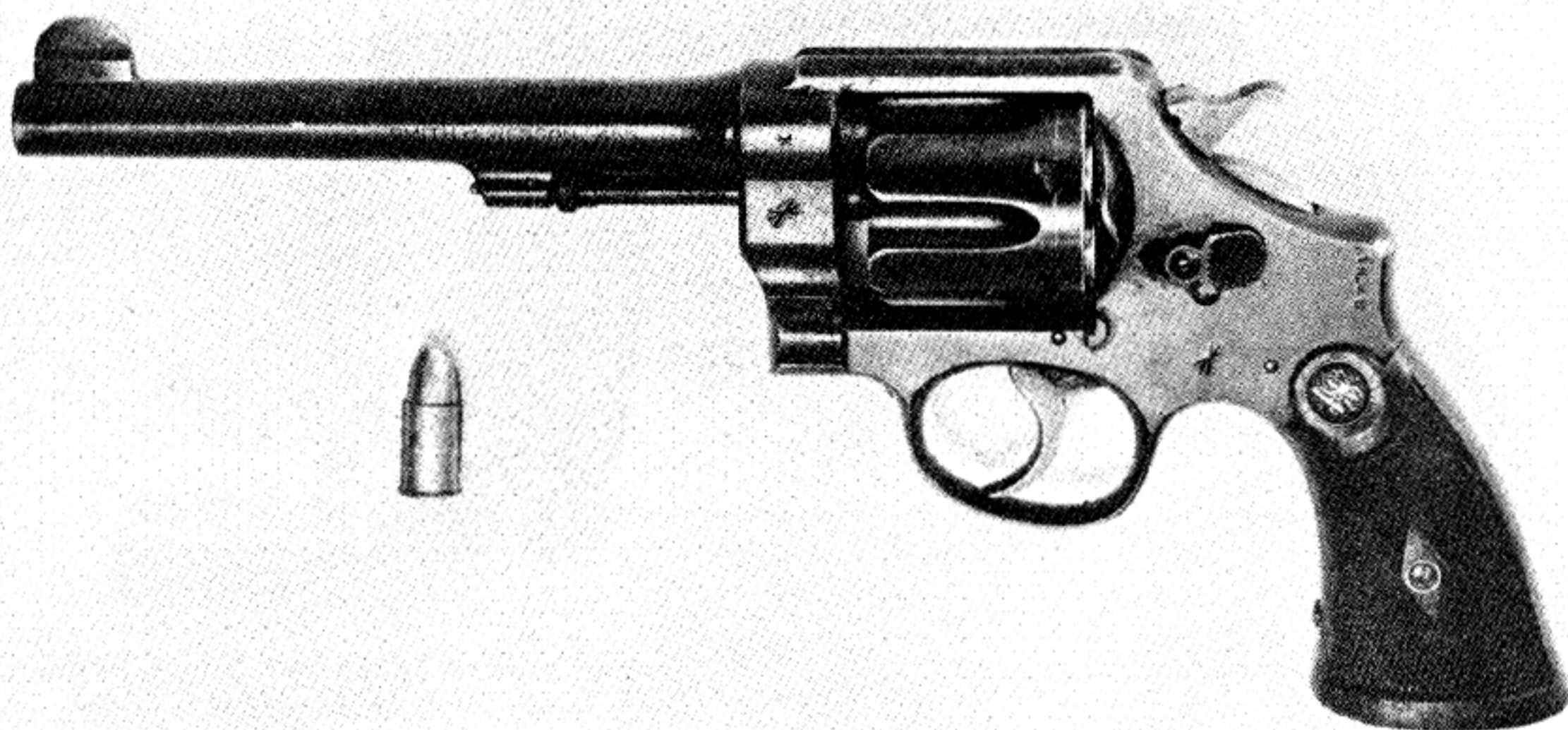

In all essentials this revolver is identical with the United States Revolver Smith & Wesson Model 1917. These revolvers when chambered for the .455 British Service cartridge, will usually be found to have stamped on the barrel ".455 Eley." This cartridge has a bullet weight of 265 grains, a muzzle velocity of about 600 feet per second in the 6½" barrel model illustrated (some models of this revolver have been manufactured in 5" barrels). Muzzle energy is about 220 foot pounds and extreme range at 35° elevation is about 1300 yards. Revolvers of this make and caliber are in very common use in Great Britain and Canada. On some models a housing will be found extending forward from the frame

under the barrel acting as a protector for the ejector rod.

In common with all Smith & Wesson swing out cylinder revolvers, the cylinder on this model may be swung out to the left on its crane by **pushing forward** on the thumb piece mounted on the left side of the revolver. It is fitted with the standard Smith & Wesson locking system with a lock at the rear of the cylinder, plus a second lock at the front of the ejector rod. Both locks are operated by single pressure on the thumb piece. The cylinder revolves counter-clockwise, from right to left.

## OTHER TYPES OF SMITH & WESSON REVOLVERS IN USE IN BRITISH SERVICES

After Dunkirk, huge quantities of all models and calibers of Smith & Wesson (and other) revolvers were hurriedly shipped to Great Britain. No detailed description will be attempted here because all the hinge frame models vary only in relation to caliber, weights and barrel lengths; while all the lower caliber hinge frame models operate on the simple principle of raising the

barrel latch and bending the barrel and cylinder down to extract and load. (The one exception is in the Smith & Wesson Perfected model, on which a thumb piece must be **pushed forward** at the same time that the barrel catch is lifted before the pistol can be opened for extracting and loading.)

## TYPES OF COLT REVOLVER IN COMMON USE IN BRITISH SERVICES

All double-action Colt Revolvers operate on the same principle, the thumb catch on the left side of the revolver being **pulled back** permitting the cylinder to be swung out on its crane to the left. The Colt does **not** have the forward locking device of the Smith & Wesson. The cylinder revolves from left to right, clockwise.

Again, essential differences in models consist almost entirely of variations in caliber, barrel length and weight not in method of operation. Colt Revolvers are not sufficiently different from the 1917 U. S. Army models to warrant any extended consideration here.



# BRITISH WEBLEY .455 AUTOMATIC

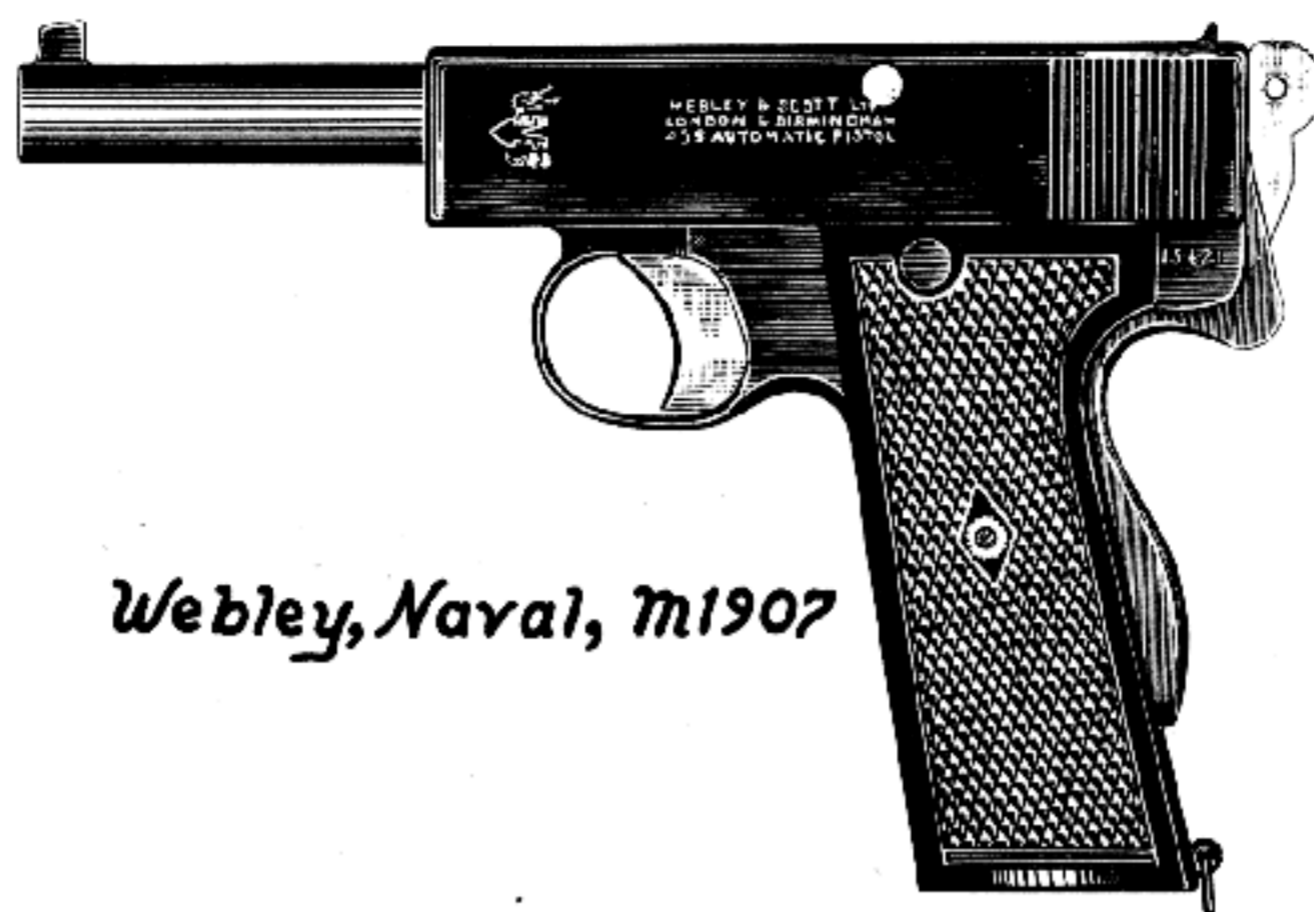

*Webley, Naval, m1907*

**Caliber:** .455 Webley Self Loading Pistol.

**Magazine:** Box type.

**Capacity:** 7 cartridges.

**Muzzle Velocity:** 750 feet per second.

**Weight of Bullet:** 220 grains, metal jacketed.

**Muzzle Striking Energy:** 270 foot pounds.

**Barrel Length:** 5".

**Overall Length of Pistol:** 8 1/2".

**Weight of Pistol:** 36 ozs.

**Sights:** Fixed.

**Accurate Range:** 75 yards.

**Maximum Range:** About 1500 yards.

**Pistol Operated by:** Recoil.

**Locked:** By diagonal inclined planes on the barrel engaging in diagonal grooves on the sides of the slide. Locked barrel and slide recoil together for a short distance, and then the diagonal slots force the barrel down out of locking.

**Type of Fire:** Single shot only.

**Magazine Release Latch:** On underside of butt.

**Position of Slide When Last Shot Is Fired:** Open. Pressing large catch on left side of pistol, lets it run forward.

**Safety:** A safety is provided in the rear of the grip as in the Colt Automatic Pistol. When pistol is held firmly, this grip is pushed in permitting the weapon to be fired.

**Special Feature:** Magazine is provided with **two** catch notches in the magazine, one above the other. Push the magazine **all the way in** and the catch will lock in the **lower** notch leaving the pistol ready for magazine fire. If the magazine is pushed **only part way in** so that the catch locks in the **upper** notch, the pistol can be loaded with single cartridges inserted through the open breech; and action closed by pressing slide release catch. After each shot thus fired the slide will remain open ready for the next cartridge. Meanwhile the magazine remains loaded in the handle held in reserve. To achieve magazine fire it is only necessary to push the magazine in until it catches in the **second** lock notch.

## INSTRUCTIONS FOR LOADING AND FIRING

1. Insert loaded magazine in handle, push in as far as it will go.

2. Grip milled surfaces at rear of slide, pull slide to the rear as far as it will go. Cartridge will rise in line with the breech block. Release the slide and permit the recoil spring to drive it forward pushing a cartridge into

the firing chamber.

3. When last cartridge has been fired: slide will be open by slide stop. Extract empty magazine, insert loaded magazine, press slide release catch on left hand side of pistol and slide will go forward and load the firing chamber.

## FIELD STRIPPING

1. Move slide about 1/4" to the rear and press in recoil lever stop. (This is the small milled stud on the right side of the pistol directly behind the trigger.) This locks the recoil spring out of action.

2. Now push slide forward again. The slide (or breech) stop is now loose as the recoil spring is locked out of action by the recoil lever stop. Pull this out as far as it will go.

3. Displacing the breech stop permits the slide to be drawn directly to the rear. This releases the barrel which can now be lifted out. The slide can now be pushed forward off the receiver.

4. No further dismounting is necessary or recommended.

**Note:** The recoil spring in this pistol is a flat spring positioned inside the handle under the right hand stock. Its pressure is exerted against a hard steel pin extending transversely through the slide and called the recoil lever bar and breech stop. This spring system is not to be compared for reliability with the coil spring system used in our Colt Automatic Pistols. However, it does permit of exceptionally easy dismounting, which is an important factor in giving proper care to any weapon.



# BRITISH WEBLEY .455 AUTOMATIC

## HOW THE PISTOL SELF-LOADING .455 MARK I WORKS

As the cartridge is fired, the locked barrel and slide start backward together. The diagonal inclined grooves on the inside of the slide force the diagonal inclined planes on the barrel **down**, thus swinging the barrel down out of its locking arrangement with the slide. As the barrel stops, the slide continues to recoil in a straight line, withdrawing the empty cartridge case and ejecting

it up and to the front. It rides over and cocks the hammer. At the same time the trigger and hammer action are disconnected, as in automatic pistols generally. In its rearward motion the action compresses the flat spring housed beneath the grips compressing it to provide energy for the forward action of the pistol.

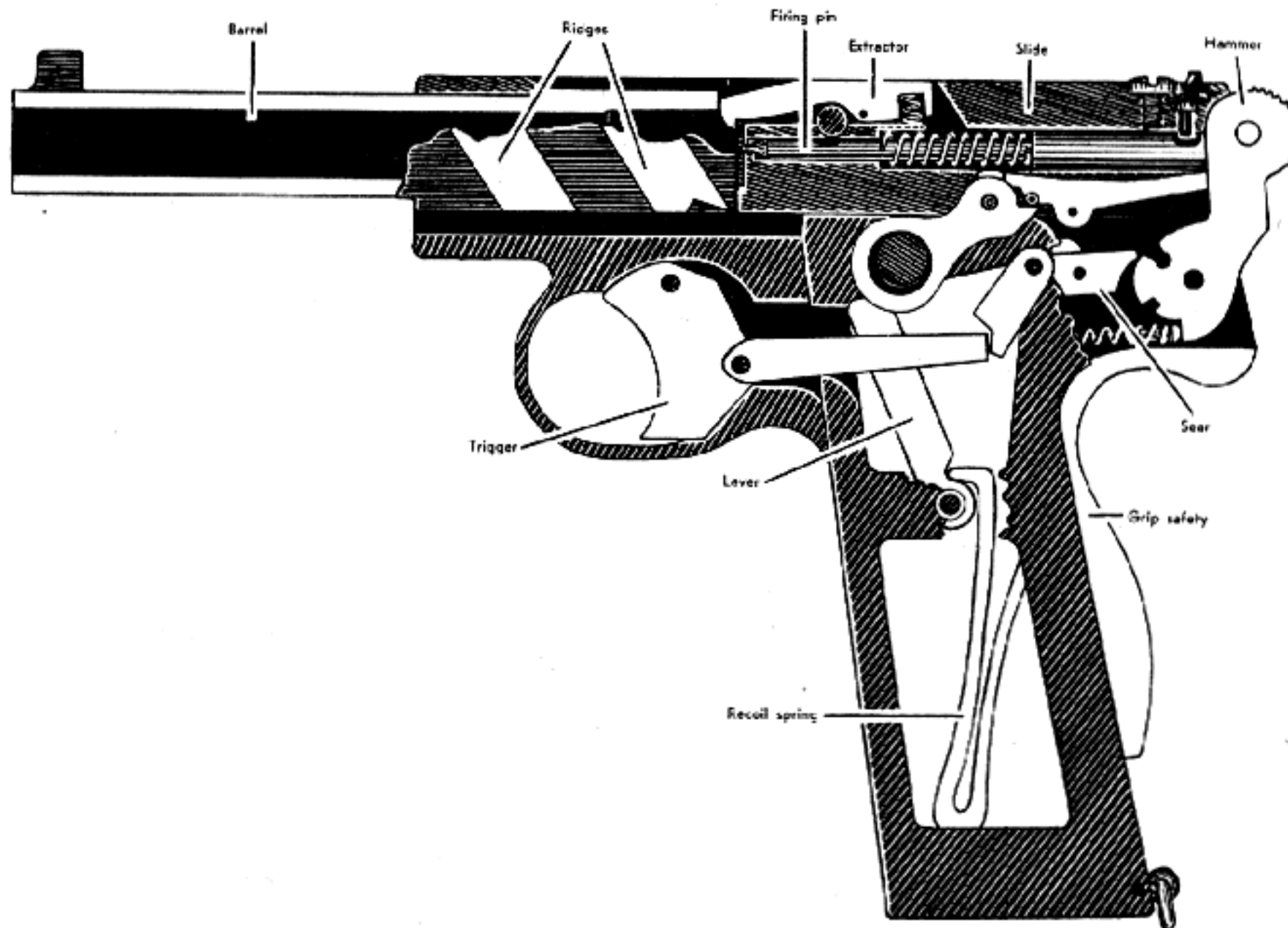



# BRITISH ARMY RIFLES

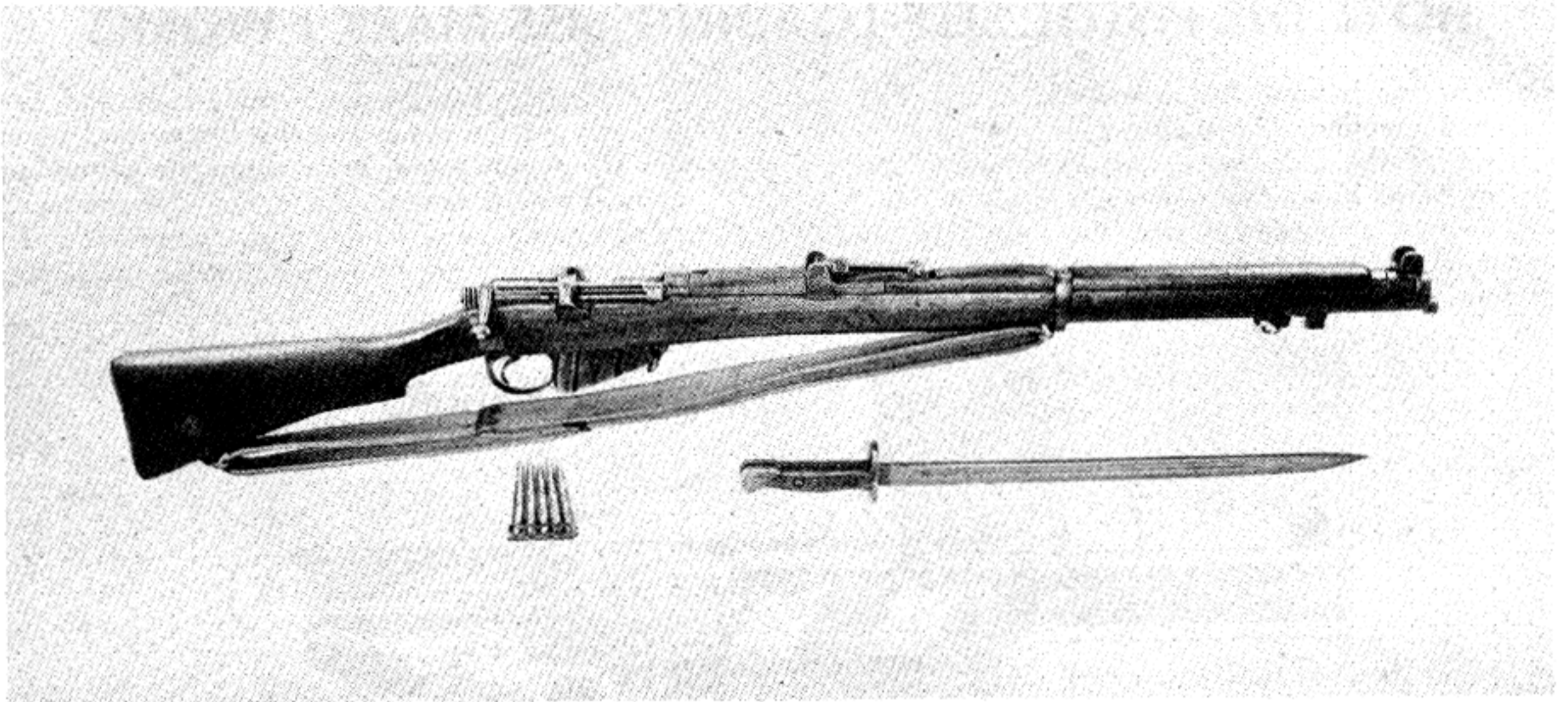

British Mark III Rifle I

Several rifles are in general use in the British Services. Perhaps the most widely used of all the types are the ones officially known as Rifle No. 1 Mark III and Mark III\*. These rifles are popularly known as S.M.L.E. or .303-inch Short Magazine Lee Enfield. These weapons are improved patterns of the original Mark I adopted in 1903 by Great Britain.

A rifle known as the Rifle No. 4, Mark I is now in extensive manufacture throughout the British Empire and is being issued to all divisions of British troops. This rifle is merely an up-to-date production copy of the famous S.M.L.E. In appearance it resembles the previous models very closely. It has been modified to permit

mass production. When the rifle was developed, every attempt was made to lessen the number of machinings necessary in order to save both time and material. Its magazine and safety devices are identical with the earlier model Mark III. The major changes are in the size and shape of the bolt, the sights, weight of barrel and style of bayonet.

Still another type of .303-inch rifle in use in British services is known as the rifle No. III Mark I\* or more simply as the Pattern 14. Except for caliber, this weapon is practically identical with the United States Rifle Model 1917 (Enfield).

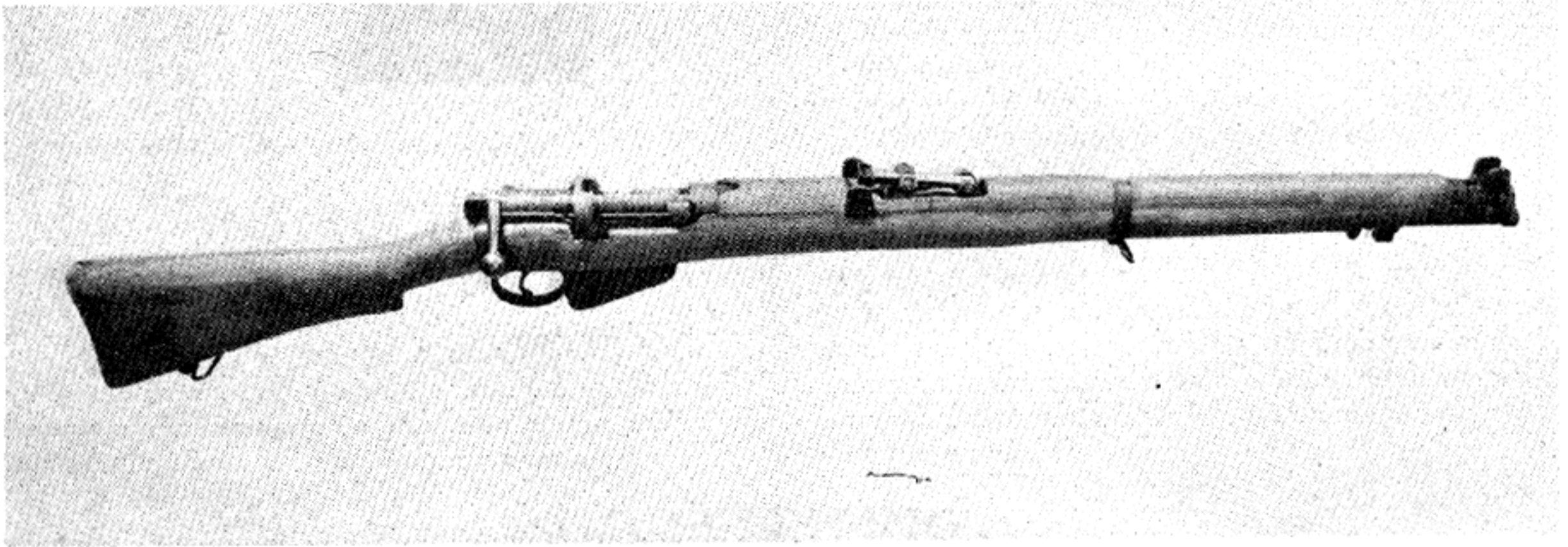

British Mark III\* Rifle I

**.303 inch S.M.L.E.**  
**Caliber:** .303 inch British Service cartridge.  
**Magazine:** Box type, capacity 10-cartridges. Extends through bottom of rifle in front of trigger guard. This magazine is removable. However, it loads through the top of the receiver with 2 five-shot clips.  
**Ballistics:** Standard for British Service cartridges.  
**Barrel Length:** About 25 1/5 inches.  
**Overall Length of Gun:** 3' 8 1/2" (with bayonet 5' 1.7").  
**Weight of Rifle:** 8 lbs. 10 1/2 oz.  
**Sights:** Blade front, open U-notch rear.  
**Adjustable:** 200 to 2,000 yards.

**Locked:** By turning bolt. Lee Enfield type.

**Safety:** On left rear end of receiver.

**Note on Mark III\*:** This model differs from the Mark III only in minor details. It was improved in 1918. No cutoff is provided on this model. There is a magazine cut-off on the Mark III model. Long range sights are not provided on this weapon. In some, but not all models, the cocking piece is shaped differently. In the Mark III\* the rear end of the cocking piece is flat with grooves on each side to give it a grip for finger and thumb. There is no wind gauge on this rifle. A back-sight cap is provided instead.



# BRITISH ARMY RIFLES

## LOADING AND FIRING

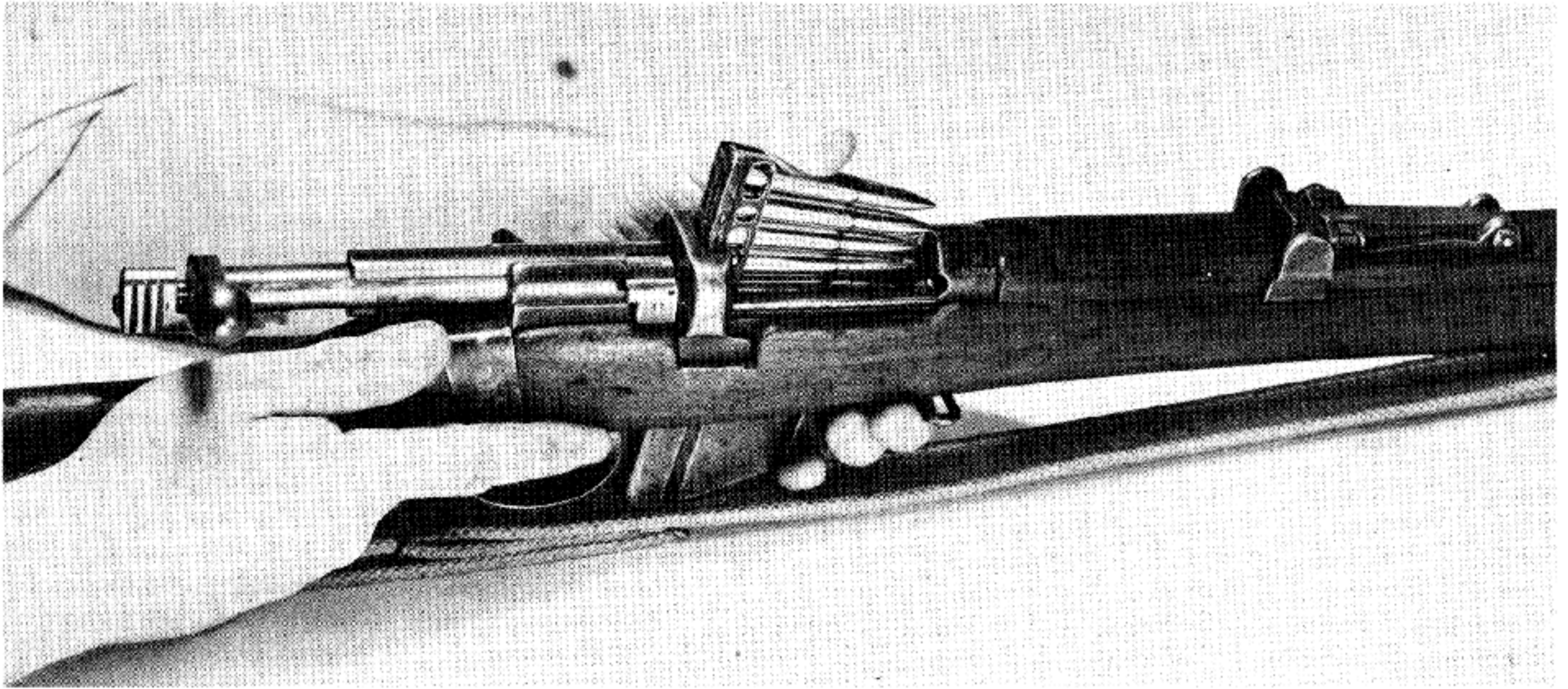

Turn bolt handle up as far as it will go and pull it straight back to the limit of travel.

Insert loaded clip in the clip guide in the receiver and strip the cartridges down into the magazine. Remove the empty clip. Insert a second clip, push these cartridges down and remove clip. This will leave the magazine fully charged with 10-cartridges.

Pushing bolt handle fully forward and down loads the firing chamber, cocks and locks ready for firing with a pull of the trigger.

Unless weapon is to be fired immediately, push the thumb rocker on the left rear of the receiver to "Safe" position.

## FIELD STRIPPING

Remove magazine. This may be done by pushing in or pulling up, as different rifles may require, the magazine catch located in the forward end of the trigger guard. This will release the heavy sheet steel box which may be withdrawn from the bottom of the receiver.

Removing the magazine follower and its spring is simply done. Hold the magazine, open end up, and push the rear of the magazine follower down inside the casing. This will permit you to ease the front end of the follower up and out of the casing and remove it and the spring.

In order to remove the bolt, it is first necessary to rock forward the safety catch just above the rear end of the trigger guard, on the left side of the rifle. Then turn the bolt handle up and turn it back as far as it will go. Catch your right forefinger under the head of the bolt. While using the right thumb, press down on the top of the clip guide to provide a lever action. Pull the bolt head up until it is released from its spring catch. Then withdraw it straight to the rear.

**Note on Replacing Bolt:** These bolts are not interchangeable and the number on the bolt should always be checked against the number on the rifle when there has been any possibility of substitution of another bolt. Before inserting the bolt, be sure that the head is fully screwed home, and that the cocking piece lines up with the lug on the underside of the bolt. Insert the bolt in the boltway and thrust it forward, and then pull it back as far as it will go until the head touches the resistance shoulders and force the bolt head down over the spring retaining catch. Then push it forward to the forward position. Turn down bolt handle and press trigger.





# BRITISH ARMY RIFLES

## HOW THE RIFLE WORKS

Starting with the rifle loaded and cocked, the action is as follows: When the trigger is pressed, it draws down the sear until the sear nose reaches the bottom of the full bent. (This provides the first pull or slack, which is a feature of the best military rifles.) As the trigger pressure continues, the upper part of the sear is drawn still further down until the sear nose clears the bent allowing the cocking piece on the striker to be driven forward by the compressed main spring. The striker nose, or firing pin, passes through a hole in the face of the bolt head and discharges the cartridge in the firing chamber.

**Upward Action of the Bolt:** Turning the bolt handle up, the rear end of the bolt rib is turned away from the resistance shoulder and the resistance lug travels down in an inclined groove on the left hand side of the boltway. As the extractor is snapped over the head of the empty cartridge case firmly, this action twists and frees the empty cartridge case, to start the movement of extraction. It also pulls the entire bolt back about  $\frac{1}{8}$ ", while the cocking piece stud is forced from a cam groove up into a shorter cam groove and thereby withdraws the firing pin about an eighth of an inch.

As the bolt is pulled back to the rear, the extractor pulls the fired case to the rear until it strikes against the ejector and is thrown out the right side of the gun. Then the extractor spring snaps the extractor back into its place in the bolt head. As the bolt reaches its fully rear position, the zig-zag spring in the magazine pushes the magazine follower attached above it, directly up, bringing the next cartridge into line with the bolt.

As the bolt is thrust forward, it strikes the base of the cartridge in line and drives it ahead into the firing chamber. The full bent of the cocking piece comes against the sear nose stopping its forward travel. The striker being attached to the cocking piece, the main-spring is compressed between the striker collar and the rear wall of the bolt chamber. As this motion is completed, the bolt head still is about an  $\frac{1}{8}$ " away from full feeding.

When the bolt handle is turned down, the bolt head, being a separate piece attached to the bolt by screw tension, is held from rotating with the bolt. The bolt itself is turned by a hook on the bolt head extension, traveling along the body rib which snaps over the retaining spring. The rear of the bolt rib turns down over the resistance shoulder while the resistance lug on the bolt itself travels up the inclined groove on the left side of the bolt. These take the shock of discharge when the rifle is fired. Note that this differs

radically from the Mauser and Springfield in which the locking lugs are at the forward end of the bolt and turn into recesses in the receiver.

The long cam groove is now brought opposite the cocking piece stud. The short cam groove traveling upward is now able to receive the pin of the safety—the safety has been pulled back, securely locking the action as the bolt handle turns completely down. Meanwhile the upper limb of the sear is held upwards by the long limb of the sear spring whose short end rests against the magazine catch which it holds securely in place.

The magazine holds its 10-cartridges in two columns. The magazine follower is so formed that its left side is higher than its right. Thus as the cartridges are fed up, they come alternately from each column in the magazine, into line with the bolt. The sides of the rear end of the magazine extend slightly upwards and are turned in somewhat to retain the cartridges.

The magazine cutoff works in a slot below the rib on the receiver for the bolt head hook on the right side of the gun. When it is in the shut position, this cutoff holds the cartridges down below the line of the bolt travel, so that the magazine follower cannot rise to bring cartridges up in face of it. This keeps the magazine in reserve and permits single cartridges to be loaded directly into the firing chamber and lets the rifle be used as a single shot, while holding the magazine in reserve.

**Thumb Safety:** This is in the form of a rocker on the left side of the weapon. When it is fully forward, the rifle is ready to fire. When the thumb piece is rocked to the rear as far as it will go, the rifle is on "Safe." The locking pin on the safety catch then protrudes into the short cam slot in the rear of the bolt to prevent the bolt from rotating; while the half moon lug on the safety catch engages in a recess in the cocking piece preventing it from going either forward or rearward, while the safety is engaged.

**Special Note on the Enfield System:** The locking system on this rifle makes it the fastest operating bolt action rifle in the world. The abrupt turning action of the Mauser system will not permit it to attain a speed of operation possible with the Lee Enfield.

This rifle, since it has no locking recesses cut into the receiver, is much easier to clean than the Mauser type, and functions well under all battle conditions.

However, really accurate shooting at long ranges is not possible with this form of locking. It is noteworthy that the Sniper Rifles used by the British are developed from the Rifle No. 3 (American Enfield 1917 type).



# BRITISH ARMY RIFLES

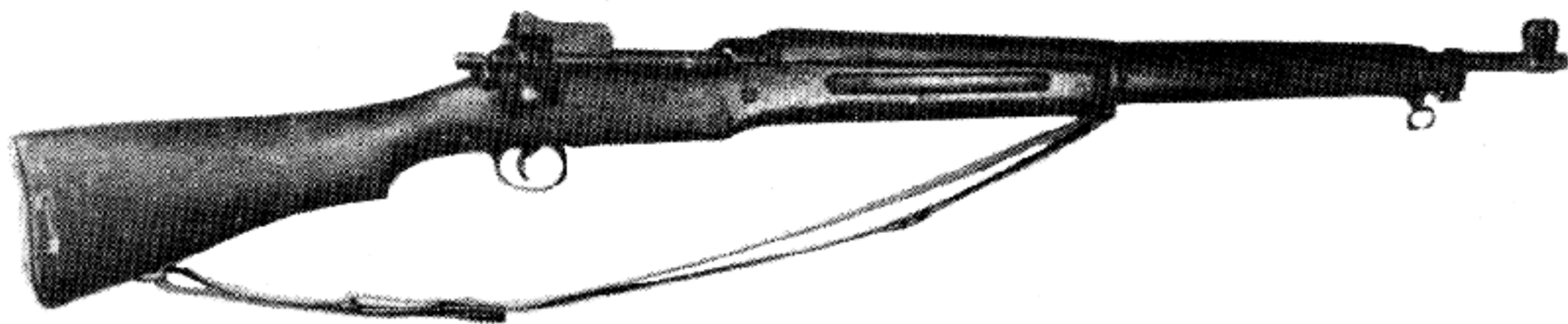

British Mark I\* Rifle 3

**.303—inch Pattern '14.**

**Caliber:** .303—inch British Service.

**Magazine:** Box type in receiver. Not removable. 5 shot capacity.

**Overall Length:** 3' 10½" (With bayonet about 5' 3").

**Weight:** 9 lbs. 6 ozs.

**Sights:** Aperture. Adjustable from 200 to 1650 yards. Aperture Battle Sight is set for 400 yards.

**Safety:** On right side of receiver just behind bolt handle. Rocked forward it is at the Fire position. Pulled back to the rear it is Safe and gun cannot be fired.

**Magazine Cut-Off:** None provided on this weapon.

**Bolt Release:** Mauser type on rear left end of receiver.

**Loading, Stripping and Functioning:** Same as for U. S. Rifle caliber .30, Model 1917.

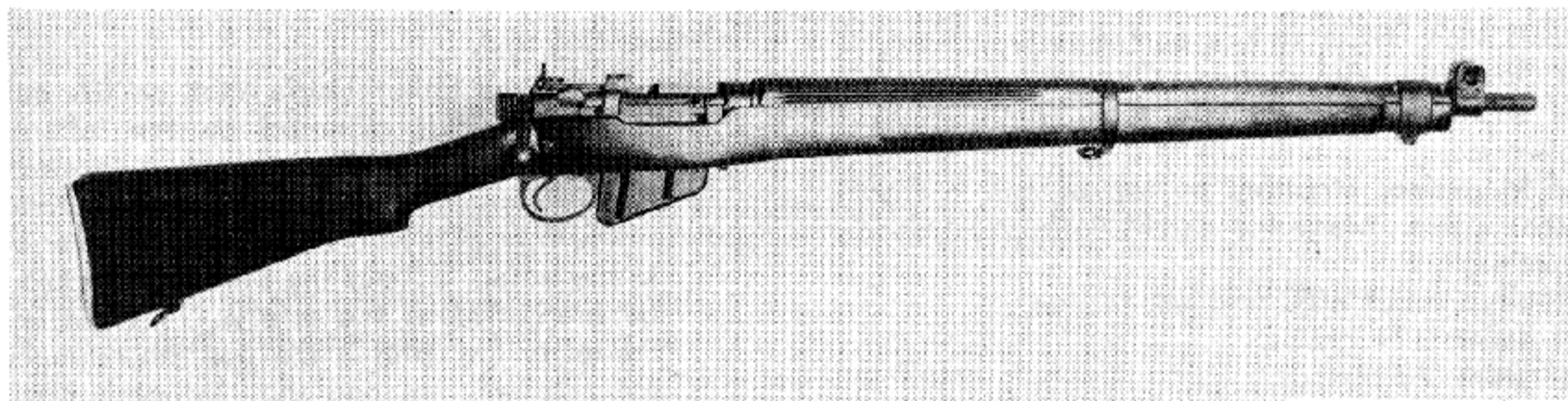

British Mark I Rifle 4

**Caliber:** .303 British.

**Magazine:** As for S.M.L.E. 10 shot—capacity, loaded with 2 clips of 5-rounds each.

**Overall Length:** 3' 8¾" (with bayonet 4' 5").

**Weight:** 9 lbs. 3 ozs. without bayonet. Bayonet weighs about 1 lb. less than that used on the Mark III\*.

**Sights:** Aperture rear. Blade front. Adjustable from 200 to 1300 yards, on pilot models originally issued. Adjustable 100 to 600 yards, on production models now generally issued.

**Safety:** Same as for Mark III.

**Cut-Off:** None provided on production model. Early issue has one similar to Mark III.

**Special Note on This Rifle:** This rifle was developed by British Ordnance after the first World War. It was designed for quantity production. Its similarity to earlier models may be grasped from the fact that it was originally called the Rifle No. 1 Mark VI.

It is fitted with a special spike-type bayonet (somewhat like the American Civil War type, about 8" long). The saving of a pound in weight in this type of bayonet is a considerable factor, particularly when the rifle is being fired with bayonet fixed.

This bayonet was also a factor in designing the sights for this rifle. In the production models of the rifle now being issued, there are two aperture sights set at right angles to one another. One is set for 300 yards with the bayonet fixed. When the bayonet is removed, this sight is accurate for 400 yards. The second aperture is

set for 600 yards, without bayonet.

Customary battle practice is to have bayonets fixed when enemy is within range of 300 yards or less.

The nose cap of this rifle is lighter than that in the Mark III. The barrel on the other hand is very much heavier, to give more stability.

The bolt head catch has been removed on this gun and its place taken by a small groove cut away in the bolt head runner in the receiver. The bolt is firmly secured and the bolt head cannot jump out of the receiver accidentally. It must be done deliberately, as the bolt head must line up with the cutaway.

Since there are two types of this rifle, one originally manufactured and issued for test, and the one now in general production, it is necessary to explain the methods of bolt removal:

(a) On first issue, lift the bolt handle and draw the bolt back part way. Push down the catch in front of the resistance shoulder and hold it there while the bolt is drawn back as far as it will go. Now releasing the catch and pushing up the bolt head will permit the bolt to be withdrawn.

(b) On second issue, lift the bolt handle up as far as it will go and draw it back about one-half inch. When the slot in the bolt head runner on the receiver is in line with the bolt head itself, the bolt head may be lifted to vertical position and the bolt withdrawn from the weapon.



# BRITISH BREN .303 LIGHT MACHINE GUN



**Caliber:** .303 Inch British service cartridge.

**Magazine:** Box type. Arc shaped. Capacity 30 rounds. There is also a 100 round drum type used for anti-aircraft work.

**Position of Magazine:** Mounted on top of gun in front of the rear sights. Magazine catch is directly behind the magazine.

**Muzzle Velocity:** About 2400 feet per second.

**Weight of Bullet:** 174 grains.

**Weight of Gun:** 23 pounds.

**Weight of 30 Round Magazine Loaded:** 2<sup>3</sup>/<sub>4</sub> pounds.

**Sights:** Fixed front. Aperture type rear. Rear sight adjustable on Mark I model from 200 to 2000 yards, 50-yard clicks; and 200 to 1800 yards in the Mark II model. Turning the range drum at the rear of the receiver on the left hand side elevates sight and shows a figure indicating the range.

**Accurate Range:** About 500 yards.

**Gun Operated by:** Gas escaping through hole in under side of barrel into gas cylinder and forcing piston to the rear to operate the mechanism and compress the return spring which supplies power for the forward motion of the action.

**Locked:** By rear end of breech block rising and locking into recesses in the top of the receiver.

**Cooled:** Air cooled. Action remains open between shots. Bolt stays back permitting circulation of air through ejection port and barrel.

**Cyclic Rate of Fire:** 450 to 550 rounds per minute.

**Position of Cocking Handle:** On right hand side of receiver. It is drawn straight back to cock the weapon, then pushed forward so that the action will not have to carry it forward, and in the Mark I type it is then folded against the receiver. In the Mark II model it

does not fold.

**Type of Fire:** Either single shot or full automatic. A change lever is mounted on the left side directly above the trigger. Push this lever forward to the letter "A" and the weapon will fire full automatic as long as the trigger is held back. Set the lever in the center at the letter "S" and the weapon is locked and cannot be fired. This is the safety. Turn the lever back to the letter "R" (this is the position normally used) and the rifle will fire one shot for each pressure of the trigger. "R" stands for repetition or rounds, the British designation for single shot fire.

**Flash Hider:** As in the Browning automatic rifle, a sleeve extending forward beyond the muzzle of the barrel hides the flash of powder burning after it leaves the muzzle of the barrel.

**Tripod:** A tripod weighing 30 lbs., and having an elevation limit of 19° with a traverse of 42° is sometimes furnished with this weapon to convert it to a medium machine gun instead of light machine gun.

**AA Mounting:** The tripod is issued with a special device to be attached to the tripod, which permits it to be quickly converted into an anti-aircraft mount. Used in the tripod mount, the gun is locked at front below gas cylinder and at rear below butt; while in the AA mounting, it is fastened in the front end on a mounting pivot, giving complete flexibility to the gunner.

**Ejection:** This weapon ejects through the bottom.

**Note:** This gun is normally fired by one man using a bipod mount. A pistol grip is provided for the right hand, the butt held against shoulder with the strap resting on top of the shoulder, the left hand gripping a folding butt handle extending down below the butt.



# BRITISH BREN .303 LIGHT MACHINE GUN

## LOADING AND FIRING

To load the magazine by hand: The magazine is rested on the thigh, or on a solid object, and cartridges placed in the magazine as for ordinary automatic pistol. They should be inserted with the right hand, and pressed down into place with the thumb of the left hand. Unlike our United States cartridge, the British service cartridge has a rim. In inserting cartridges in magazine, therefore, care must be taken to see that the rim of each cartridge is placed **in front of the round already in the magazine**. If rim get behind rim, jams will inevitably result.

**Magazine Filler:** Push the magazine into the mouth of the filler, and swing the filling lever as far as it will go to the left. Fill the hopper and push the filling lever over

to the right and back to its limit 6 times; this will put 30 rounds into the magazine. If the filler is the small hand type, push magazine in until the magazine catch engages, and then insert a loaded cartridge charger (or clip as it is called in the United States) into the mouth of the filler over the head of the magazine. See that the tip of the operating lever is against the topmost cartridge and push down slowly and firmly with the operating lever.

**Note:** While the magazine capacity is 30, it is better practice to use 27 or 28 cartridges so as not to strain the magazine spring.

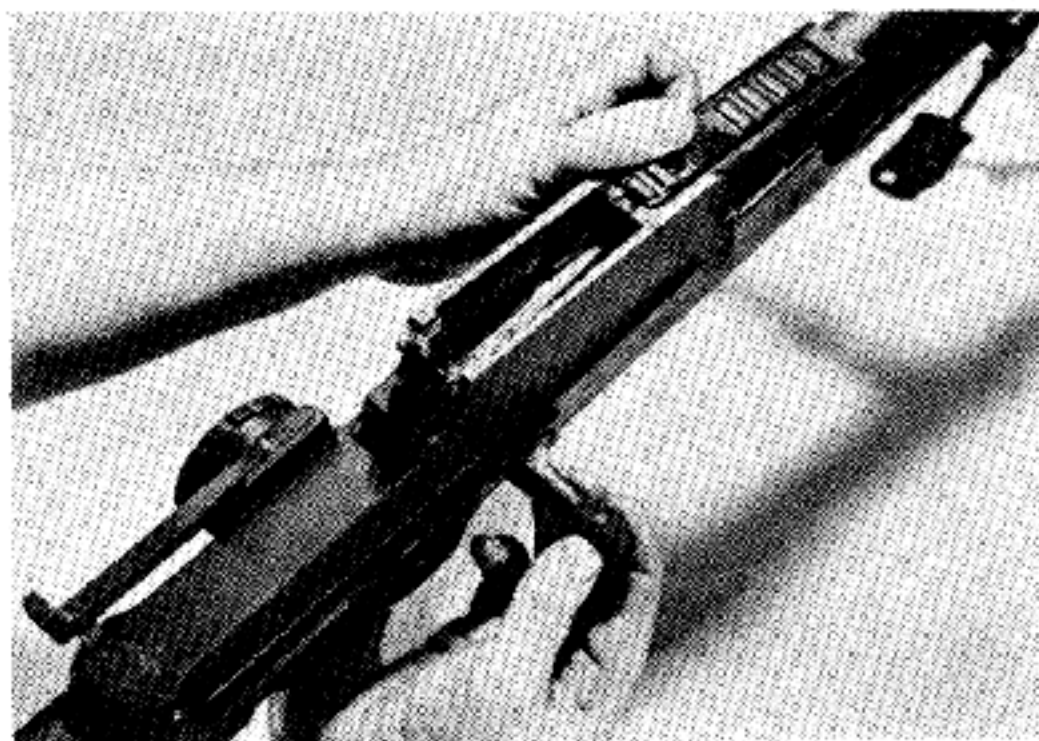

The magazine opening on top of the receiver is fitted with a sliding cover; push this opening cover forward as far as it will go.

Holding the magazine mouth downward in the right hand, insert the lip **at the front end into the magazine opening** and hook it there; then press downward the rear of the magazine until the magazine catch engages on the magazine rim.

Draw the cocking handle back as far as it will go to cock the action and push it forward again. If weapon has a folding cocking handle, fold it over.

Set the change lever on the left side of the receiver

at the desired position of "Automatic," "Safe," or "R" for single shot.

**Note:** A cover over the ejection opening will automatically spring open when the trigger is pulled to permit ejection of empty cartridge case.

**Caution:** Always remember that this gun fires from an **open bolt**. The bolt should never be permitted to go forward while there is a magazine in the gun unless you intend it to fire. The magazine must be removed first, and the action eased forward second in unloading the weapon.

## FIELD STRIPPING



Be sure there is no magazine in the gun and all moving parts are forward.

The body locking pin passes through the receiver from right to left directly under the aperture of the rear sight. Push it with the point of a bullet from the **left** side and withdraw it from the **right**.

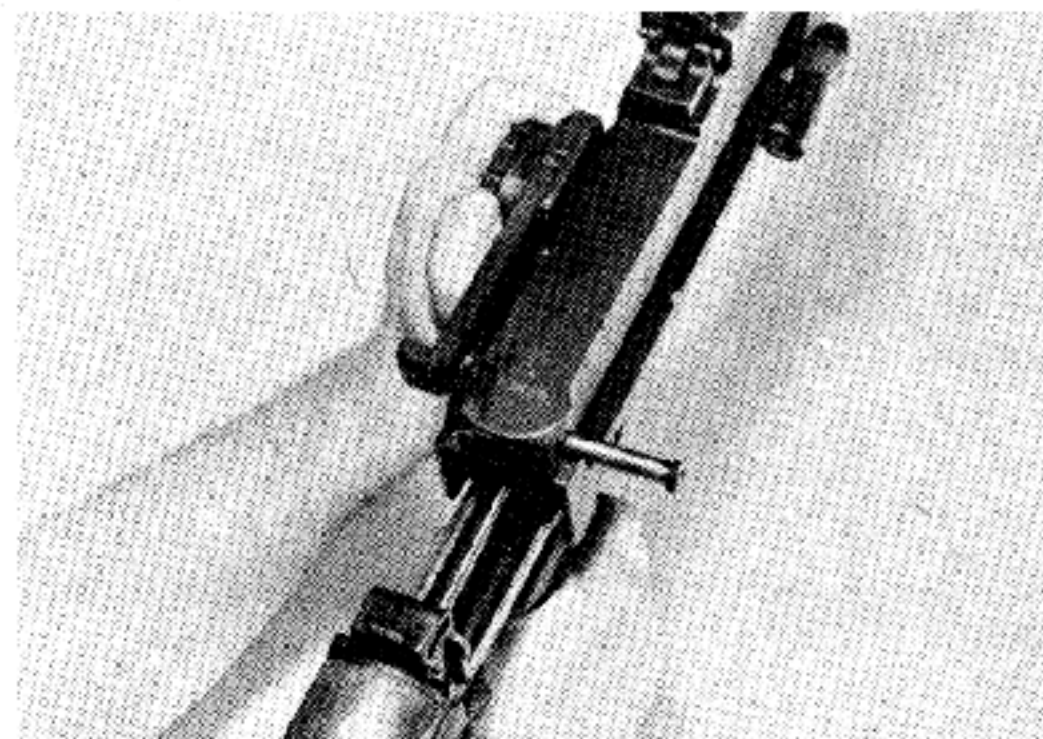

Grasp the back sight drum firmly with the left hand, and with the right pull back the butt group as far as possible. The return spring rod, which is housed in the butt, will now protrude from the butt through the buffer.



# BRITISH BREN .303 LIGHT MACHINE GUN

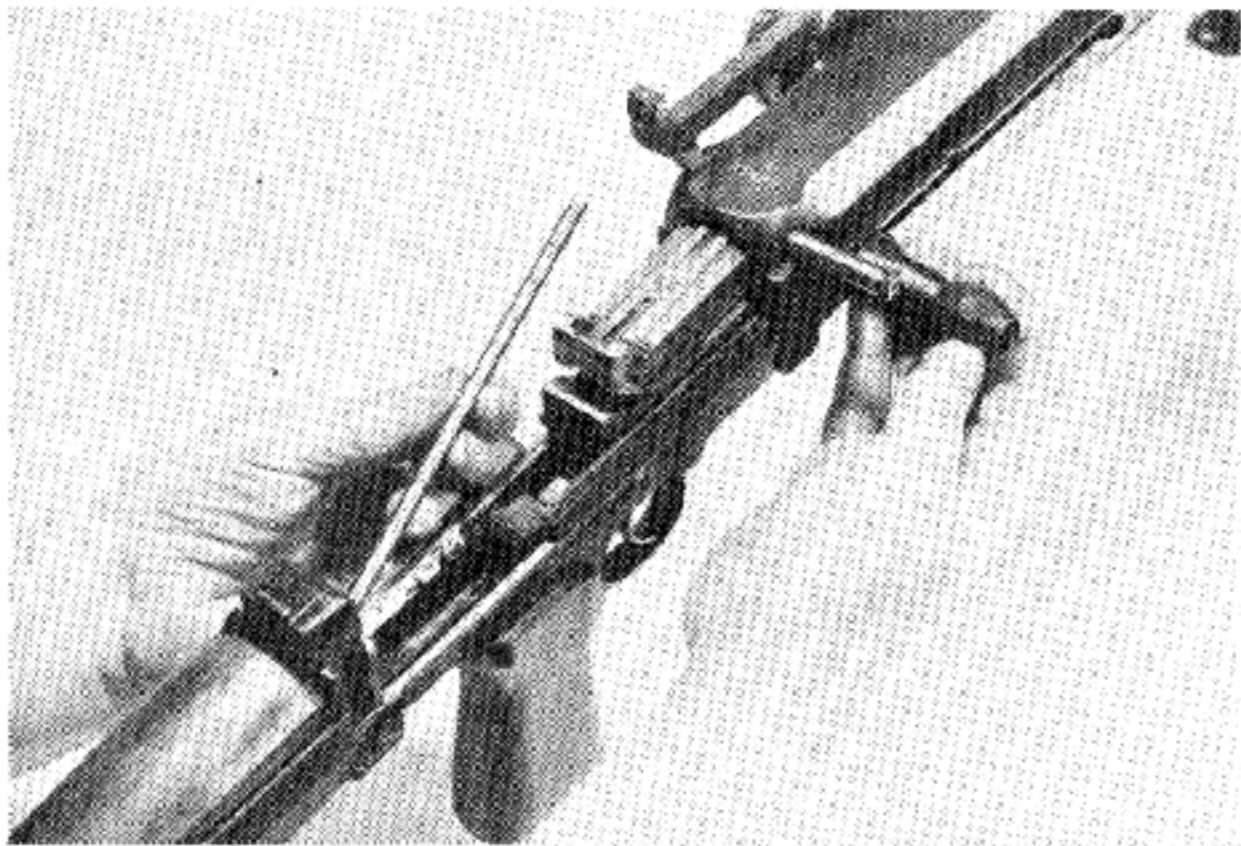

With the thumb and forefinger of the left hand pull the return spring rod to the left out of line with the piston; and with the right hand pull the cocking handle

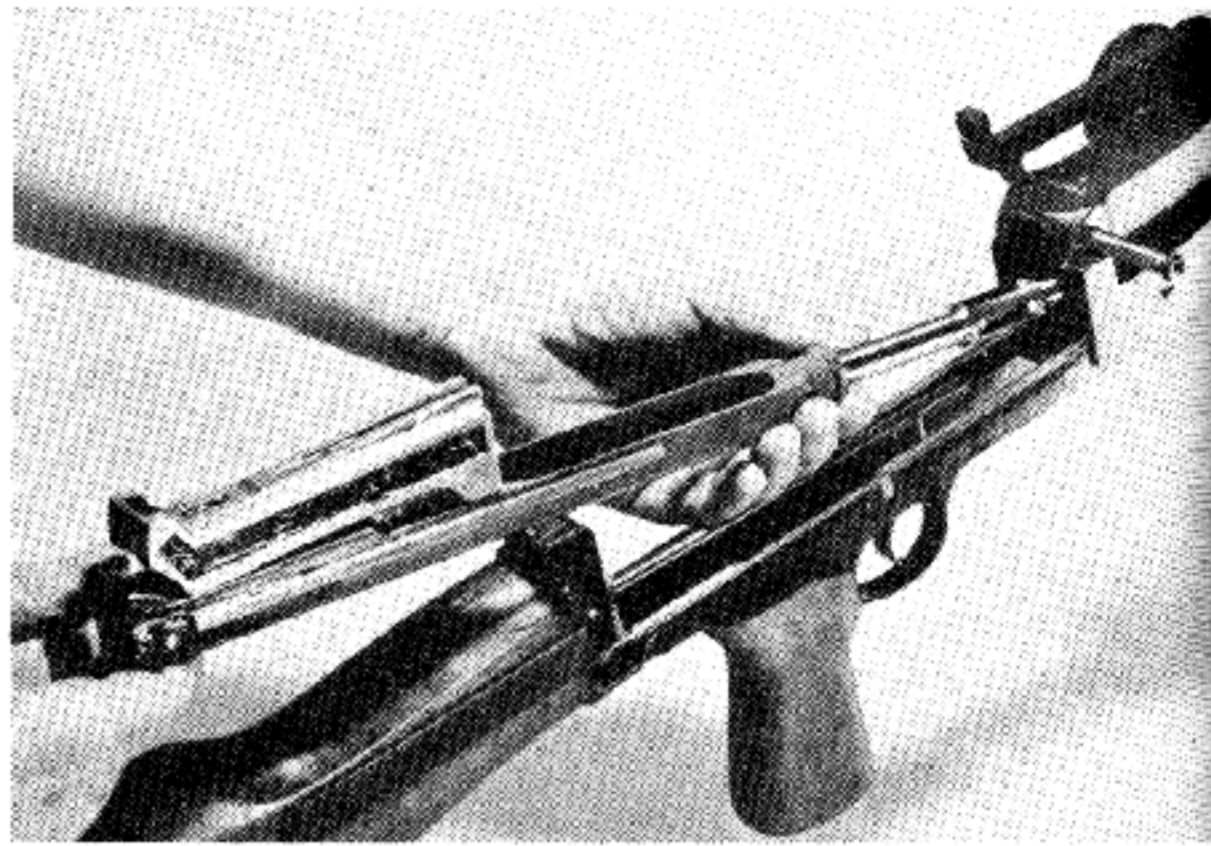

back with a rapid motion. The piston and breech block will now come out of the receiver and may be removed from the gun.

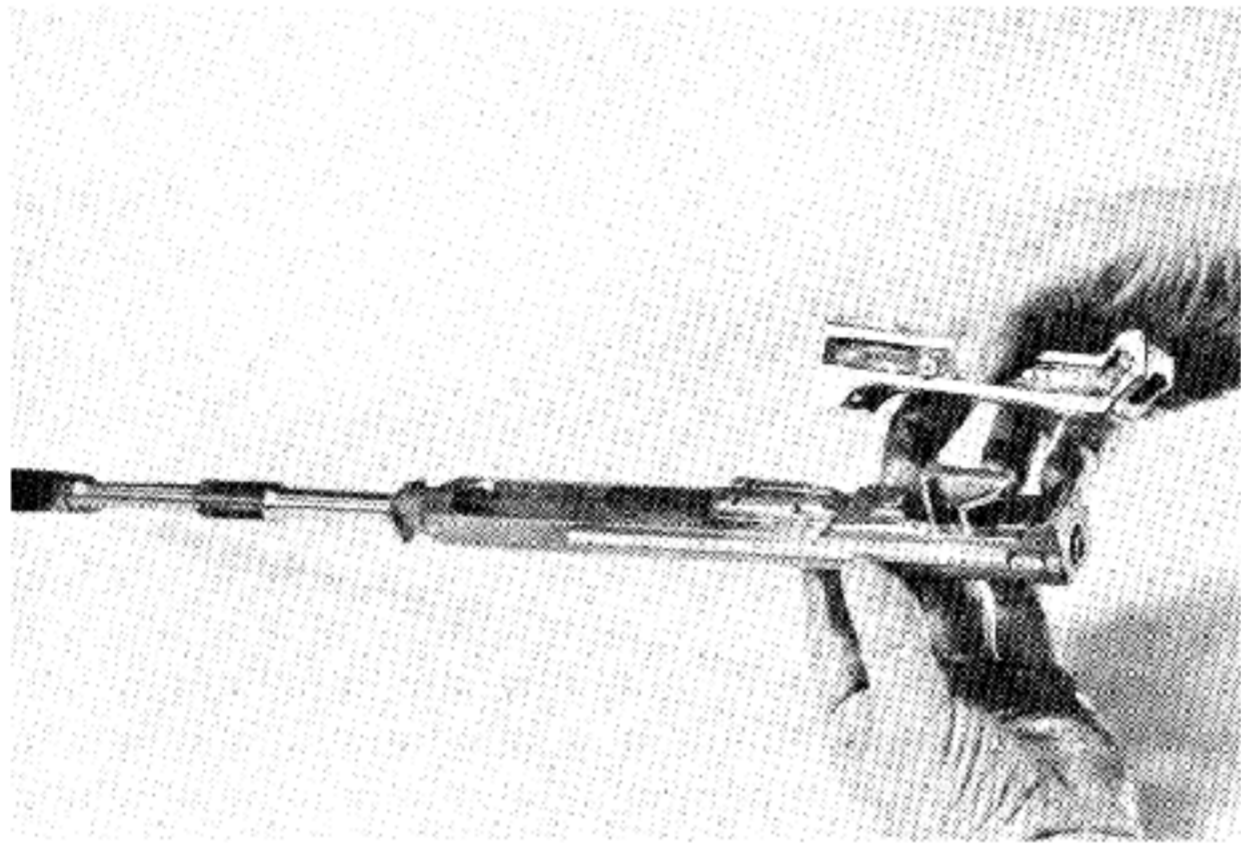

The claws at the front end of the breech block are in engagement with grooves on the piston, and if the breech block is slid to the rear it can be lifted out of this engagement and removed.

The barrel nut catch lies on the side of the barrel just ahead of the magazine opening. Force in the spring

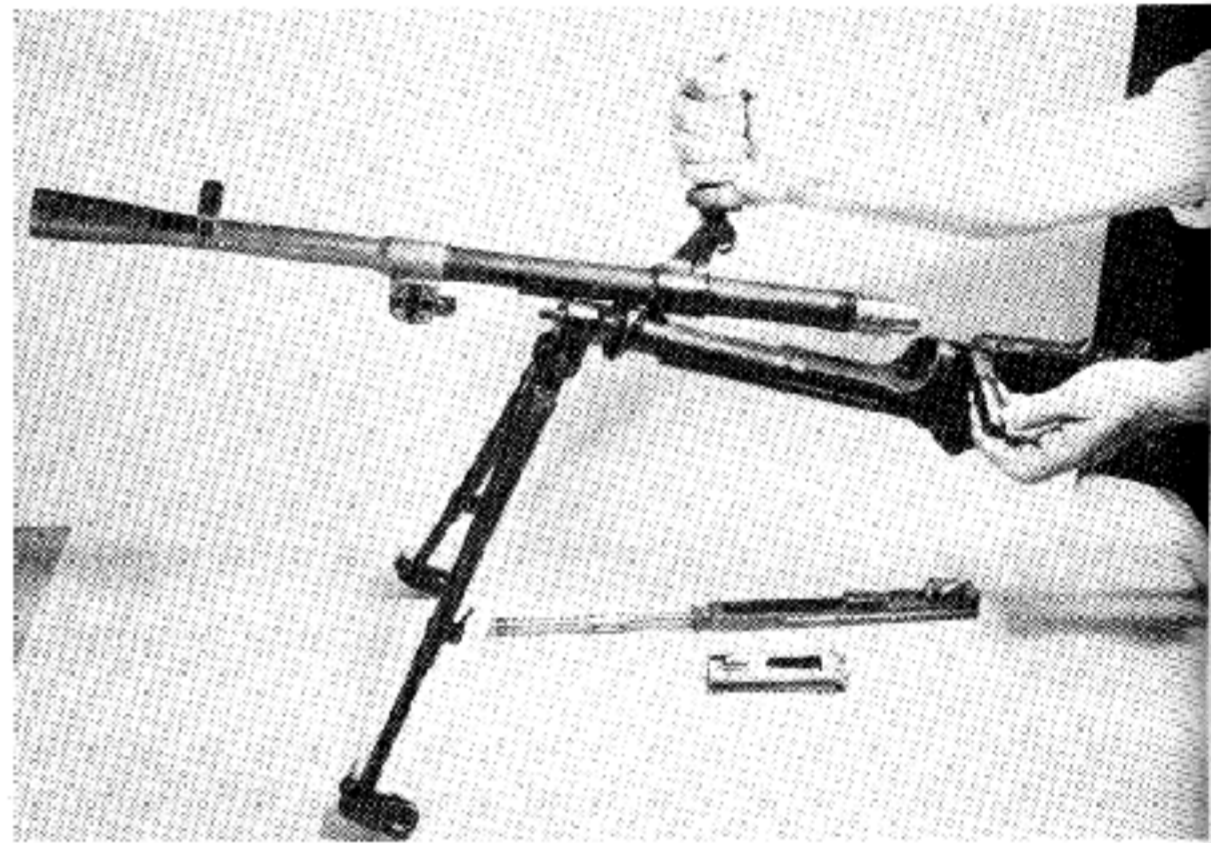

catch on its underside and lift the barrel nut catch as far as it will go; which will free the barrel for removal.

Holding the wooden carrying handle with the right hand, push forward on the barrel while holding firmly to the back sight drum with left hand. The barrel will now come forward and may be lifted out.

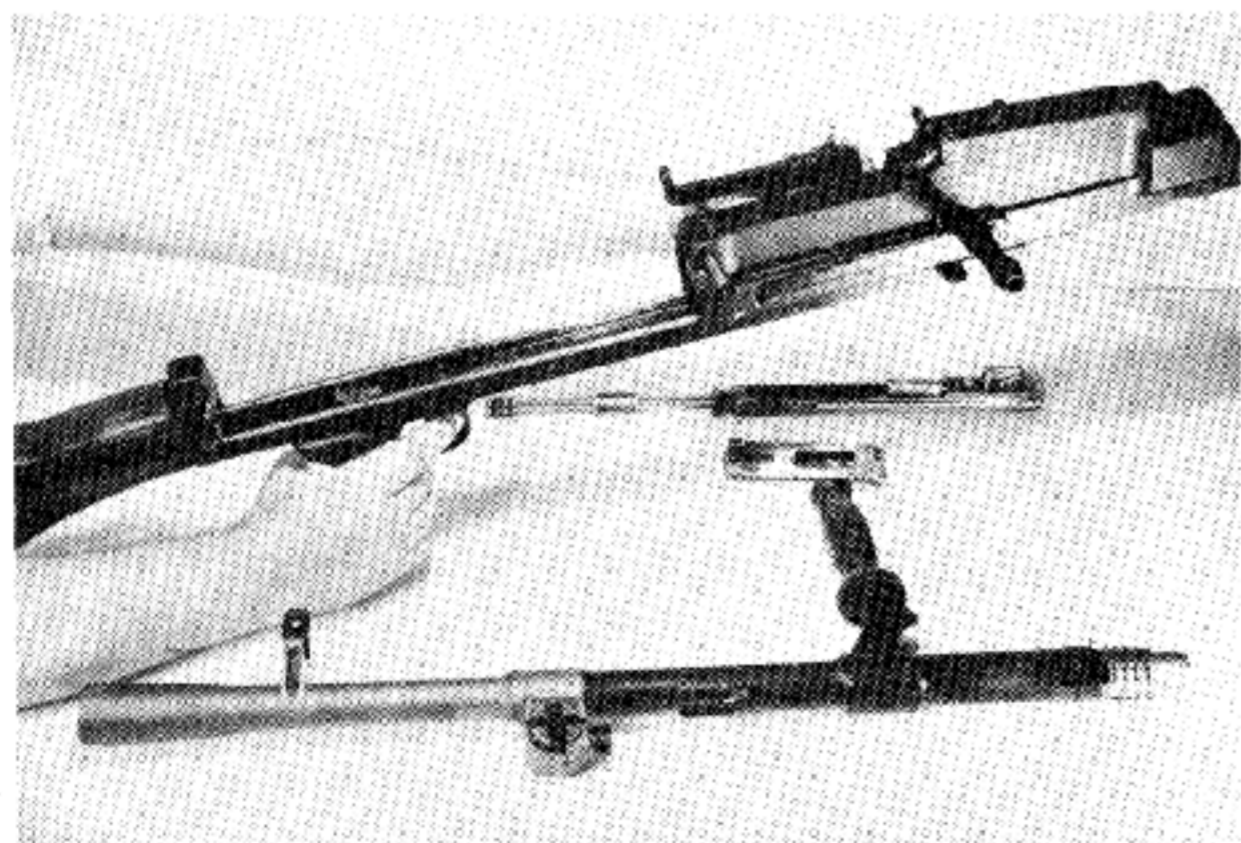

Grasp the rear sight drum firmly with the left hand and with the right hand pull directly back on the butt. The entire butt group may now be removed.

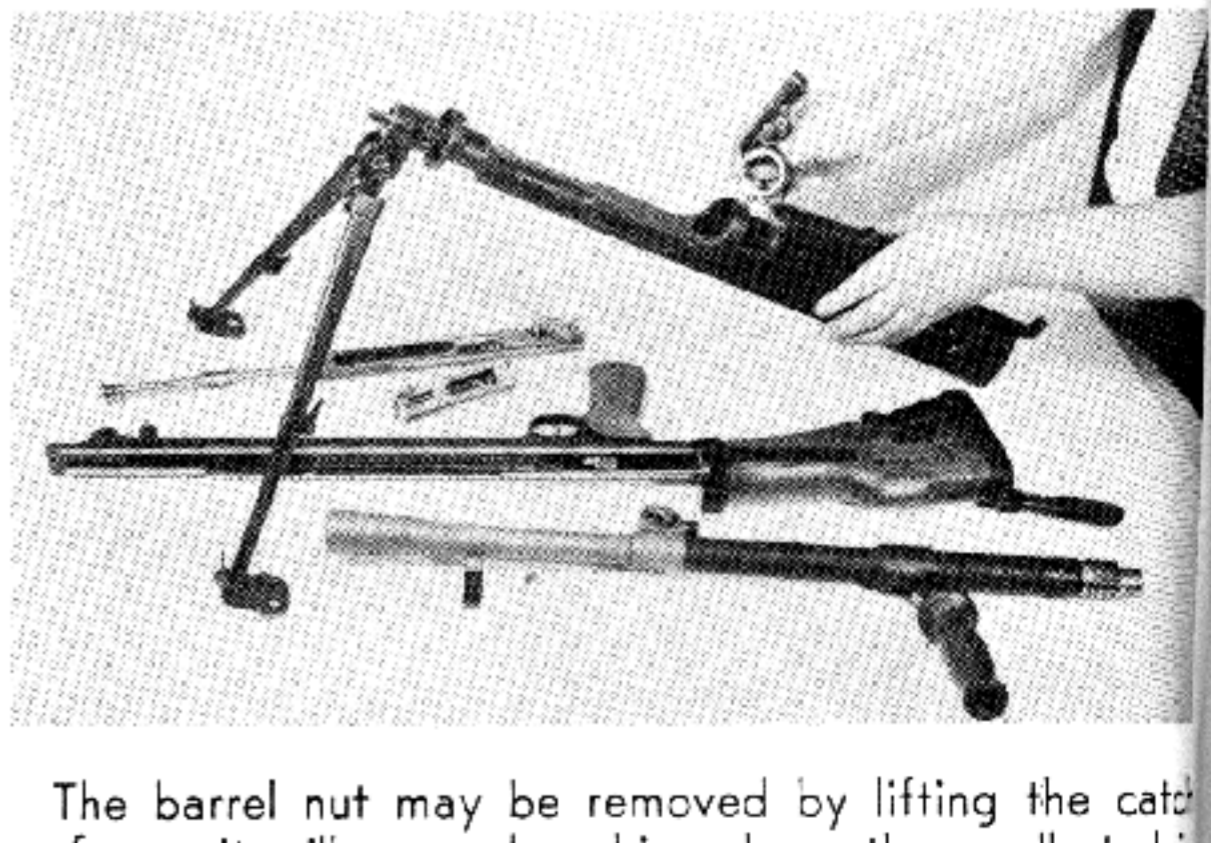

The barrel nut may be removed by lifting the catch as far as it will go and pushing down the small stud in front of the magazine opening cover. The barrel nut is then lifted out vertically.

Now lift the front of the body with the right hand and with the left pull the left leg of the bipod as far forward as possible—slide bipod sleeve off the front end of the gas cylinder.



# BRITISH BREN .303 LIGHT MACHINE GUN

## NOTES ON ASSEMBLING

Reverse the stripping order.

In replacing bipod take care the mount is fully home.

In Mark I guns check that the stop on the left of the forward end of the butt group is in front of the barrel nut catch before lowering the catch.

In replacing barrel on Mark I, make sure the long groove underneath between gas block and carrying handle engages properly with stud on top of receiver.

Be sure the barrel nut catch is fully locked and catch has engaged on rib in the body or receiver.

When replacing breech block on piston, slide the claws down into the groove as far forward as possible and then let the tail of the breech block drop.

When inserting the assembled breech block and piston, make sure that the breech block is fully forward and that the two are pushed right into the receiver before attempting to push forward the butt group.

Be sure that the return spring rod engages in a recess for it in the end of the piston when the butt group is being pushed forward.

## GAS REGULATOR

The gas regulator is mounted on the barrel near the fore end of it. It faces to the left. The correct setting is usually the No. 2 size. There are four different ports. Lifting the retainer pin permits the gas regulator to be

turned to increase the size of the port. Should the gun become sluggish in action, the gas regulator is altered to the next largest hole to increase the amount of pressure available.

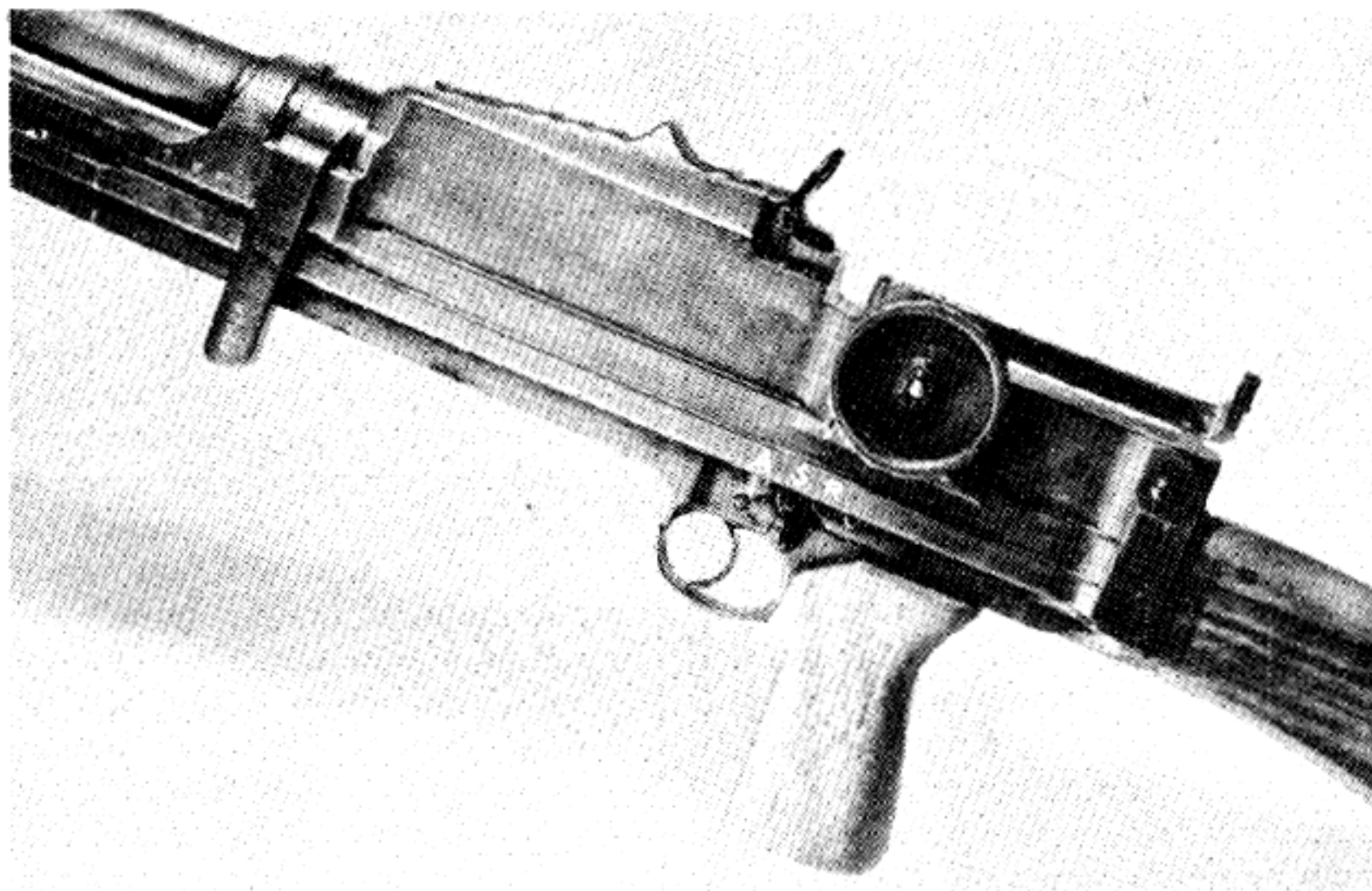

Showing Change Lever for Safe, Automatic, or Single Shot Fire

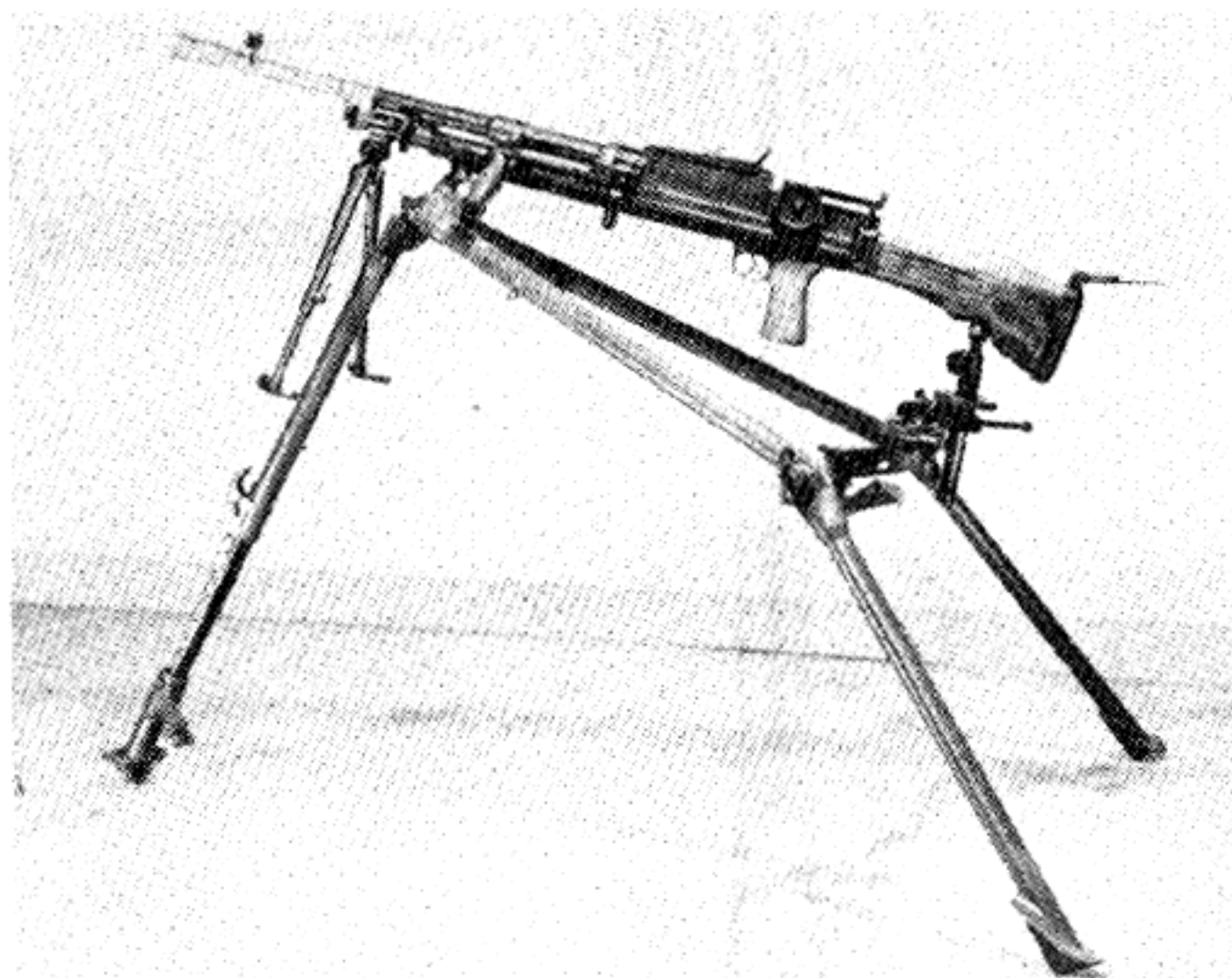

Showing Details of Tripod Mount



# BRITISH BREN .303 LIGHT MACHINE GUN

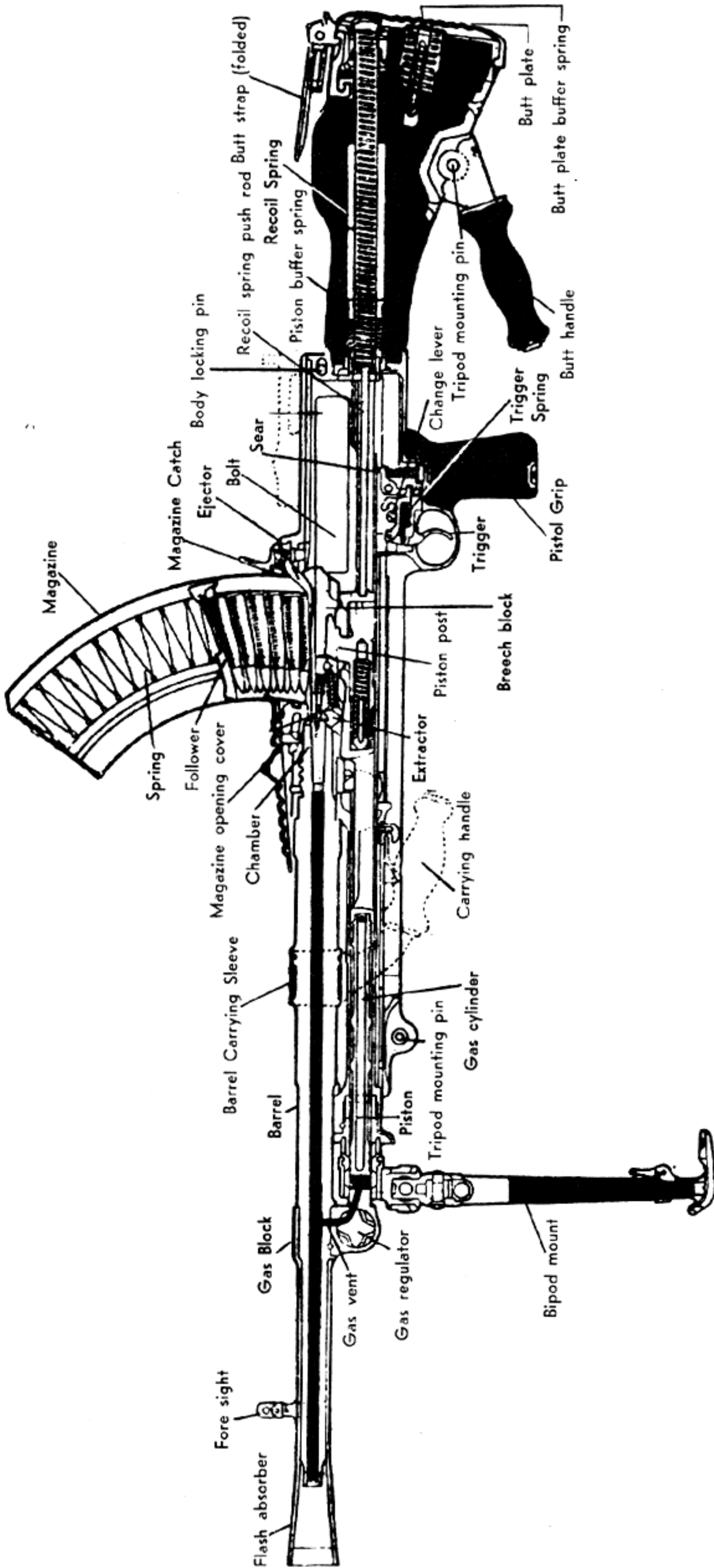



# BRITISH BREN .303 LIGHT MACHINE GUN

## HOW THE BREN GUN WORKS

Starting with the gun loaded and cocked, the action is as follows: If the change lever is set at "R," pressing the trigger pulls a connecting tripping lever, which in its turn draws down the sear out of engagement with the pin on the piston. This action also compresses the coil sear spring. The compressed return spring, situated in the butt, pushes the rod forward, and this in turn pushes against the seat in the piston driving the piston forward, carrying with it the locking and firing mechanism. Meanwhile the sear spring pushes the sear back into place. The breech block mounted on the top of the piston is carried forward, and the feed piece strikes the base of the first round in the magazine and forces it forward out of lips of the magazine and into the chamber, with the extractor slipping over the rim. The rear end of the breech block is cammed up into a locking recess in the top of the receiver as the cartridge is properly chambered; and in its final move the piston post drives the firing pin against the primer of the cartridge exploding it.

As the bullet passes over the small gas vent cut in the barrel, a short distance from the muzzle, a small amount

of gas under high pressure passes through the vent and through the gas regulator (where the size of the port selected determines the amount of gas to be let in) and escapes into a well where it expands with a hammerlike thrust against the piston. As the piston is driven back in its cylinder, the gas can now escape through holes provided for it.

Meanwhile the sudden thrust on the piston drives it back and forces the return spring rod back into the butt where the return spring is compressed; this action being finally stopped by the piston buffer.

The empty cartridge case gripped by the extractor and carried to the rear on the face of the breech block, strikes its face against the base of the ejector and is hurled downward through the ejection slot in the piston and out of the weapon. During this rearward action the upper locking surfaces of the breech block are forced down into line, so that in its final movement, the piston and breech block travel together in a straight line.

**Note:** The buffer spring is in the butt below the line of the return spring.

## SPECIAL NOTE ON THE BREN GUN

This is one of the finest light machine guns ever developed. Originally manufactured in Brno, Czechoslovakia, it was further engineered and developed in England and gets its name from the combination of Brno and Enfield. As mentioned before, while this weapon is essentially a one-man machine gun intended to be used from a bipod mount, or fired from the hip while moving in action, it may speedily be converted into a heavy machine gun firing from a solid tripod mount, or a very effective antiaircraft machine gun against low flying planes. The normal rate of automatic use is 5 bursts of 4 or 5 rounds each, averaging about one magazine a minute. In emergencies, it may be fired at the rate of 4 magazines a minute. A very fast operator can deliver 150 shots or 5 magazines in a minute. For all general purposes, however, it is intended to be fired one shot

for each pull of the trigger, as an automatic rifle. This procedure saves ammunition and conceals from the enemy the fact that a machine gun is in operation against them.

A spare barrel is issued with each gun and the ease and rapidity of barrel change is a very important feature of the weapon. As the magazine is mounted on top of the receiver, the sights have to be set off to the side of the barrel so that the line of sight will not be interfered with.

The Japanese are making very extensive use of Bren guns captured in the Far East from the British. The Chinese are producing Bren guns manufactured in crude Chinese factories. Bren guns made in captured Czech factories are being used by the Germans in caliber 7.92mm.



# BRITISH LEWIS .30-06 LIGHT MACHINE GUN

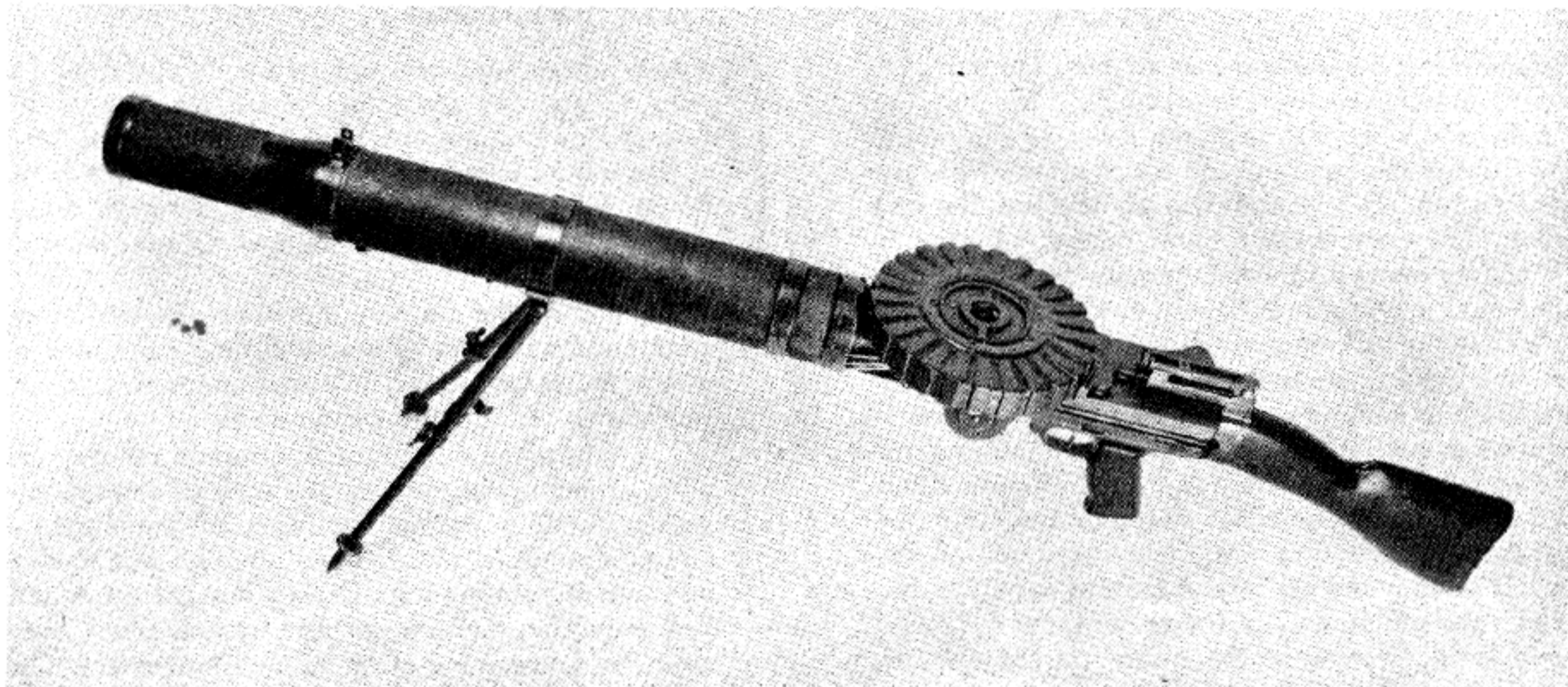

This weapon, although invented by a U. S. Army officer, was originally adopted by the British Army for their rim type cartridge, caliber .303. It was later altered and somewhat improved to handle the standard U. S. Government .30-06 cartridge, which is rimless. Differences between the two models are comparatively minor, and will be pointed out where essential in the course of the following presentation.

**Weight of Standard Ground Type:** 25 $\frac{1}{4}$  to 28 lbs., complete.

**Caliber:** .30-06 or M1 if United States Model.

**Caliber:** .303 British if British model.

**Magazine:** Rotating pan type, holding 47 cartridges in spirals.

**Muzzle Velocities of Cartridges:** Standard for cartridges employed.

**Weights of Bullet:** Standard service cartridge weight.

**Barrel Length:** 26 $\frac{1}{4}$ ".

**Overall Length of Gun:** 50 $\frac{1}{2}$ ".

**Weight of Loaded Magazine:** 4 $\frac{1}{8}$  lbs.

**Gun Operated by:** Gas escaping through small port in underside of barrel into gas chamber where it forces back head of piston and drives it back to eject empty

cartridge and wind mainspring to provide driving power for forward movement of action.

**Cooled:** Aluminum radiator and radiator casing surround the barrel. When firing, cool air is sucked from the rear through fins in the open casing around the barrel to help dissipate heat.

**Sights:** Fixed front, aperture rear, graduated to 2000 yards.

**Cyclic Rate of Fire:** 500 to 600 rounds per minute.

**Locked:** By rotating bolt. It is provided with 4 resistance lugs which lock into corresponding slots in the receiver during the period of high pressure in the barrel. These lugs are revolved out of their slots as the piston travels backwards.

**Type of Fire:** Full automatic only. No selector device is provided.

**Position of Charging Handle:** (Called cocking handle in Great Britain.) Normally on the right side of the receiver. However, on U. S. Airplane type Lewis guns, which have a spade grip and no radiator barrel casings, the cocking handle may be on the left side. On certain types of Lewis guns this handle may be inserted on right or left side.

**Safety:** On U. S. Models, a long narrow sliding strip of steel is fitted on the receiver, directly below the charging handle slot. When the charging handle is to the rear, meaning the weapon is cocked, a thumb piece on this strip may be pushed, which will force the strip up and let the slot engage with the shank of the charging handle so it cannot go forward. This also disengages the trigger mechanism. Pulling back slightly on the charging handle and pushing down on the thumb piece removes the safety.

**Warning:** Remember that this gun fires from an open bolt. When there is a magazine in place, if the bolt goes forward it will fire a cartridge. This bolt cannot be lowered while the magazine is in place. Except when ready for firing, the cocking handle should **always** be in the forward position.

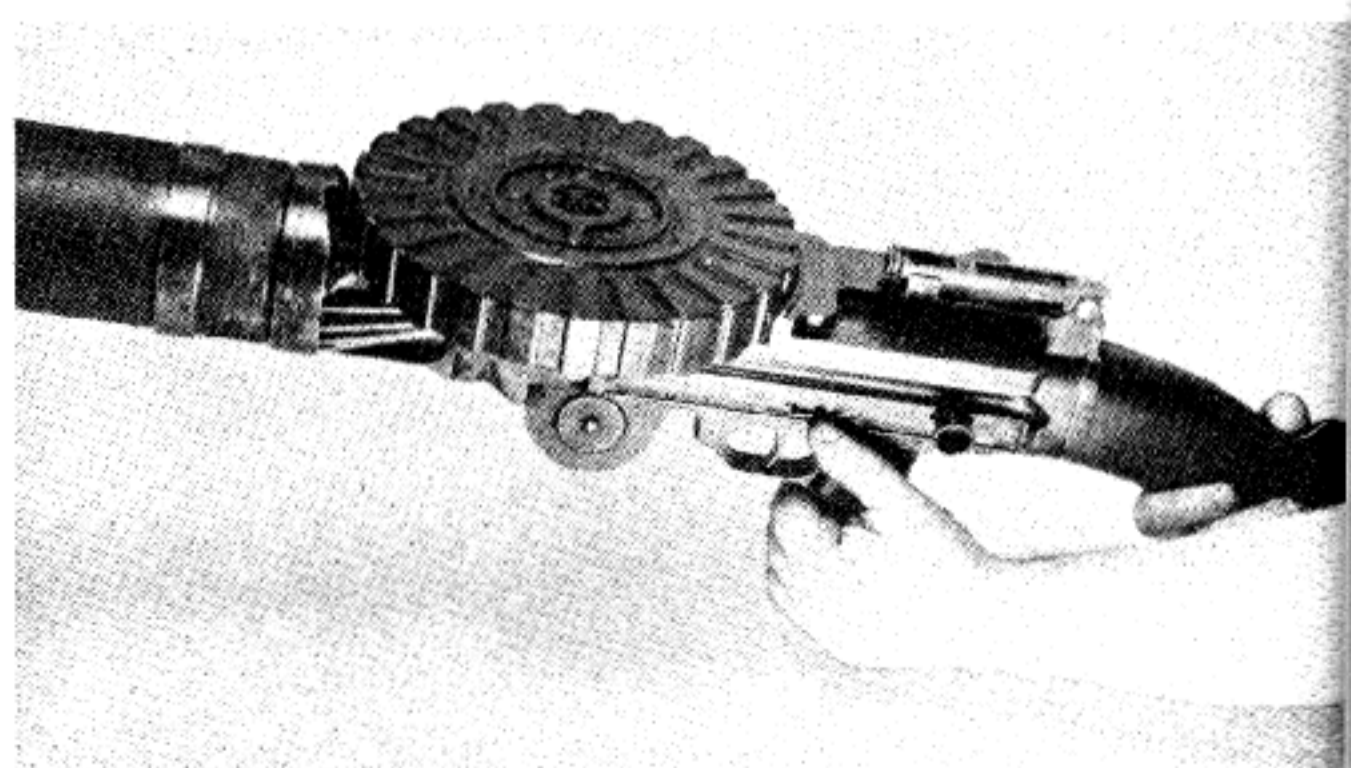



# BRITISH LEWIS .30-06 LIGHT MACHINE GUN

## LOADING AND FIRING THE LEWIS GUN

Put handle on magazine filler in the magazine socket to release the magazine catch and permit the center block to rotate.

Insert cartridges in magazine filler, rim towards outside of pan, bullets toward center.

Turn the handle on the filler from right to left to feed cartridges into the magazine; and be sure that the groove in the base of each cartridge engages in the retaining plate inside the magazine.

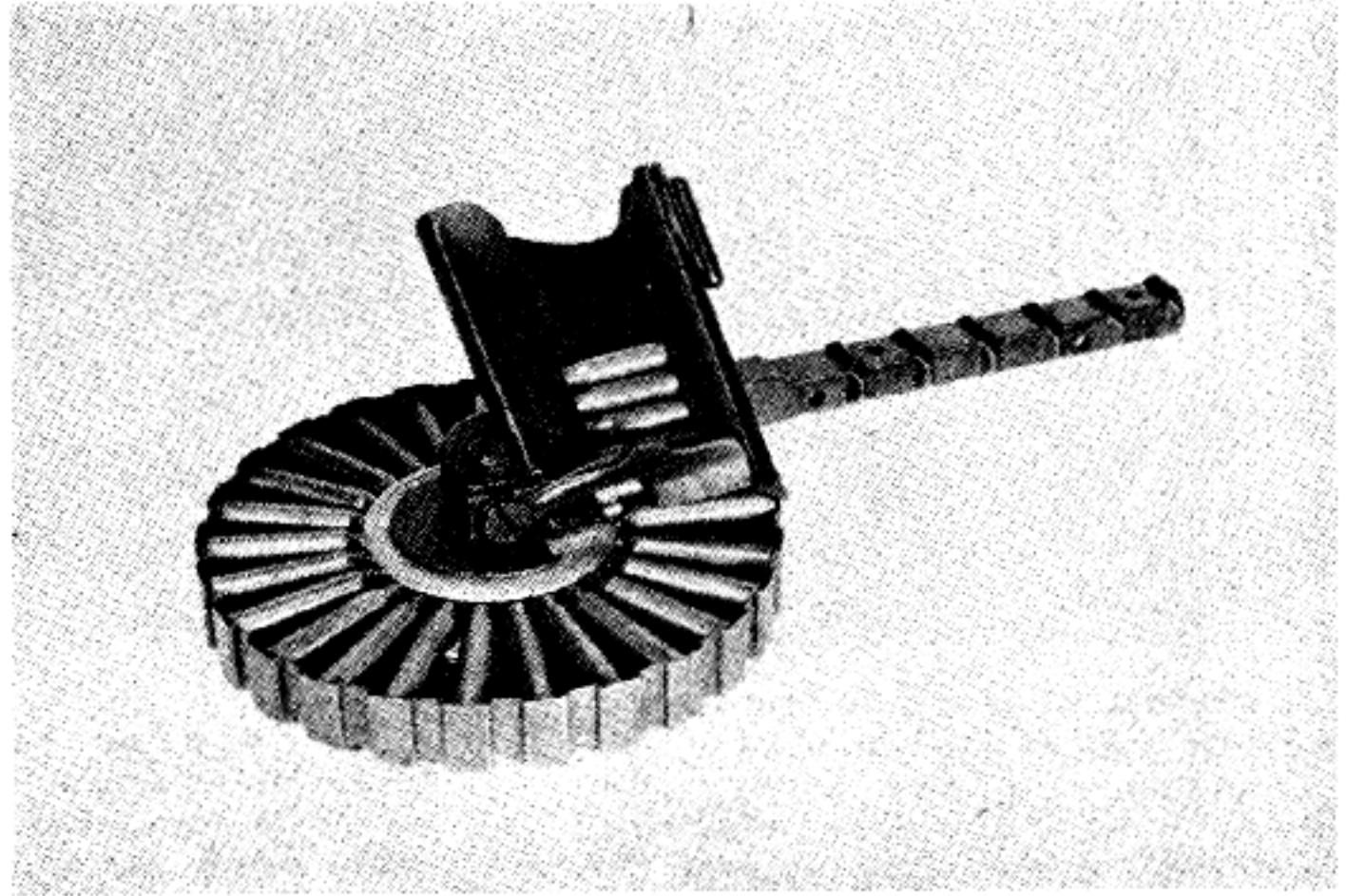

If no filler is available, hold magazine with left hand, inserting a finger from below to depress the magazine catch, which must be released to permit rotation, and insert cartridges singly, starting the bullet in the magazine center and revolving slowly so that the cartridges take their proper places between the separators.

Put a loaded magazine into place over the magazine post and press down until the catch engages. The catch should face to the right. Rotate the pan slightly in both directions until the hook of the catch locks inside its recess in the magazine.

Now rotate the magazine from left to right until resistance is encountered.

Draw back the charging handle as far as it will go and release it. It will be held in place waiting a pull of the trigger.

**Warning:** The weapon will now fire when the bolt moves forward.

**Special Note on Unloading Lewis Gun:** With most machine guns, removing loaded cartridges safely is simply a matter of removing the magazine; or in the belt type, working the operating mechanism back by hand once or twice. However, the feed construction of the Lewis gun is such that it is not feasible to use the ordinary procedure.

**For U. S. Caliber .30:** Press in magazine release stud and pull magazine off the post. **There will still be a cartridge in the feedway.**

Grasp the charging handle firmly with the left hand and pressing the trigger with the right to release the moving parts, ease them forward very slowly until the cartridge in the feedway clears the feed arm and drops into the boltway. At that point, pull back the charging

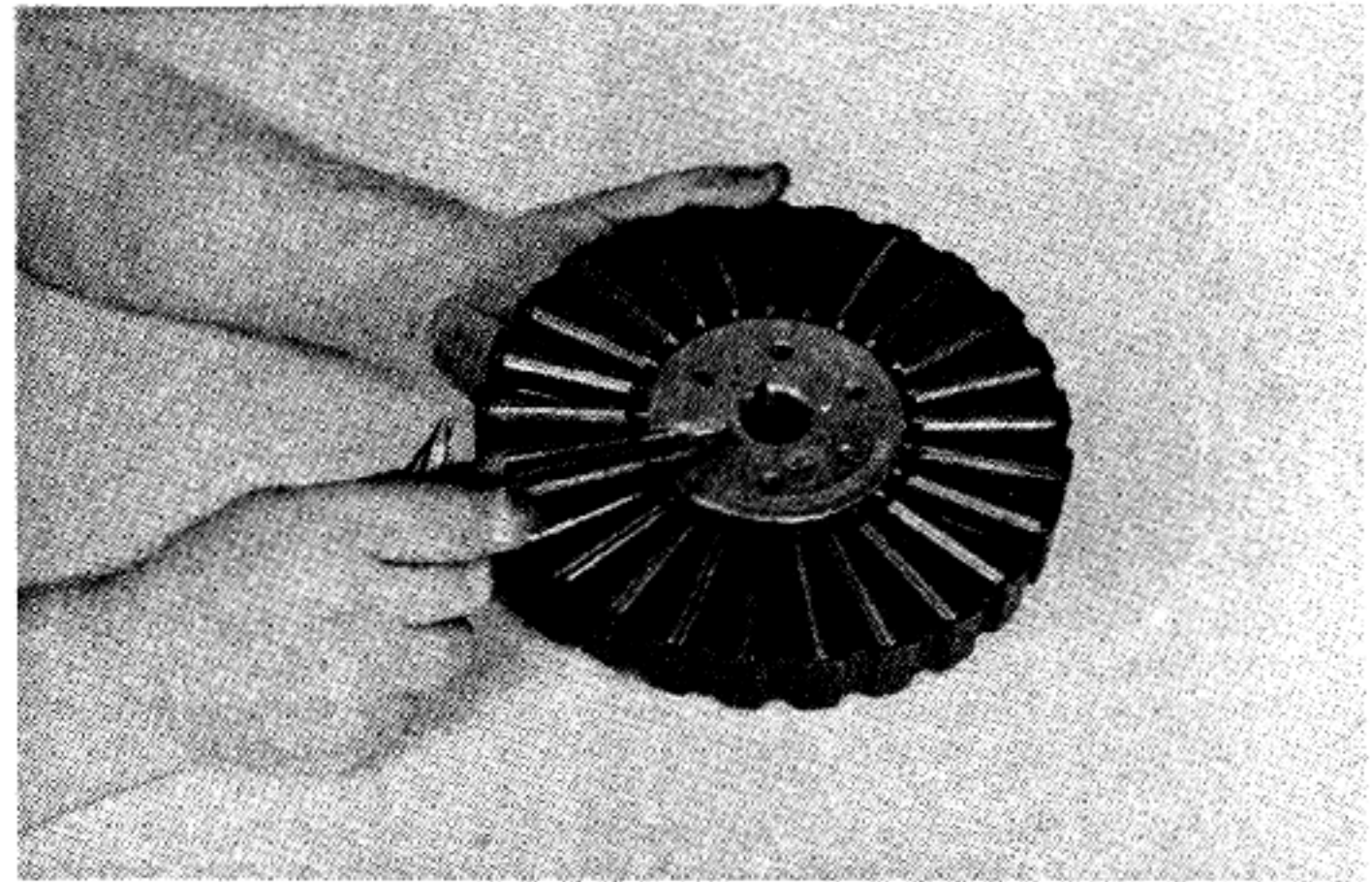

handle and push up the safety catch to lock it into place. Then turn the gun over on its right side and shake the cartridge out. The action may now be safely permitted to go forward.

**British .303:** Push in magazine catch with thumb and remove magazine from post. Use cartridge or screw driver to press against the base of the round held by the feed arm so that the bullet end will rise. Pull the cartridge forward as far as possible. Holding the cocking handle securely, press the trigger to release it and work cocking handle slowly forward and back until the cartridge falls clear or can be pulled out. (Take care not to let the action go forward far enough to chamber the cartridge, as that would fire it.)



# BRITISH LEWIS .30-06 LIGHT MACHINE GUN

## FIELD STRIPPING THE LEWIS GUN

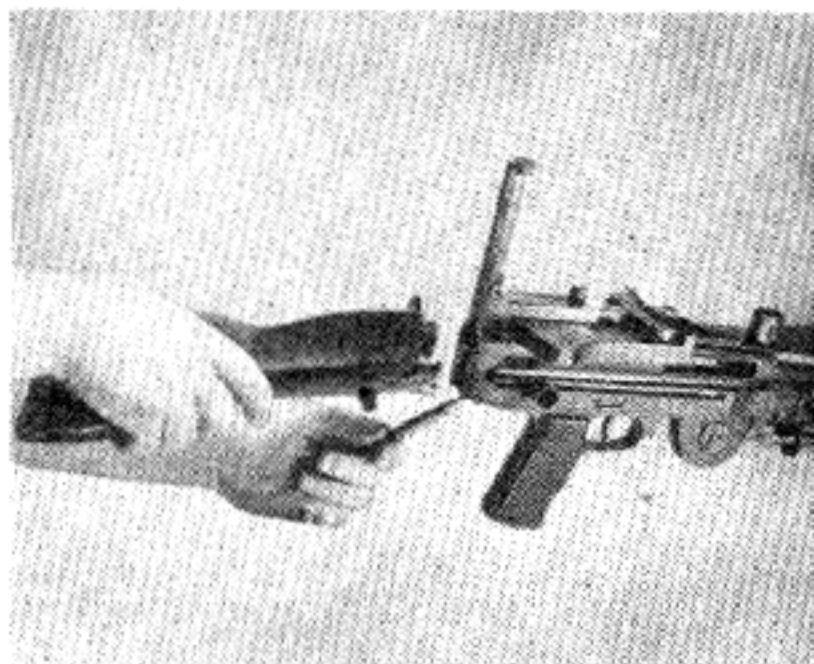

Insert the point of a bullet into the slot below the point of the butt where it joins the receiver. (In some British models there is a latch here which is pushed). Maintaining forward pressure with the bullet point, twist the butt stock up and to the left and pull it straight back to



the rear. Pull the trigger and draw back the trigger guard until it is a few inches out on the receiver, which will let the pinion casing (which contains the flat coiled main-spring) drop on its hook. This will also permit pulling the charging handle back

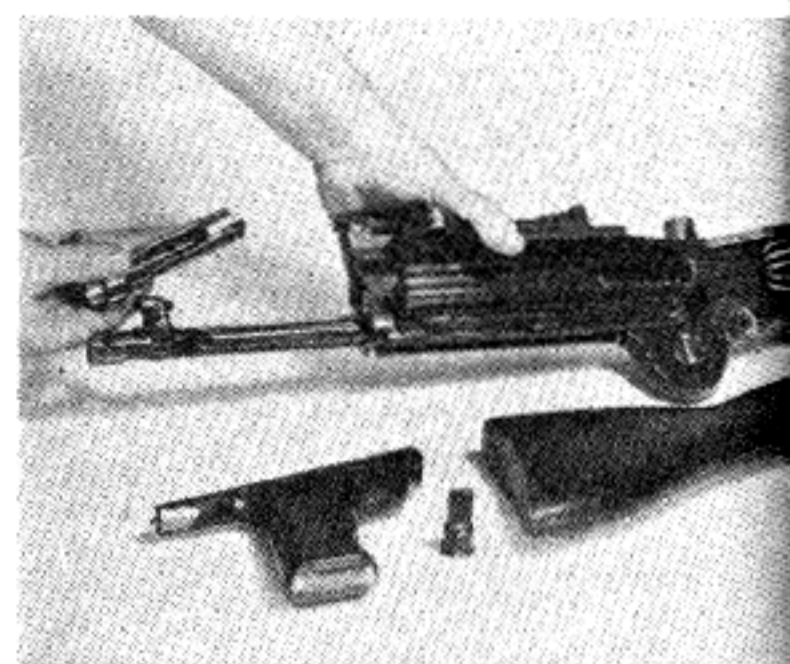

to the end of the receiver where it can be lifted out of its slot. Now pull out the trigger guard mechanism; and grasping the bolt and piston rod, draw them both back and completely out of the weapon.

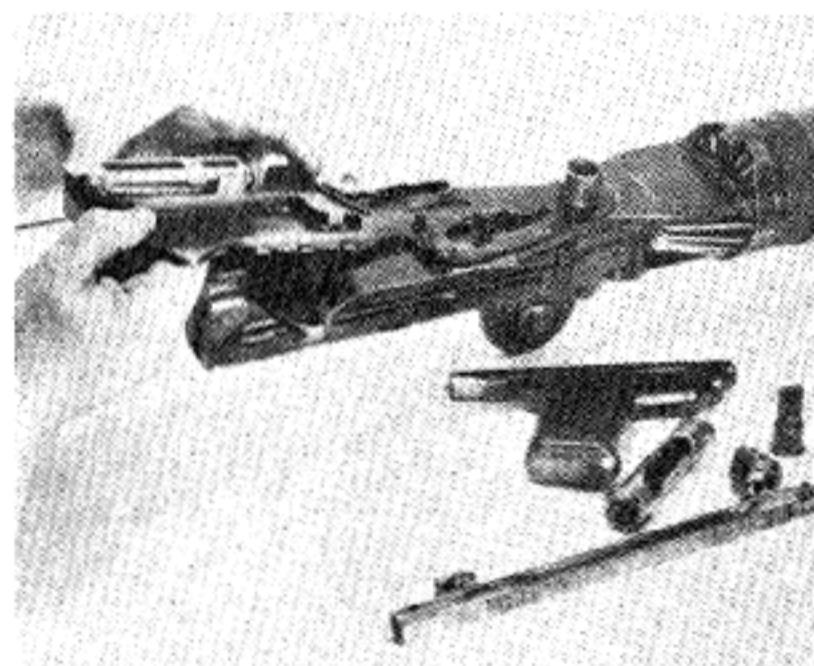

Gripping the feed cover (the flat piece on top of the receiver at the rear on which the rear sight is mounted) draw back about 1/2" and lift up and off. This exposes all the feed mechanism. Note that the feed arm should be over to the right before the cover can be pulled back.

Turn the feed arm and lift it off the magazine post. (In British guns, there is a latch at the front of the feed arm which

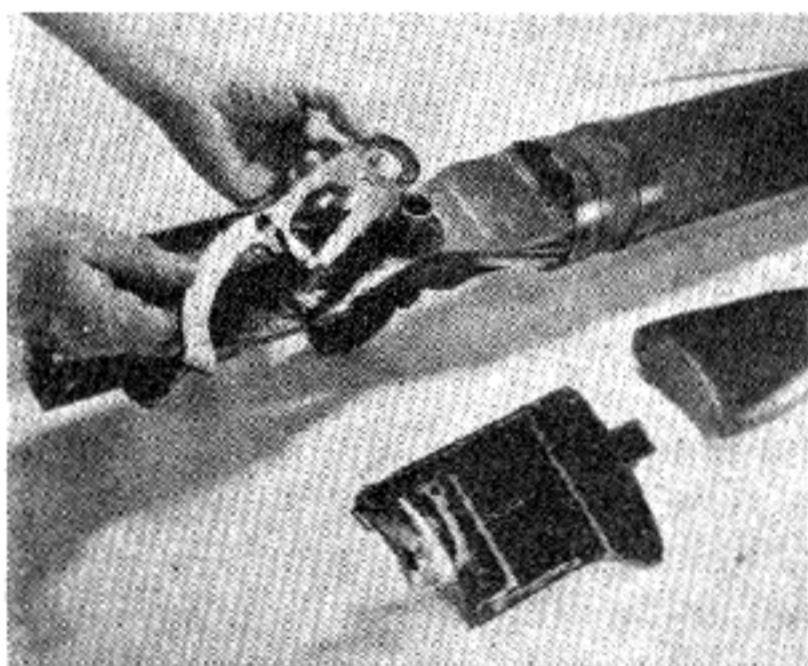

must be pushed back before the feed arm can be raised.) Midway along the feed arm is a pawl and its spring; the function of which is to push the magazine a notch as the feed arm moves to the left. These may be lifted off if necessary. Note: In the cover are the stop pawl and the rebound pawl, which lock into the edge of the magazine pan and hold it securely in place at the moment of feeding each cartridge;

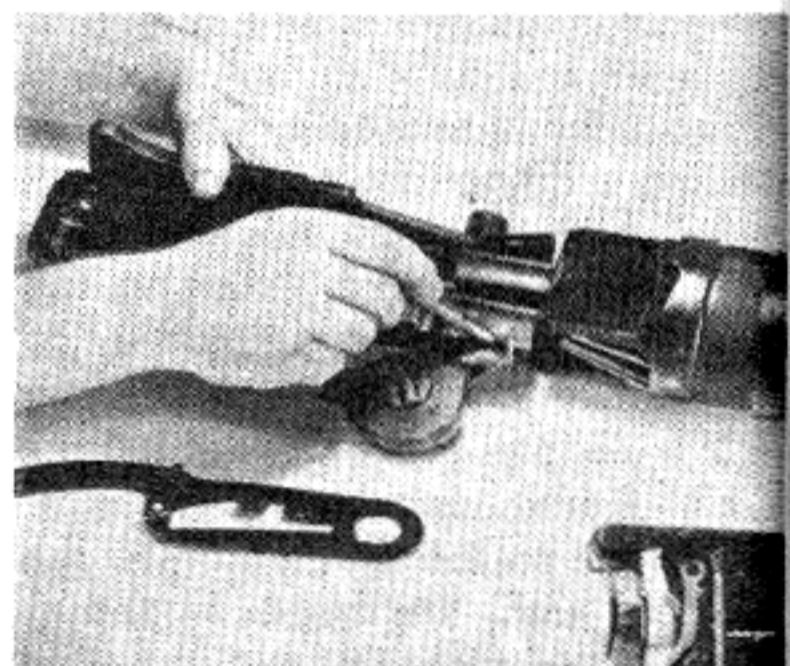

and a cartridge guide spring. All these may be pried out with the point of a bullet.

Pinion casing (housing the main spring) may be unhooked and removed. Receiver lock pin (at front end of receiver near the barrel) may be pushed with the point of a bullet; which frees the receiver so that it may be twisted up to the left.

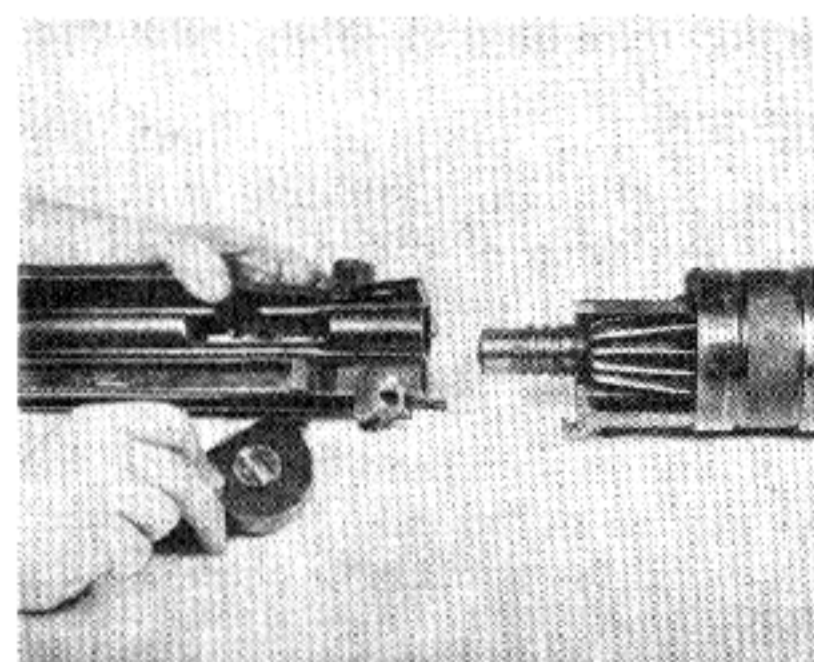

Receiver is then unscrewed completely from the barrel. Note: No further stripping is ordinarily necessary. However, to strip the barrel group for thorough cleaning, the following steps should be taken: With head of cartridge, unscrew clamp

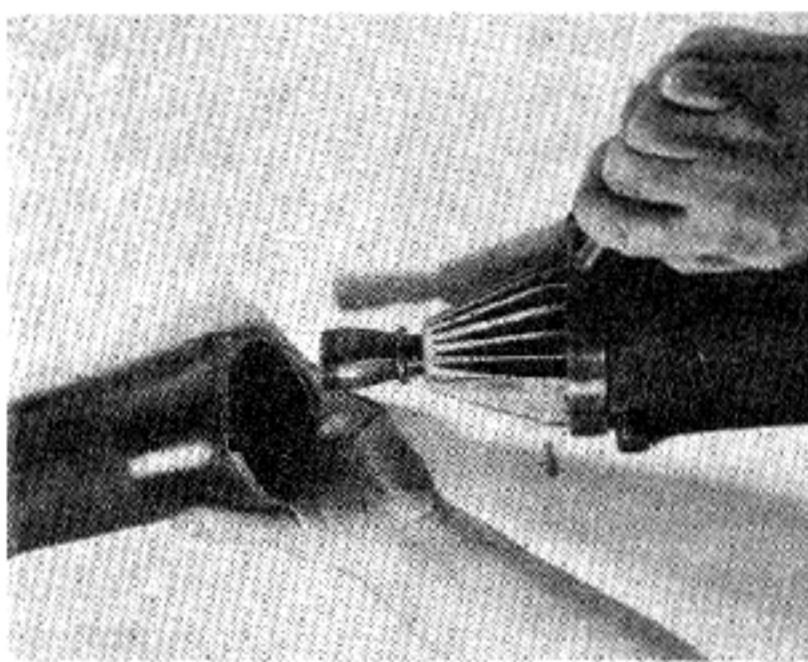

ring screw and lift off the front radiator casing.

Lift up the spring lever end of gas regulator key and unwind it until it can be removed. Slide off the bipod. Now pull out the rear radiator casing. The gas

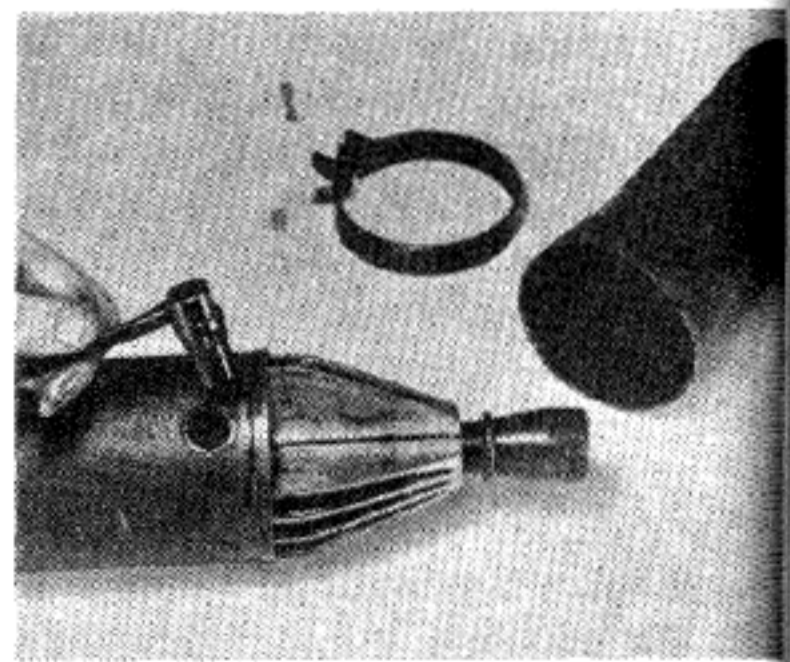

cylinder may now be removed using the pistol rod to unscrew it. A spanner must be used to remove the gas chamber and barrel mouth piece. (This mouth piece has a left hand thread.)



# BRITISH LEWIS .30-06 LIGHT MACHINE GUN

## HOW THE LEWIS MACHINE GUN WORKS

Starting with the gun cocked and loaded magazine in place, the action is as follows: The mainspring (or recoil spring) in this weapon resembles a heavy clock spring. It is housed in the pinion casing just forward of the trigger guard under the receiver. It is fitted in a gear box and on the under side of the piston teeth are cut to make a rack which engages with this gear.

As the trigger is pressed, the nose of the sear is released from the bent in the rear of the rack on the piston rod and the return spring is allowed to come into play and revolve the pinion. Since the teeth of the pinion are engaged with the teeth on the rack of the piston, the piston rod is driven violently forward. The bolt is mounted over the striker which is attached to the rear of the piston. As it moves forward the front top edge of the bolt strikes the lower edge of the rim of the cartridge positioned in the feedway, driving it forward and downward into the firing chamber.

As it nears the end of this forward movement, the resistance lugs on the rear of the bolt come out of their guide slots (machined into the receiver) and the projection called the operating post, which is mounted on the piston, continuing to move forward, presses against a curved slot in the bolt, revolving it. As the bolt locks behind the cartridge in the chamber, two extractors slip over the head of the cartridge, grasping it securely.

During this forward movement of bolt and operating rod, the rebound pawl (the small metal arm caught in the outside of the pan) has prevented the magazine from moving.

A stud on top of the bolt, riding in the groove on the underside of the feed operating arm has returned the arm to the right in preparation for picking up the next cartridge.

When the bolt has completely turned into the locked position, and the lugs are securely locked, the striker can continue straight ahead in the bolt slot and the firing pin passes through a hole in the center of the bolt to fire the cartridge. The bolt stays securely locked until after the bullet passes over the gas port in the barrel.

**Return Movement of the Action:** As the bullet passes

over the gas port on its way to the muzzle, a small portion of gas enters through the gas port into the gas regulator cup. Here it deposits any solid matter and the clean gas expands through an aperture in the gas regulator cup and the corresponding aperture in the wall of the gas chamber and comes back with a hammerlike blow against the head of the piston.

As it goes back, the rack on its underside, which is engaged with the gear, winds up the mainspring to provide energy for the next forward motion of the action.

The dual extractors pull the empty cartridge case out of the chamber and it is hurled out of the gun by the ejector, actuated by the feed operating stud striking against its rear end.

The operating post traveling back in straight line forces against the curved or cam slot in the bolt and rotates the bolt far enough to unlock the lugs and from that point carries the bolt back in straight line to the rear.

Meanwhile the feed operating stud mounted on the bolt riding in the channel on the underside of the curved feed operating arm, moves the arm over to the left, carrying a cartridge from the magazine under the cartridge guide spring and positioning it in the feedway on top of the receiver.

The feed pawl (which is carried by the feed operating arm, and which acts on the outside wall of the magazine pan) pushes the magazine through a part revolution far enough to bring the next cartridge into position. The **stop pawl** now engages in the wall of the magazine to hold the magazine in this new position while the **rebound pawl** prevents this magazine from bounding back. This prevents any movement of the magazine while the action is going forward.

The head of the operating rod and the bolt mounted on it strike against the butt tang at the extreme rear end of their movement. If the trigger has been released quickly enough, the sear will catch the piston and hold it to the rear. If the trigger is still depressed, the action will go forward and repeat the firing cycle.

## DESCRIPTION OF MAGAZINE

For a proper understanding of the operation of the Lewis gun, a knowledge of how the magazine pan works is necessary. A cartridge spacer ring carrying interior separators is fastened by a rivet to the magazine pan. Inside the pan itself is the magazine center; while outside is the magazine top plate, enclosing the magazine latch and the magazine latch spring. The magazine center and the top plate are fastened together by rivets.

The wall of the magazine pan has corrugations which from the outside serve to engage with the stop pawl and the rebound pawl to permit feeding and hold the magazine in proper place. Inside the pan these corrugations provide spaces in which the bases of the cartridges rest.

The magazine center is hollow and provided with a

keyway which fits over the magazine post and center key on top of the receiver, providing a locking arrangement.

When the magazine is not in use, the pan and the center are automatically locked together by the magazine latch which engages in a series of notches cut through the inside edge of the spacer ring. Thus when the magazine is to be loaded or unloaded, the latch must be held back to permit the pan to revolve around the magazine center.

It will be seen that the magazine center is locked securely to the magazine post on the gun; and as the pan revolves around the post, the cartridges which are individually supported by the separator pins are forced down and around the spiral and one by one brought in line by the feedway.



# BRITISH LEWIS .30-06 LIGHT MACHINE GUN

## NOTE ON COOLING SYSTEM OF LEWIS GUN

A very ingenious cooling system is employed in this gun. A barrel mouthpiece is screwed over the end of the barrel and has a cone shaped interior. As the bullet leaves the muzzle, the expanding gases strike against the cone shaped interior of this barrel mouth piece, rebound and strike against the front end of the radiator casing, thus forcing all the air out in front of them. This creates a suction behind which draws a current of air from the rear of the gun through the rear casing and around the aluminum flanges of the radiator. The aluminum radiator is in contact with the barrel throughout its length and

theoretically draws heat from the barrel. Thus while the gun is firing, a constant stream of air is being sucked over the radiator.

While this system is theoretically very valuable, in actual practice the amount of heat so dissipated is not of any particular importance. In other words, the Lewis gun without the cooling device will perform just about as well as it will with it. This fact is generally understood by engineers; but would probably be classed as heresy by the avowed Lewis gun enthusiasts. However, tests speak for themselves.

## SPECIAL NOTE ON THE LEWIS GUN

The Lewis gun is still extensively used by our Coast Guard units and some branches of the Navy. Both the United States and the British type (which are practically identical) have been imitated line for line and piece for piece by the Japanese. Regular ground-type Lewis guns equipped with aluminum radiators and regular rifle-type butts, stripped-type Lewis guns with spade grips and minus the cooling device, and special dual purpose mounted Lewis guns with trick feeding devices have been developed and are in wide use by the Japanese. The British make very extensive use of Lewis guns, particularly aboard small craft. These guns are credited in the

present war by the British with destroying more low flying aircraft than any other type of weapon employed by them. While the Lewis is no longer a first line weapon, it is still one of the most useful light machine guns ever developed.

Stripped-type Lewis guns usually are equipped with anti-aircraft sights. They will also handle special oversize magazine with a cartridge capacity of 97-rounds. If these magazines are used on the standard type gun, they interfere with the line of sight unless the gun is equipped with special sights.

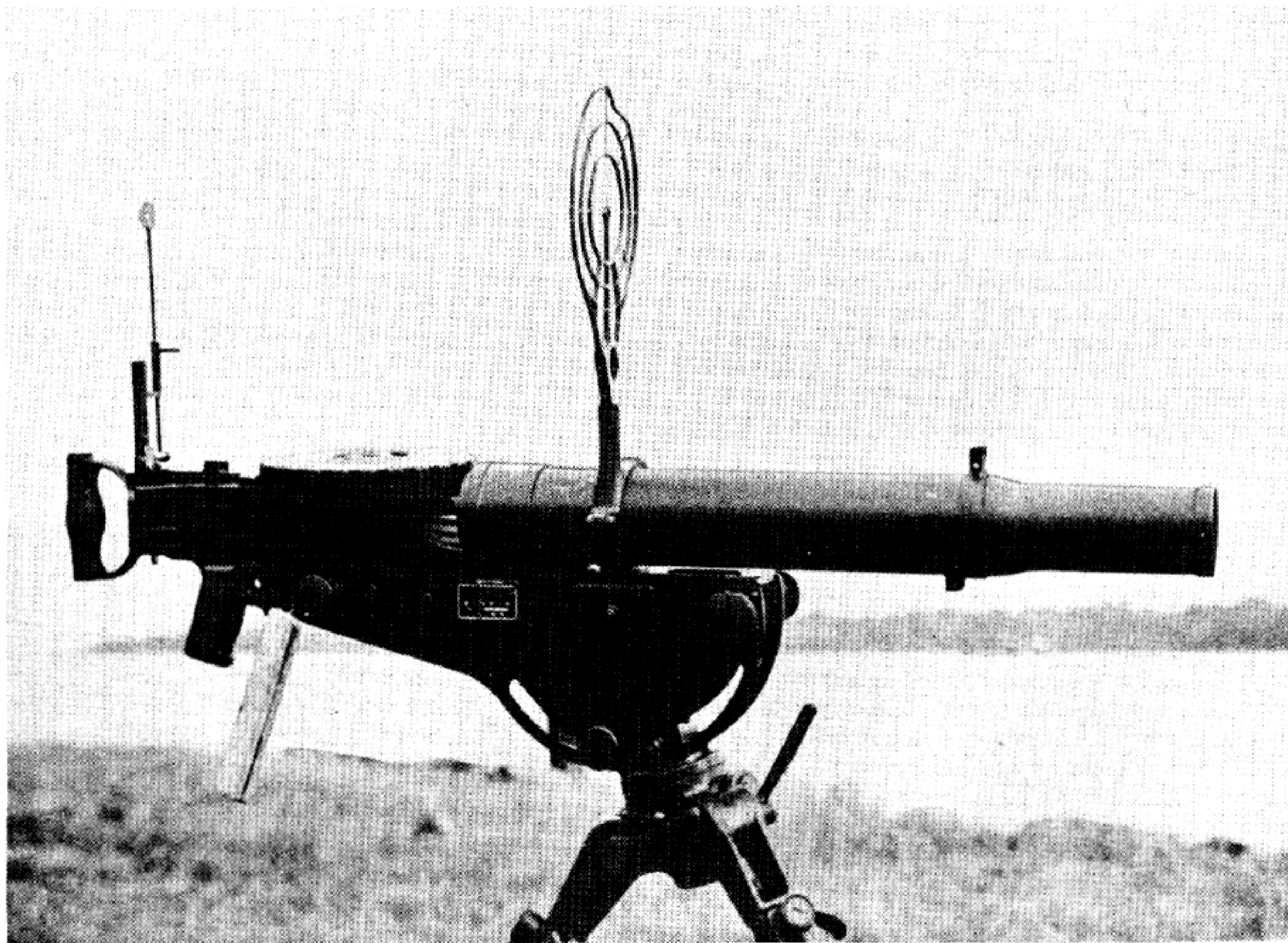

Lewis Gun Used by Japs. Special Mount and A A Sights



# BRITISH LEWIS .30-06 LIGHT MACHINE GUN

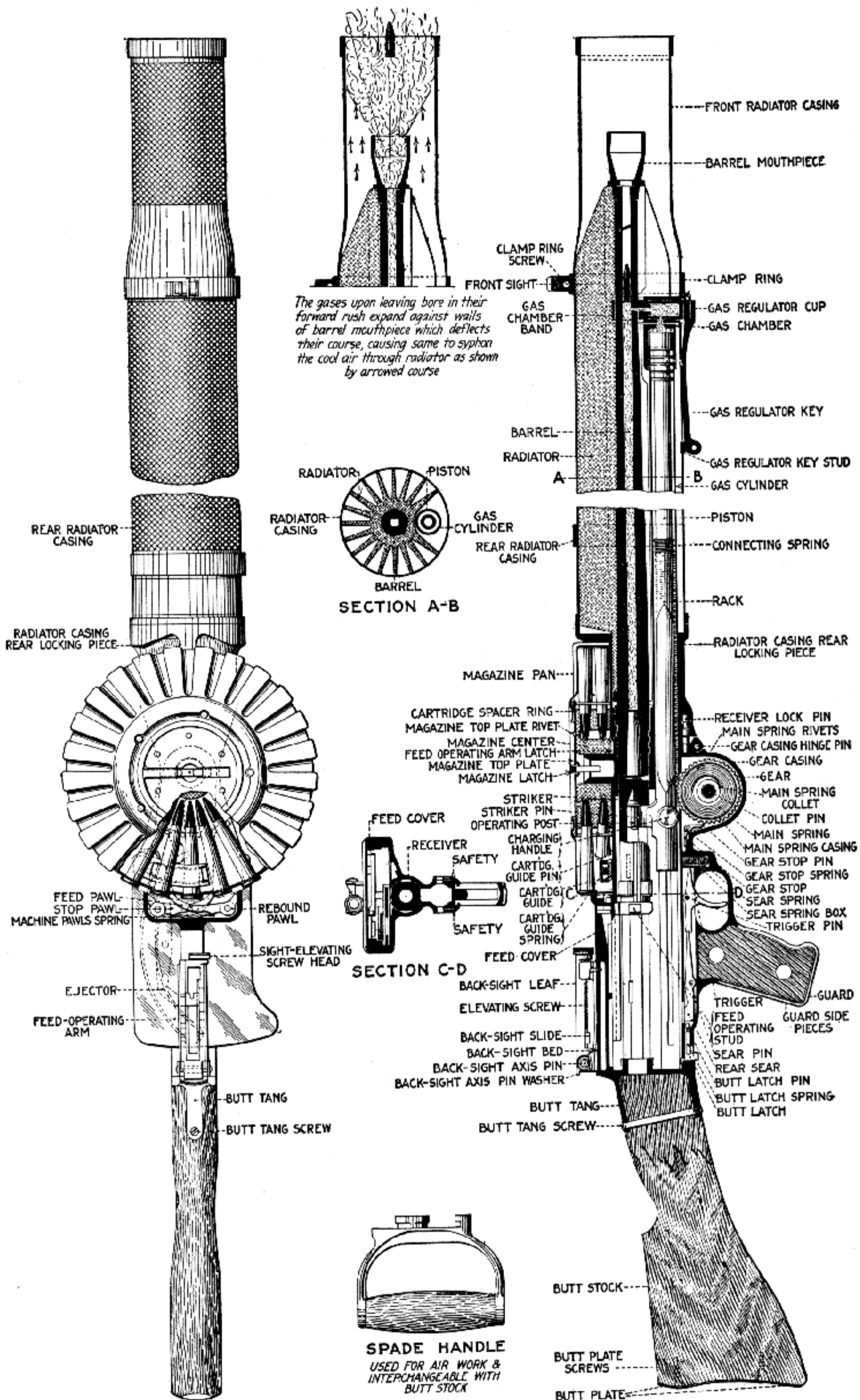

Courtesy McGraw-Hill Book Company



# BRITISH BESA MACHINE GUN

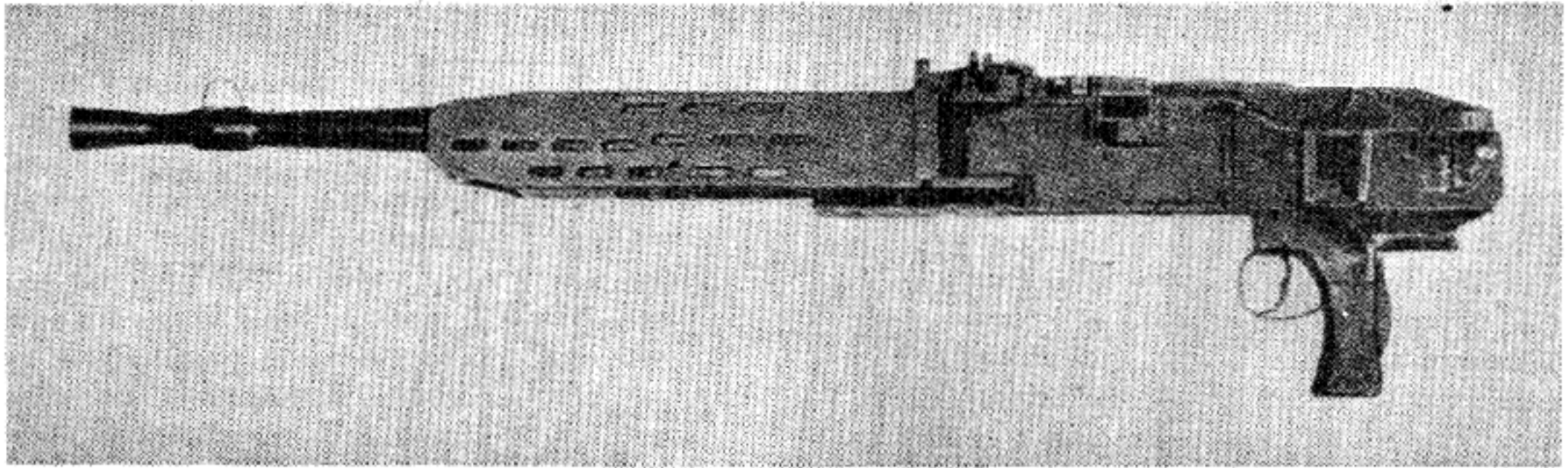

These guns are widely used in armored vehicles by the British. They do **not** use the standard British .303 cartridge. They were specially developed for a 7.92mm cartridge, and the standard German rifle and machine gun ammunition may be used in them. Mark I indicates that the gun is converted from a ground pattern. Mark II indicates that it is a specially manufactured gun for armored vehicle use.

Differences are comparatively minor. The mounting base on the Mark II is integral with the body while that on the earlier model is a shoe riveted to the underside of the body. In the Mark II the trigger guard catch housing is integral with the body; while in the Mark I the catch is housed in a blanket riveted to the rear of the gun. Different trigger guard catches are used, as the cover and trigger guard of the Mark I are larger than those of the later model. Trigger catch in the Mark I is held by a screw in the body, while that in the Mark II is held by a stop pin in the return spring guide. The accelerator arms in the two models are different. Mark II barrels, cover catches, flash eliminators, and return spring guides may be fitted directly to the Mark I guns.

**Caliber:** 7.92mm British or German manufacture.

**Feed:** Metal belts, holding 225 rounds.

**Muzzle Velocity:** About 2650 feet per second.

**Barrel Length:** 2' 5" including Flash Hider.

**Overall Length of Gun:** 3' 7½".

**Weight Without Belt:** 47 lbs. for the Mark I and 48 lbs. for the Mark II.

**Weight of Loaded 225-round metal belt:** about 18 lbs.  
**Sight:** Telescopic.

**Maximum Range:** 1500 yards are the accurate limits of the telescope.

**Gun Operated By:** Gas. This is an unusual design. The rearward recoils from the explosion in the firing chamber drives the breech block, piston, barrel extension and barrel to the rear locked as one unit; while some gas escaping through barrel vent into gas cylinder then drives the piston back to unlock, eject and prepare the gun for the forward motion.

**Locked:** Securely locked by breech block at moment of discharge.

**Cooled:** Air. Weapon is fitted with a heavy barrel and a radiator casing. This gun fires from an open bolt which permits circulation of air through barrel during cessation of fire.

**Cyclic Rate of Fire:** This gun is fitted with a special accelerating device. When this is set at "L," rate is 450 to 550 per minute. When accelerator is set at "H," rate is 750 to 850 rounds per minute.

**Type of Fire:** Full automatic. Empty belt is ejected from the gun.

**Flash Hider:** A wide mouth extension is added to the front end of the barrel serving to hide the flash of unburned powder which ignites as it leaves the barrel.

## LOADING AND FIRING

The trigger guard is part of a heavy steel unit called the trigger guard body. Press forward the cocking catch thumbpiece which is mounted on the left side of the trigger guard body to disengage the cocking catch which is in a recess in the underside of the receiver. Be careful not to touch the trigger.

Push the trigger guard body forward and the sear will click into engagement in a bent in the piston extension.

Still keeping the finger away from the trigger, and holding firmly to the pistol grip, pull the trigger guard body back with a quick motion. This withdraws the working parts and compresses the return spring. The operating parts will be held to the rear by the sear which is now engaged in the bent of the piston extension; while the cocking catch engages in a recess in the underside of the receiver, and locks the trigger guard in firing position.

Push the tab-end of the belt through the feed block

from the **right side** and pull through the left as far as possible. This places the first cartridge in line with the chamber, bullet pointing downwards. The weapon is now ready to fire.

The pistol grip of the trigger guard body in this weapon is fitted with a grip safety somewhat like the one in the Colt .45 automatic. With finger on trigger, compress the hand to push in the safety catch lever. This will rotate the safety catch to the rear until it clears the underside of the sear; and as the trigger is pressed, the sear is pulled out of the bent of the piston extension permitting the return spring to force the working parts forward. The gun will now fire as long as the trigger is held back and the safety catch lever is kept depressed. The gun will stay open between shots when trigger is released.

**Note:** When the belt is emptied, it is expelled from the gun; but the action will go forward to close on an empty chamber.



# BRITISH BESA MACHINE GUN

## UNLOADING

Release feed pawl depressor lever which will free the feed pawl from engagement with the belt. Open cover to release retaining pawl which permits engagement

with belt links.

Lift out the belt. Close the cover, lower the depressor lever and ease the working parts forward.

## FIELD STRIPPING

See that the gun is cocked.

Pull the barrel retainer carrying handle up about half an inch and push it forward until it rests on the ramp. Press in the cover catch, push the carrying handle straight forward, then belt the handle upright with the palm of the hand.

Lift the rear of the barrel until it clears the barrel extension, then ease it forward. This frees the slides on the barrel sleeve from their guides in the body and permits the barrel to be pulled out.

Remove the body cover. Pull the cover locking pin out as far as it will go, press in on the cover catch, and lift the cover. Raise it until it can be lifted out of the body (receiver).

Press in the catch on the belt guide and lift it out of the receiver. Lift out the feed block and remove the feed slide.

The breech block may now be lifted out.

Now pull the exposed accelerator arm and plunger

cap outwards, pull up the crank arm and lift out the accelerator.

Maintain downward pressure on the barrel extension with the left hand and ease the working parts forward. Pull the trigger guard to the rear.

Push the return spring guide block ahead until it clears the guides in the receiver then lift it up. The guide lock and return spring may now all be removed.

Grasp piston with the right hand and the rear end of the barrel extension with the left and lift both pieces out, then slide out the piston.

The feed lever may now be inclined inward and lifted out of the weapon.

At the rear of the receiver is the trigger guard catch. Raise this, press the trigger guard easily to the rear to its fullest extent. Then release the trigger, jerk back on the trigger guard till it clears the gun, then lower the catch.

## FIELD ASSEMBLY

Reverse the stripping procedure. Start by replacing the trigger guard, and make sure that it is in its normal position. In replacing feed lever check that the upper arm is slightly to the right so it will engage correctly its stud with the groove in the piston.

In assembling barrel extension and piston, take care that the upper flange on the piston engages in the lower groove in extension. Work piston backwards and forwards when inserted to be sure that stud on lower arm of feed lever is properly engaged with piston extension groove.

Place return spring in piston, and while holding the spring firmly, place the guide rod in the spring, push

forward until the rod enters the piston extension. Then press the guide lock down into the receiver and release the pressure. This will permit the spring to position the guide lock properly.

Hold the barrel extension down with the left hand while cocking the gun with the right and replace accelerator, breech block, feed block body and feed slide assembly. Be sure that the stud on the feed slide engages in the slot of the upper arm of the feed lever belt guide.

When replacing the body cover, check that the cover bearings engage properly with the body trunnions.

## BARREL REPLACEMENT

Keeping rear end of the barrel elevated, insert the slides on the barrel sleeve in the guides on the body. Then draw the barrel to the rear until the flanges at the breech end of the barrel are just above the grooves in the barrel extension. Then lower the barrel into the

barrel extension, push the carrying handle over to the right until it rests on the ramp, strike it back sharply with the palm of the hand and push the handle down to lock the barrel.

## HOW THE BESA GUN WORKS

Starting with the gun loaded and cocked, the action is as follows: As the safety catch lever is squeezed in, the trigger is free to engage with the sear, drawing it out of the bent in the piston extension and permitting the return spring to start the piston and moving parts forward.

As the piston and piston extension move ahead, the extension acts to move the breech block ahead, a projection on the front of the block strikes the rim of the cartridge in front of it, strips it out of the belt and chambers it.

The extractor rides up over the cannellure of the cartridge during the closing movement of the breech block and snaps into engagement.

As the rear end of the breech block is lifted, it disengages from the shallow stop in the piston extension by engaging with projections in the barrel extension. It rides up an incline plane and engages with a resistance face on the barrel extension.

As the breech block locks, the piston extension carrying the piston post against the firing pins discharges the cartridge.



# BRITISH BESA MACHINE GUN

Also during the forward movement, the piston extension acts on the lower arm of the feed lever moving the upper arm and the feed pawl over to the right permitting the feed pawl to be depressed by the belt and cartridge and engage in the link of the third round

in the belt.

The retaining pawl is engaged behind the link of the cartridge just stripped into the firing chamber and holds the belt stationary during the movement.

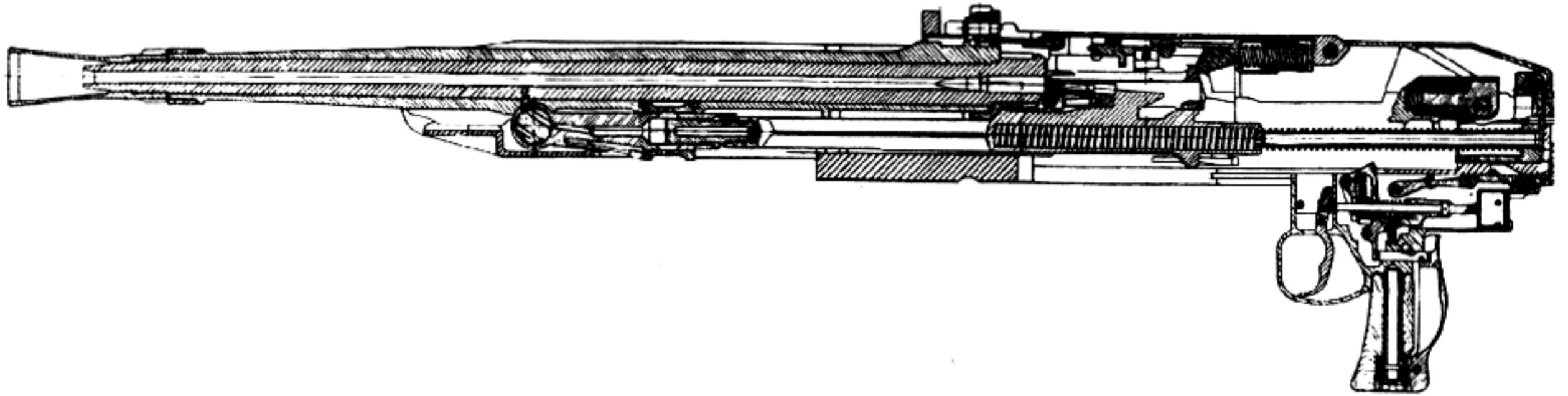

## RETURN MOVEMENT OF THE ACTION

As the cartridge in the chamber is exploded, the bullet moves down the barrel and the rearward thrust of the recoil bearing against the cartridge case forces the breech block, piston, barrel extension and barrel to the rear as a unit. The barrel extension presses against

the recoil spring in the cover easing the rearward motion; and after the initial shock the barrel extension and barrel are forced forward by the action of the recoil spring.

## GAS ACTION

As the bullet passes over the gas vent in the barrel, some gas escapes through and into the gas cylinder, then through the gas regulator to strike a sharp blow against the piston head.

This sudden thrust drives the piston and its extension to the rear, and the inclined ramp on the piston post bearing against the breech block lowers the rear end of the block out of engagement with the resistance space at the rear of the barrel extension, unlocking the weapon.

Further rearward motion of the piston extension pulls the breech block clear of the barrel. The extractor draws the fired case out of the chamber until the base of the empty cartridge case strikes the ejector, which is a fixed projection on the belt guide. This snaps the

case free from the breech block, permitting the extractor to snap back into place, and the empty is hurled through a slot in the piston extension and out the ejection opening in the bottom of the receiver. Also during the backward movement of the piston extension, the return spring is compressed between its place in the extension and the return spring guide lock.

If the trigger has been released, the sear spring will reassert itself and push the nose of the sear into engagement with the bent of the piston extension holding it to the rear. If the trigger is kept depressed, on completion of rearward motion the return spring will drive the piston and other moving parts forward and the cycle of firing will be repeated.

## THE ACCELERATOR

When the accelerator is set in its high position, the rear of the piston extension will not make contact with the accelerator and the gun will fire at its normal rate of 450 to 550 per minute.

If, however, the accelerator is set in its low position, the complete backward motion of the piston extension is halted by the rear of the extension striking the front face of the accelerator. This forces the accelerator

casing to the rear, thereby compressing the heavy accelerator springs. Thus, when the forward movement starts, the operating parts are forced forward not only by the return spring, but also by the accelerator springs. This extra spring action speeds up the forward movement of the working parts and the rate of fire is increased to 750 to 850 shots per minute.



# BRITISH BESA MACHINE GUN

## BRITISH BESA MACHINE GUN, CALIBER 15mm, MARK 1

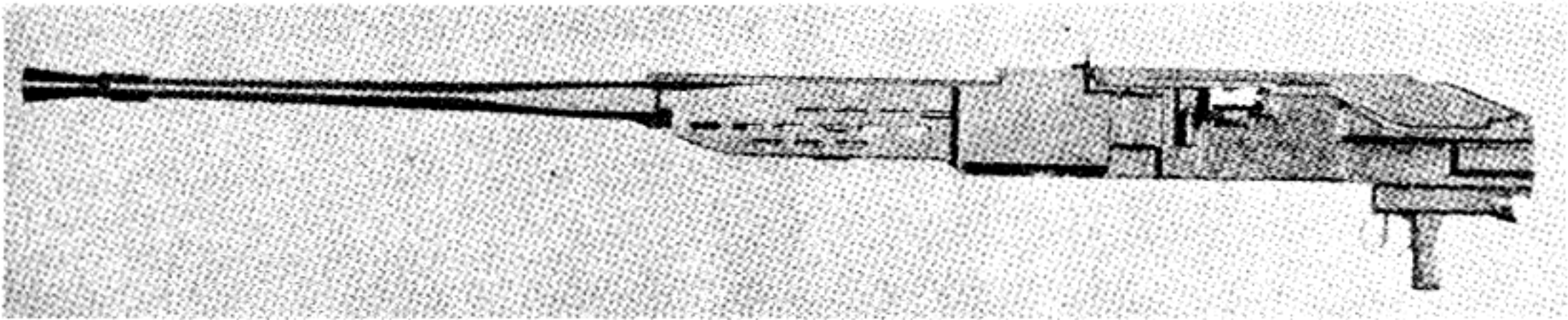
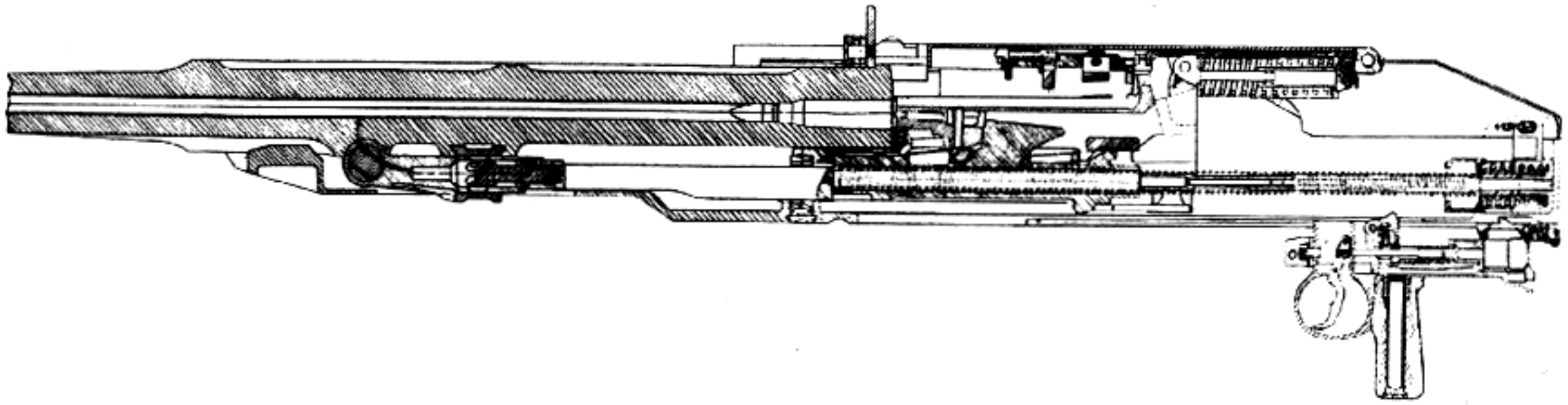

This is a heavy model of the original Besa Machine Gun developed for use in armored vehicles. Its handling and functioning is much the same as the smaller calibre. It is not equipped with an accelerator as is the lower powered weapons, but it is fitted with a change lever device permitting single shot or full automatic fire.

**Caliber:** 15mm Mark I.

**Feed:** Metal belt holding 25-cartridges.

**Muzzle Velocity:** Approximately 3,000 feet per second.

**Barrel Length:** About 57" including the flash hider.

**Overall Length of Gun:** About 81".

**Weight:** 125½ lbs.

**Barrel Weight:** About 48 lbs.

**Weight of Filled Belt:** About 12 lbs. 4 ozs.

**Sight:** Telescopic maximum range limit 1800 yards.

**Gun Operated By:** Gas. Same as lighter model.

**Locked:** Rising breech block, same as small model Besa.

**Cooled:** Air. Fires from open bolt.

**Cyclic Rate of Fire:** 400 to 500 per minute.

**Cocked:** Same as the lighter gun. Cocking catch on trigger guard body is pressed forward. Then the trigger guard assembly is pushed forward as far as it will go. Pulling trigger guard to the rear smartly until it is held back, complete cocking the gun.

**Type of Fire:** Single shot or full automatic. Move the change lever to the right as far as it will go for full automatic fire. Change lever is in center position, weapon is "Safe." When change lever is pushed to the left as far as it will go, trigger must be pressed for each shot.

**Special Note on Besa Guns:** These guns were originally designed by Czech engineers. With some unimportant modifications, they are widely used in German tanks.

### BARREL REMOVAL

Removing the barrel on this model is a two man job. While one man holds the barrel, the other raises the carrying handle of the barrel retainer a half-inch and pushes the handle forward until it can be turned up. About 13" from the breech-end a special slot is pro-

vided to permit this action.

Second man now raises the rear end of the barrel until it clears the barrel extension, then both ease it forward and lift it out. Slides on the barrel are freed from the guides of the body by this forward motion.



# BRITISH VICKERS .303 MACHINE GUN

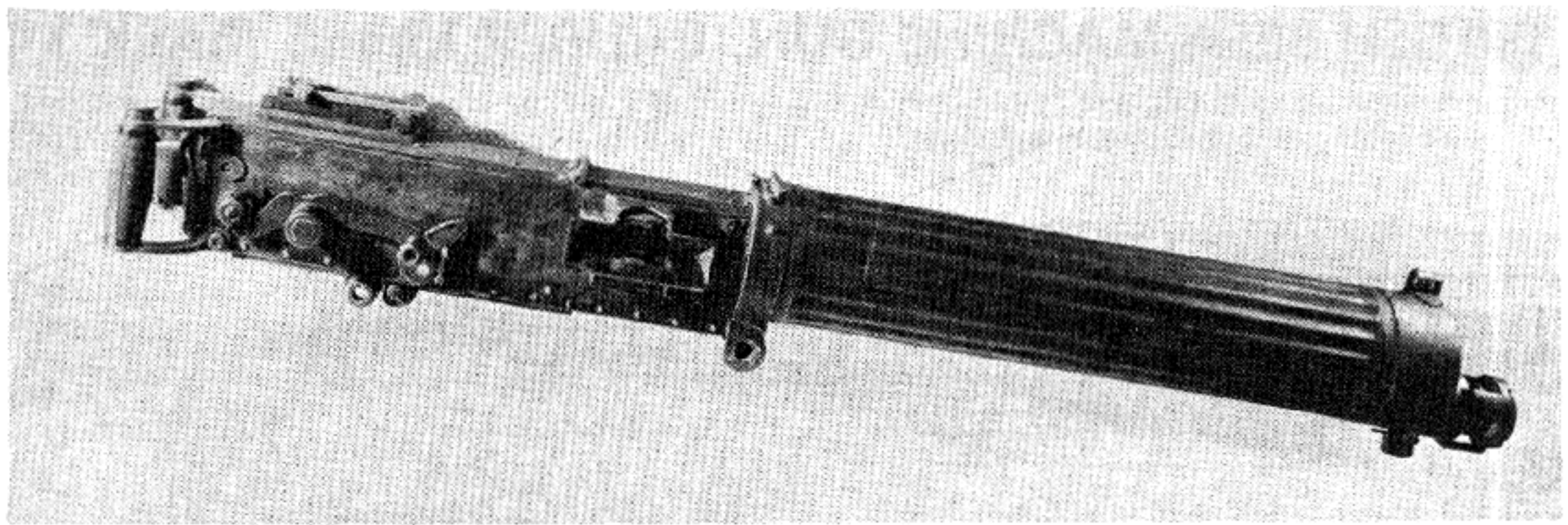

**Caliber:** .303 British Mark VII Ammunition.

.30 MI U. S. Ammunition.

(Note: Ammunition **not** interchangeable.)

**Method of Feeding:** Fabric belt containing 250 rounds.

(When mounted in aircraft, these guns are fitted with belts made of disintegrating steel links.)

**Ballistical Data:** Standard for .303 British or .30 MI U. S. Ammunition.

**Length of Barrel:** 24½". (In early models 28¾" barrel.)

**Overall Length of Gun:** About 3' 8".

**Weight of Gun With Water Jacket Empty:** About 33 lbs. With jacket filled, about 10 lbs. heavier.

**Weight of Loaded Ammunition Belt:** With .30 U. S. Ammunition about 15 lbs.

**Sights:** Blade front sight. Rear sights differ in different guns, but all have calibrated leaf sights. Aperture on the average sight normally used has adjustable plate with 5 different sized apertures. Adjustable for windage. In American types drift is also allowed for as in the sight on the Springfield rifle.

**Elevation Provided For:** Varies. 0 to 2400 meters on some sights, 0 to 4000 yards on other sights.

**Accurate Range:** About 600 yards. (Effective and maximum ranges much greater.)

**Gun Operated By:** Recoil. The barrel and locking mechanism recoil together a short distance; then the barrel is stopped and the recoiling mechanism continues backward to work the weapon. This recoil is insufficient in itself to operate the gun properly; so a device fitted over the muzzle utilizes gas escaping after the bullet has left the barrel. The expanding muzzle gases strike the front cone of the ball firing attachment and rebound violently against the front of a muzzle cup, adding to the backward thrust of the barrel.

## LOADING THE GUN

1. Under normal firing conditions, the rear leg of the tripod will be aligned with the target. The gunner sits behind the gun to the rear of this leg with his legs on either side of the tripod. The knees are drawn up slightly so that the elbows can rest on the inside of his thighs while his hands grasp the traversing handle.

2. **Proper Hand Position:** Both thumbs are rested lightly on the thumb trigger. The forefingers are wrapped around the top of the handle. The second fingers are placed underneath the ring safety catch. The other two fingers on each hand grasp the traversing handles firmly but without strain.

**Locked:** By toggle joint. Barrel, lock and operating mechanism all move back locked together until bullet has left barrel; then the toggle buckles in the same fashion as a human knee when it bends, drawing the lock straight to the rear, while the barrel is stopped in its backward motion after traveling something over ½".

**Cooled:** Water; there is watertight jacket fitting around the barrel. This is filled with water and absorbs the heat generated in the barrel, and if steam develops it is taken off through a hose attached to a condenser bucket.

**Cyclic Rate of Fire:** 500 rounds per minute.

**Position of Crank Handle and Lock When Weapon is Ready to Fire:** Fully forward. In this machine gun the lock and barrel are firmly locked together when the weapon is cocked ready for firing.

**Type of Fire:** Full automatic only. Should single shot fire be desired for any reason, withdraw alternate cartridges from the cartridge belt. Under this system, the rocker handle must be pulled back to load the weapon after each shot.

**Safety:** A ring safety catch is provided at the rear of the weapon between the two handles. The trigger is a thumb-piece directly below this ring, and the ring **must be lifted** by the fingers before the trigger can be pushed in by the thumb.

This gun is normally mounted on a tripod mount. The folding mount weighs 52 lbs.

**Firing Procedure:** This type of gun is normally fired in bursts of 10- to 20-rounds. 60-shots a minute is rated as slow fire; 125 a minute as medium fire, and 250 a minute as rapid fire.

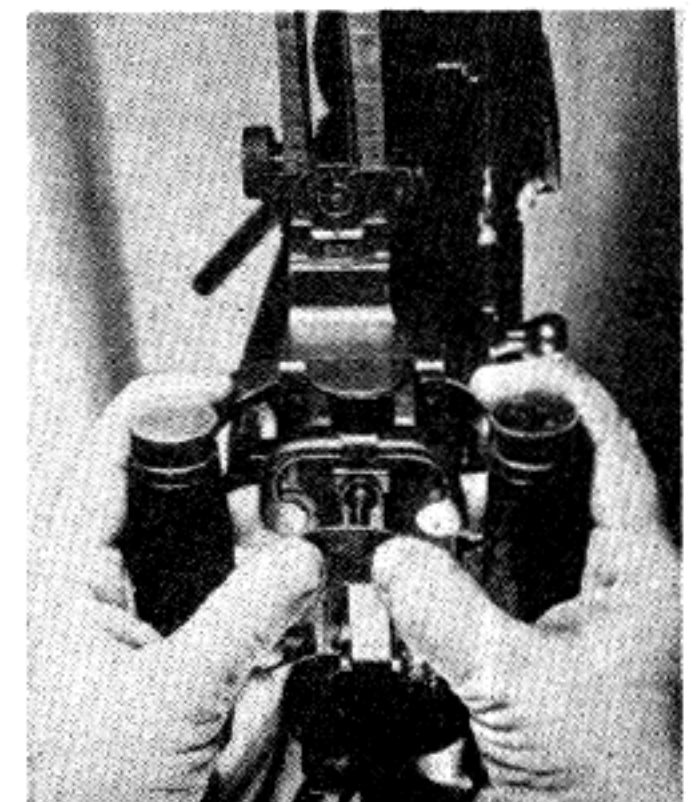



# BRITISH VICKERS .303 MACHINE GUN

3. To load. See that ammunition box is placed on right side of gun directly below the feed block.

If the gun is equipped with a shutter, open the shutter.

Pass the brass tag-end of the belt through the feed block from the right side and grasp it firmly with the left hand.

With the right hand pull the crank handle back on its roller as far as it will go, **and while holding it in that position**, pull the belt sharply through the feed block with the left hand as far as it will go.

Release the crank handle and let it fly forward under the influence of the spring. This action grips the first

cartridge firmly between upper and lower portions of a gib at the top of the extractor. Now pull the crank handle back on its roller once again. Give the belt **another** sharp tug to the left as far as it will go, and **again** let the crank handle fly forward under the influence of the spring. This action withdraws the cartridge from the belt, places it in the chamber ready for firing and grips the next cartridge by the gib in the upper part of the extractor.

The gun is now cocked and ready to fire, whenever the safety catch is lifted and the trigger pushed in.

## FIRING THE GUN

With fore fingers wrapped over the top of the traversing handle, raise the safety catch with the second fingers of the hands, wrap the other fingers around the traversing handles, and with both thumbs press in on the thumb trigger.

The gun will now fire as long as the trigger is kept

pushed in and cartridges are fed into the gun. Releasing either trigger or safety will stop the gun.

Remember that this gun is supported by the tripod, and that the hands are intended only for use in firing. Thus no particular effort is required on the part of the gunner.

## NOTE ON UNLOADING

Because of the method of feeding, safely unloading this weapon requires special consideration. **Without touching the belt**, pull the crank handle back onto the roller as far as it will go and release it.

Again pull the crank handle back as far as it will go and permit it to fly forward. The first motion of the crank handle extracts the cartridge from the firing chamber, and drops or ejects it through the bottom of the gun. The cartridge in the feed block is withdrawn for positioning by this movement, and is fed into the chamber, but as the belt is **not moved across**, no new cartridge is gripped by the top of the extractor. Thus when the crank handle is run back for the second time,

the second live cartridge is dropped through the bottom of the gun, leaving the firing mechanism empty.

With the left hand raise the finger plate of the bottom pawls and simultaneously push down the top pawl by squeezing the pawl grips. Keeping the pawls disengaged, pull the belt out of the block to the right. The pawls hold the belt in position in the feed block; the top pawls being behind the first cartridge and the bottom pawls behind the second. During recoil of the gun the top pawls feed the cartridge into position while the bottom ones prevent any backward lash of the belt, thus it is necessary to release the pawls from their position before the belt can be pulled out of the gun.

## HOW THE GUN WORKS

**Starting with the gun loaded and cocked the action is as follows:** The safety catch is normally held down by a spring which also holds the firing lever to the rear. This catch prevents any forward movement of the firing lever while it is in safe position. When this catch is raised by the second finger, it clears the way for the thumb-piece of the firing lever to push the lower end of the trigger bar forward. The trigger bar lever is engaged with the trigger bar in the rear cover and as the lever moves back it draws the trigger bar to the rear also.

The forward end of the trigger bar is in engagement with the trigger situated in the lock; and as the trigger moves to the rear, it releases the striker, contained in the lock, from its spring and the striker is driven forward to fire the cartridge in the chamber.

As the cartridge explodes, the bullet is driven down the barrel and the locked barrel and locking mechanism start rearward.

As the bullet leaves the barrel, the gases behind it expand in the muzzle attachment. Some of these gases strike against a cone which surround the hole through which the bullet passes and rebound to strike the front face of the muzzle cap cup, fastened over the muzzle.

Thus it will be seen that the rearward action of this gun is brought about by two forces. 1: By recoil (the

rearward thrust or gases in the barrel against the head of the cartridge and the lock as the bullet is forced ahead); and 2: By the effect of the rebounding gases after the bullet has left the muzzle, giving an added backward push against the muzzle cup.

On the rear of the left side plate is a protruding metal box. A powerful fusee spring is attached to the front end of this box. The rear end of the box is locked in position to the body of the gun. At the front end of this box is the fusee which is attached to the fusee spring. The rear of this spring, being attached to the fusee, can be drawn straight backwards, extending the spring and storing up energy to provide the return movement of the action. The recoil forces the tail of the crank handle to roll against its roller and rotate the crank, which is attached to the fusee. This winds the fusee chain and extends the fusee spring while the lock is traveling to the rear. The sharp backward thrust caused by the recoil forces the lock, crank and crank handle to move back as the crank handle continues to roll against the roller.

While the mechanism is moving backward, a stud on the bottom lever of the feed block located in a **recess in a prolongation of the left side plate** is forced to the rear, taking with it the bottom lever, which being con-



# BRITISH VICKERS .303 MACHINE GUN

ected with the top lever, carries the bottom one over to the right, thus causing the feed block slide to move over to the right. This movement causes the top pawls in the feed block to drive to the right and slip over and behind the next cartridge in the belt, which is being held in place by the bottom pawl.

Meanwhile the lock has been moving backwards. The extractor attached to it removes the loaded cartridge from the belt at the same time it draws the empty cartridge case from the chamber. Horns on this extractor ride along the top of solid cams in the breech casing sides; and as the cartridge is drawn clear of the belt, the horns clear the ends of these cams. Rims in the rear cover force the extractor downward and bring the live cartridge into line with the chamber. During this downward movement of the extractor, the empty cartridge case usually drops out. If it fails to, it will be ejected during the forward movement of the extractor. The loaded cartridge is held firmly in position in the extractor by the gib which has a **bottom projection to prevent the cartridge from slipping down out**

## RETURN MOVEMENT OF THE ACTION

The force of the recoil having expended itself, the stretched fusee spring now reasserts itself, unwinds the fusee chain, moves the link to rotate the crank in the forward direction; forces the connecting rod and side lever head to drive the lock forward.

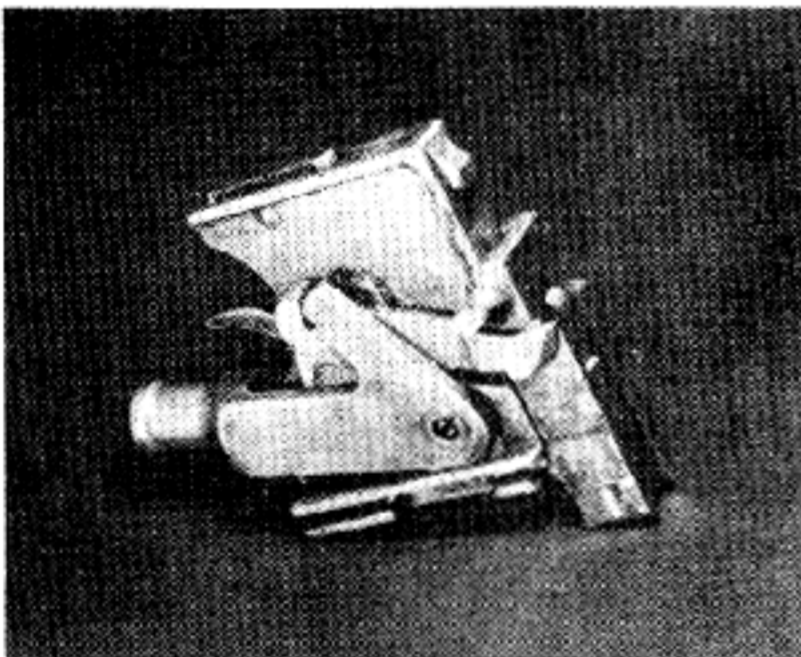

Vickers  
Lock.

The stud of the bottom lever of the feed block is carried forward in its recess in the prolongation of the side plate, moves the bottom lever of the feed block forward, thus causing the top lever and the slide to move over **to the left**. As the pawls move and are gripping the next cartridge in the belt, the loaded cartridge is moved into position against the cartridge stops, ready to be gripped by the extractor on the next rearward movement.

As the lock is driven forward, the extractor in its face is carrying the cartridge in position supported by the gib to feed into the firing chamber.

The extractor is now raised and its levers are pushed

## LOCKING PRINCIPLE

This gun is locked securely at the moment of firing by a toggle joint. This is the principle developed by Hiram Maxim. The Vickers gun is a modification of the Maxim gun. This locking principle is used in Maxim guns throughout the world, notably in Germany and in Russia.

The simplest way to explain this principle is to compare it with the human knee.

**of the extractor face.**

During recoil the backward rotation of the crank moves the connecting rod and side lever head **upwards**. The side lever head bears on the tail of the tumbler and rotates it, thrusting the firing pin to the rear.

Further rotation of the tumbler in the lock completely withdraws the firing pin as the long arm of the lock spring bears against the projection of the pin. Thus the lock spring is compressed until the trigger nose, forced by the short arm of the lock spring, is pushed over the bent of the tumbler. The firing pin is withdrawn still further back until the sear spring forces the bent of the sear into the bent of the firing pin which thus holds it in cocked position.

It should be noted that in this weapon, part of the action attributable to backward movement is actually **to start some parts forward**. The crank handle continuing to roll against the roller during recoil movement, actually starts the recoiling portions forward while the lock is still moving backwards.

by the side levers: the gib is depressed against its spring, thus letting go its hold of the cartridge as the round is chambered and the gib is forced back into the face of the extractor.

The upper end of the extractor slips up around the rim of the cartridge in the feed block and the gib is pushed forward by its spring to grip the head of the cartridge to place it in proper position in the extractor when the next rearward motion of the lock will draw it out of the feed block. Springs located in the side plates engage in slots in the side of the extractor to hold it in its highest position to prevent it from falling should there be no cartridges left in the belt.

If the empty cartridge case has not dropped off the extractor face, it is ejected as the extractor rises during the forward movement by striking against the ejection feeding in the barrel casing.

When the lock approaches its fully forward position, its side lever head is forced slightly below the horizontal by the connection rod. It now depresses the sear, disengaging it from the firing pin, and allowing the firing pin to move forward slightly so that the trigger nose engages the bent in the tumbler.

If pressure on the thumb-piece is maintained for automatic fire, the trigger nose is held clear of the bent in the tumbler. The firing pin is free to spring forward under compression of the lock spring when the sear is depressed by the side lever head. However, it should be noted that the depression of the sear is so arranged that the firing pin cannot possibly be released until the lock is fully home and in firing position.

When in firing position, the lock on the Vickers gun fits securely against the firing chamber. Now picture the human foot with the heel held firmly in the position of this lock against the head of the cartridge. Pivoted to the lock is the connection rod, a heavy metal bar, thrust straight forward. This connection rod is like the lower part of the leg but can buckle **at the ankle** where it joins the foot. The crank is attached to the con-



# BRITISH VICKERS .303 MACHINE GUN

nection rod by a hinge pin and extends to the rear. This crank forms a bending knee where it joins the connection rod and itself resembles the upper part of the human leg now fully extended. However, the knee in this mechanical device is actually **below the line** of the connection rod and crank.

This crank is rigidly supported from below by the inside plates of the weapon and pressure applied to it by the side levers during the opening movement of the recoil, merely press the crank harder down on the plates.

Attached to the crank is a crank handle which travels back with it and after the gun has recoiled far enough to permit the bullet to leave the barrel, the tail on the

lower side of this handle is forced back in contact with a roller which causes the crank handle to rotate upwards. This raises the axis of the crank pin and permits the knee-like joint to buckle. (Thus, as the human foot is driven backwards, pressure applied to the underside of the knee will buckle the knee but draw the foot straight back.)

The connection rod is locked securely by a twisting motion inside the side lever head, which projects beyond the lower rear end of the lock. As the connection rod buckles, it naturally raises the side lever head with it, and this raises a tumbler which cocks the lock.

## FIELD STRIPPING

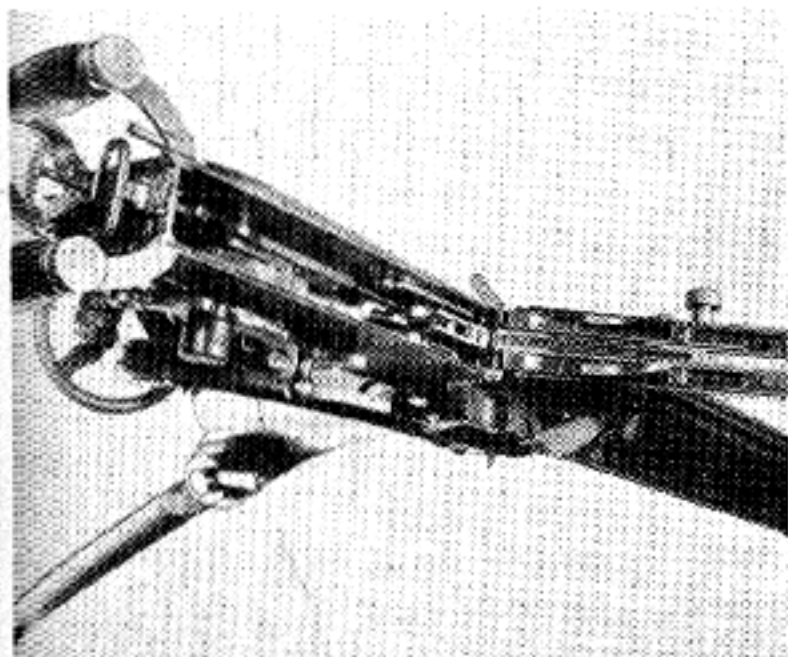

1. At the rear of the gun above the safety is the rear cover catch. It is held in place by a spring. Push up on the catch and raise the cover up as far as it will go.

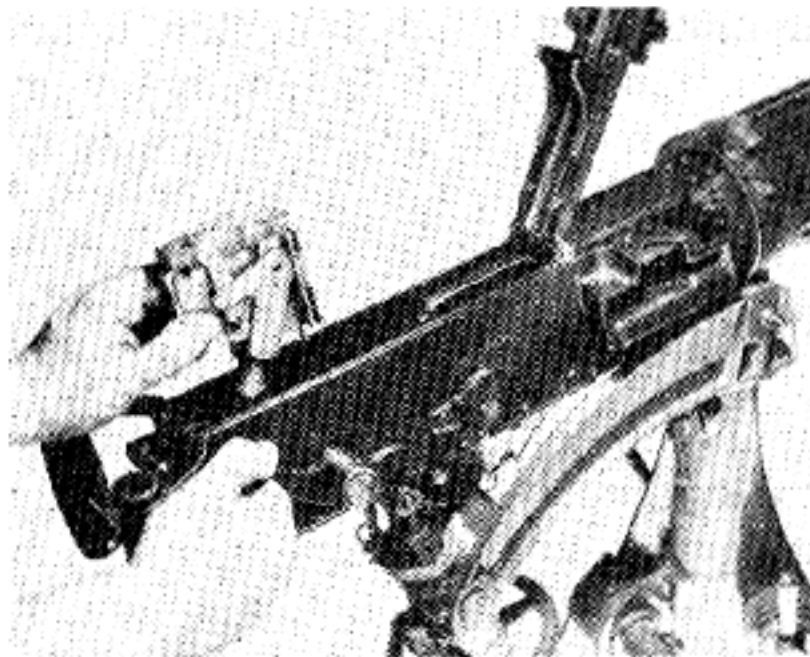

2. Now pull back the crank handle against the tension of the fusee spring. Hold it firmly. Reach inside the gun and lift out the lock which is fastened to the connection rod.

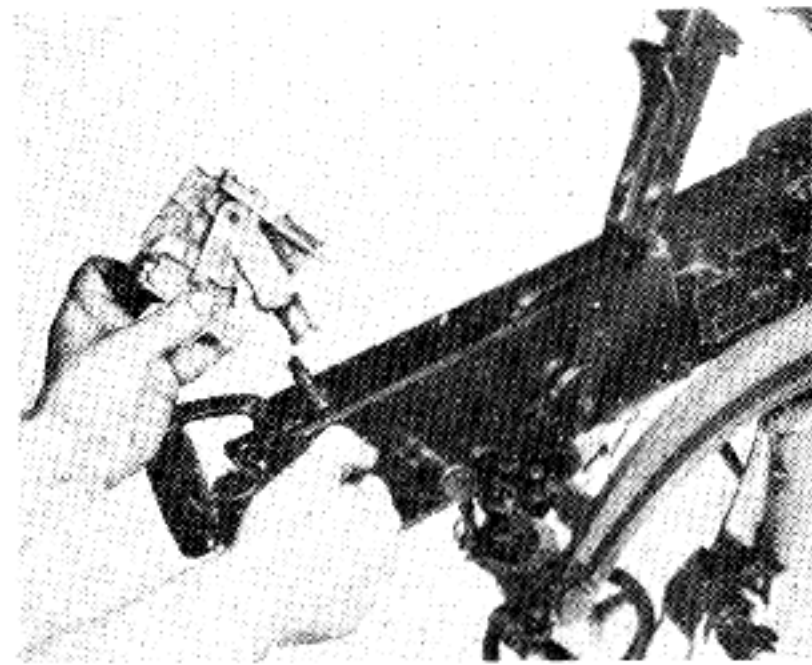

3. Now twist the lock on the connection rod about one-third of a turn to the right, to release it from the connection rod, which in its turn is connected to the crank. Lift the lock out, ease the crank handle home under the tension of the fusee spring. Then close the cover.

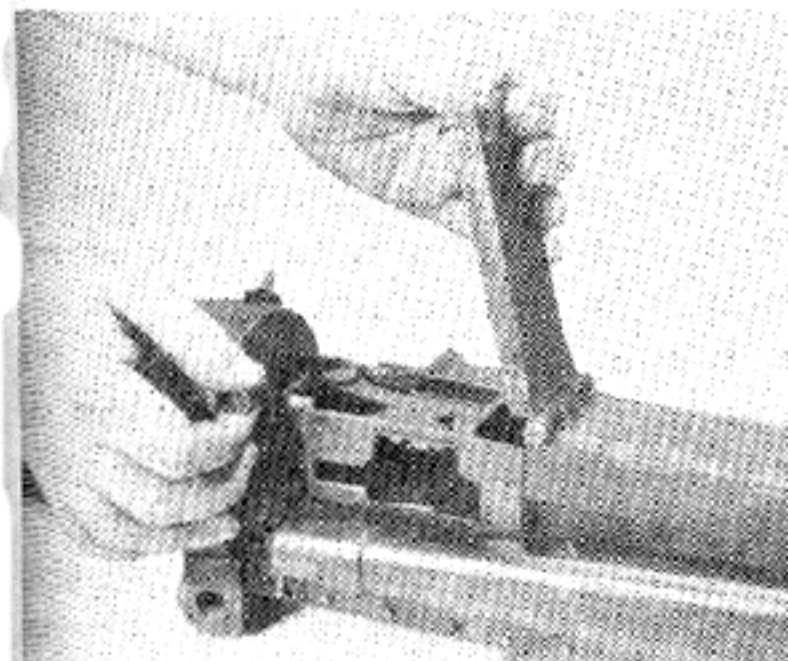

4. Turn the cover latch (on the forward end of the cover on the **left** side of the gun) up to the left as far as it will go. This releases the front cover which should now be raised as high as it will go.

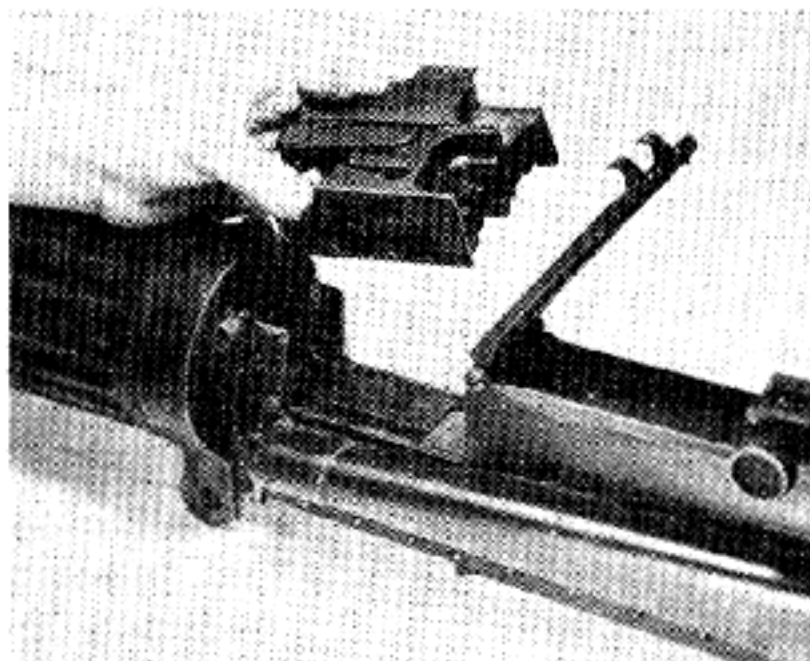

5. Now lift complete feed block directly up and out of the gun.

6. Go to the forward end of the gun. Pull out the split pin and twist the outer casing through about one sixth of a turn. It can now be pulled off to the front. The muzzle cup and the front cone may also be unscrewed and removed. (The gland and packing should be removed only if absolutely necessary.)

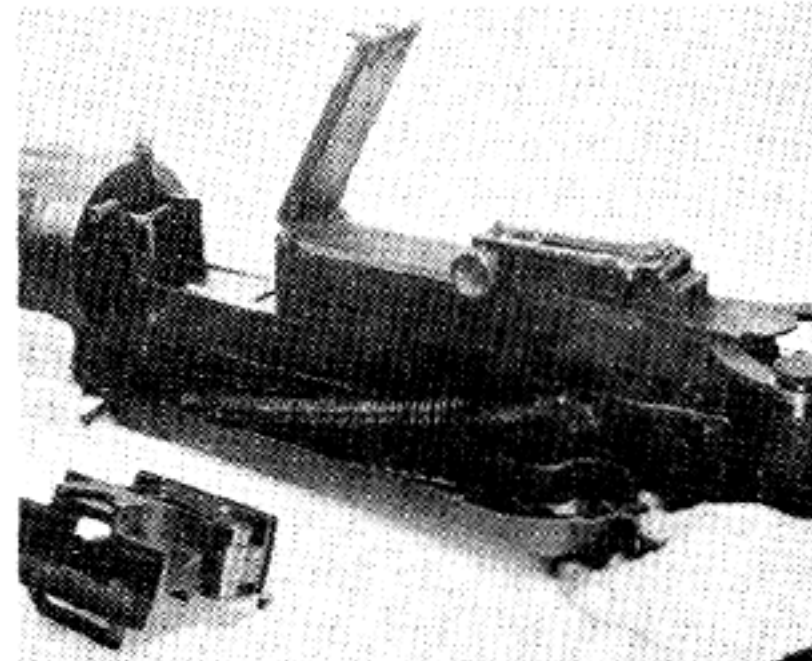

7. Grasping the front end of the spring box with the left hand, push forward on the **rear** end with the right hand until the hooks which fasten the box at front end and rear can be sprung out of their studs. Disconnect the box from the gun and unhook the fusee spring from the fusée. The fusee may now be turned until its lugs are free and then it can be withdrawn with its chain from the left.

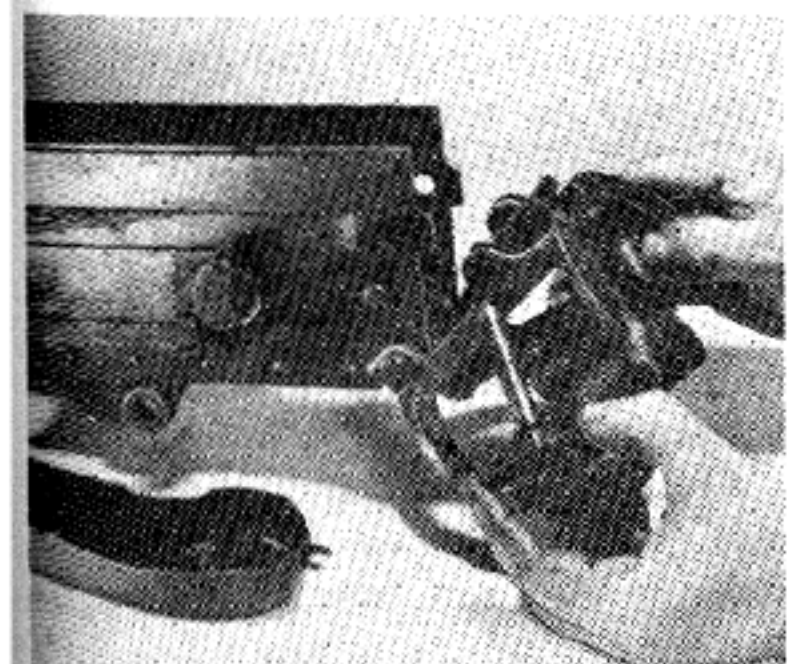

8. Now lift the rear cover and unscrew the large key pin protruding from the left side at the rear of the gun. Pull this pin out to the left, and it will permit the handles and their enclosed mechanism to be swung down to a horizontal position.

9. Slides which travel in the body at the rear may now be pulled straight out.

The right slide carries the roller with it.

10. Now pull the crank handle stem directly to the rear which will withdraw the crank, together with the right and left inside plates and the barrel.

11. Disconnect the right and left side plates from the crank and the barrel. This completes field stripping.



# BRITISH VICKERS .303 MACHINE GUN

## FURTHER NOTES ON STRIPPING

As this is one of the world's basic Machine Gun types, a more detailed explanation of stripping should be of value. An understanding of the Vickers, is particularly helpful in understanding all the German and Russian type Maxim Guns.

**Stripping the Lock:** 1. The lock is cocked as it comes out of the gun. Should it not be, due to having been snapped when withdrawn, it may be cocked by raising the side lever head.

2. A split pin with a bushing fastens the combined side lever head and side levers to the lock casing. Force these out. The side levers, and the extractor and extractor levers may now be removed.

3. The tumbler, the finger-like projection protruding from the locked casing just above the side lever, is fastened by an axis pin. Push this lever out and remove the tumbler. Now push down the tail of the sear which will release the lock spring.

4. Push out the trigger axis pin (the tip of the trigger protrudes from the top of the lock) and the trigger and lock spring may be removed.

5. Push downward on the sear and remove the firing pin and the sear and sear pin.

6. The gib may be removed by pushing out its spring cover and removing spring and gib.

**To Assemble the Lock:** 1. First insert the sear with spring downward, making sure that the sear jaws engage with the sear pivot.

2. Next insert the firing pin in its groove. Then replace the tumbler and fasten it with its tumbler axis pin.

3. Insert the trigger, fasten it by the trigger axis pin.

4. Replacing the gib and its spring and cover in position on the extractor, slide the assembled extractor **from the bottom up** in the guides in the locked casing.

5. Replace the extractor levers and side levers and fasten with the bushing and pin.

6. With sear held down by side lever head, pull back the trigger and press down the tumbler. Now insert the lock spring with its long arm facing **towards the extractor** and force it down and home.

The firing pin must be released **only** when the extractor is up **in the casing** as far as it will go; as only at this point is it lined up so that it will pass through the hole in the extractor. The pin will be injured if it strikes against a solid steel surface in the extractor.

**Stripping the Feed Block:** 1. The split pin holds the top and bottom block together and this must be forced out to permit separating the top and the bottom levers.

2. Pull out the slide with the top pawls and springs. They may be removed from the slide.

3. Now pull out the bottom pawl axis pin, which will permit removal of the bottom pawl and spring.

**Assembling the Feed Block:** Reverse the above procedure.

## ADJUSTING THE GUN

The most important adjustment on a machine gun of this type is the head space. This is the correct space between the head of the cartridge in the firing chamber and the face of the lock. **Should this space be too great**, the head of the cartridge will not be held firmly during the moment of high breech pressure. This may bulge the cartridge case so that extraction will be extremely hard, or it may rip the head completely off the cartridge case, resulting in an even more serious jam.

On the other hand, if there is insufficient head space, the lock cannot go forward completely and as a result the side lever head on the lock will not push the sear down far enough to permit the gun to fire.

**To Adjust Head Space:** 1. Remove the lock and the fusee spring.

2. Place crank handle in vertical position. Put the No. 1 washer on the outer face of the adjusting nut, making sure that the nut is tight. Now replace the lock in the **rear** position.

3. Reach up from below the breech and insert a dummy round or the correct armorer's gauge in the extractor over the firing pin hole, and raise the extractor to its highest point with the fingers. (Use a live cartridge only under suitable range conditions as this is a dangerous operation.)

4. Make sure that recoiling portions are all locked fully forward and guide the round or gauge into the firing chamber.

5. Rotate the crank handle forward while guiding the cartridge into the chamber.

6. Aside from the pressure necessary to compress the

sear, a slight check will be felt when the crank handle reaches the check lever if the connecting rod is **adjusted to the proper length** to give the correct test space.

7. **If no check is felt**, separate No. 1 or No. 2 washers should be added as required to the outer face of the adjusting nut to provide the correct length.

When the correct length has been ascertained, the washers are assembled permanently on the shoulder of the connecting rod and secured by its nut. (This is done by unscrewing and removing the nut with a combination tool, placing the washers on the connecting rod and replacing and screwing up the adjusting nut on the washer.)

Tests should be completed at this point to be sure that it has been done correctly, before completing assembly.

**Water Glands:** To prevent the cooling water from leaking out of the casing, glands are provided at the muzzle end and oiled asbestos packing wound in a cannellure cut around the breech end of the barrel.

If water leaks at the rear or breech end, empty the casing and then strip the weapon to remove the barrel. A piece of oil soaked asbestos string is then wound into the cannellure of the barrel; and pressed in with the point of a screw driver until the cannellure is full. Now oil this packing and smooth it down until it is flush with the barrel, then reassemble the weapon.

Should water leak at the muzzle, stand the gun up on its traversing handles and remove the muzzle attachment together with the cup and unscrew the muzzle gland.



# BRITISH VICKERS .303 MACHINE GUN

Remove the asbestos string packing, reoil it and wind it loosely around the barrel, pushing it in with a punch and piece of wood. Then screw the gland on as tightly as possible by hand.

This should stop the leakage and yet permit the re-coiling portions to move freely.

**Cooling System:** Whenever it is at all possible the barrel casing should be kept full during the firing period. The water will boil after firing two belts. It evaporates at the rate of one and a half pints for every 500 rounds, or two belts, if fired continuously. If 2000 rounds are fired, casing will require refilling.

**Weighing the Recoiling Portion:** Remove the fusee spring and put the crank handle in almost vertical position. Now place the loop of the spring balance on the crank shaft and draw it slowly to the rear. The weight should not exceed 4 lbs. If more than 4 lbs. is required to remove the recoiling portions, it indicates

that the packing is pressing too hard on the barrel and the gland must be removed and one or two strands taken out of the asbestos.

**To Check Weight of Fusee Spring:** 1. Remove the lock and place the loop of the spring balance over the top of the crank handle. Stand to the left of the gun and press down the check lever with the left hand; and with the right pull the balance vertically upwards. When the crank handle begins to move, the weight should be between 7 and 9 lbs.

If necessary to adjust it, wind the vice pin at the forward end of the fusee spring box on the left side of the gun. Six clicks turning from right to left **increases** the weight one pound; while six clicks turning from left to right **decreases** the weight one pound.

Improper adjustment of the fusee spring will jam the weapon.

## SPECIAL NOTE ON VICKERS GUN

During World War I, many factories in the United States were manufacturing Vickers Guns for the British Government when the United States entered the war. Some of this machinery was adapted to producing Vickers Guns to shoot the standard United States Army ammunition. The intention was to use the Vickers as a supplemental United States Service weapon because the Browning could not be manufactured in sufficiently large quantities to fill the need during that emergency.

Since that time the Browning model 1917 has become the standard Service weapon of this class in our service. Large stores of these guns in caliber .30 U. S. as well as the standard British .303 were sold or lease-lent to

Great Britain during the present crisis. As a result, Vickers Guns are in use in Great Britain and throughout the world, China and many nations (including the Japanese) have stores of these guns purchased from English manufacturers before the War. The British paint all the .30 U. S. (or as they term them .300) Caliber Guns with a 2" band of red paint across the front body cover; while the mouth of the feed block and the side lever head are also painted red. This is done to prevent confusing the non-interchangeable parts with the .303 British issue.

**Special Note:** The Japanese have imitated and are using this gun quite extensively.



# BRITISH HOTCHKISS .303 LIGHT MACHINE GUN

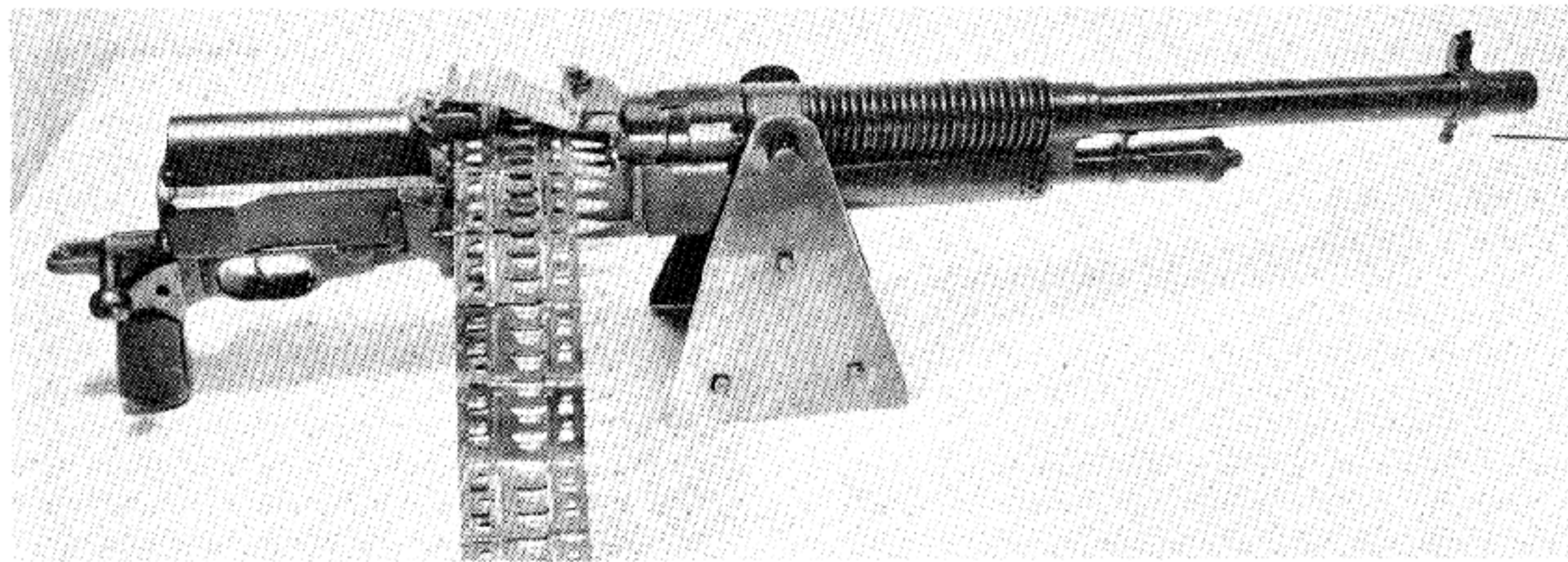

The model illustrated is the Mark I\* without shoulder stock intended for tank use. Identical in all other ways with the typical Infantry and Cavalry model.

**Caliber:** .303 British Service cartridges.

**Method of Feed:** Mark I models, use tempered metal strips holding 9, 14 or 30 cartridges. This model will not use a belt.

**Model Mark I\*:** This model will take the metal strips as in the Mark I or will take a metal link belt holding 50 rounds. This belt is in strip form.

**Ballistics of Cartridge:** Standard for British Service .303.

**Barrel Length:** 23 $\frac{1}{4}$ ".

**Overall Length with Attached Butt Stock:** 3' 10 $\frac{1}{2}$ ".

**Weight:** Approximately 27 lbs. with butt, but without mounting.

**Weight of Loaded 30 Round Strip:** 1 lb. 15 ozs.

**Weight of Loaded 50 Round Belt:** 3 lbs. 3 $\frac{1}{2}$  ozs.

**Accurate Range:** About 500 yards.

**Gun Operated by:** Gas, escaping through a small hole bored in the barrel as the bullet passes over it into a cupped piston head fitting over a gas nozzle; the gas drives back the piston to work the action. A spiral recoil spring is compressed as the action is forced rearward, storing energy for the return motion.

**Locked:** By interrupted screw. Two parts of the mechanism (the breech block and the fermeture nut) furnish the locking arrangement. The fermeture nut which is rigidly supported in the body bears **female** threads; while the breech block, which enters it, bears **male** threads. A portion of each thread is removed, so that the breech block can slide into the fermeture nut, and then by a partial turn of the fermeture nut, the two can be securely locked. This necessary partial rotation is caused by the action of an inclined groove on the rearward moving system working on a stud.

**Cooled:** Has extra heavy barrel with radiator rings. Barrel is changeable.

**Sights:** Barleycorn front sights, V notch rear sight adjustable to 1000 yds.

**Cyclic Rate of Fire:** About 550 shots per minute.

**Position of Cocking Handle:** Extends back over pistol grip coming out of the lower rear end of the receiver. Must be turned up to the left before it can be pulled back.

**Type of Fire:** Single shot or full auto. (a) Turning handle up and pulling it to the rear as far as it will go cocks the weapon. Then the cocking handle is thrust forward. When it is fully home, it may be turned over **to the right** and lined up with lines engraved directly in front of it as follows: (1) "A" for full automatic fire (2) "R" for repetition or rounds, single shot fire (3) and "S" for safe, in which position the weapon cannot be fired.

**Gas Regulator:** This is positioned at the extreme front end of the gas cylinder. Screwing in this regulator increases the amount of gas and unscrewing it diminishes the amount. The normal setting for the regulator is between 15 and 25 on the indicator. Start testing at 25 and work down or up as the functioning of the gun seems to require.

**Feeds:** From the right side.

**Ejects:** From the left side.

**Position of Breech or Bolt on Cease Fire:** Open. This gun fires from an open bolt and so the action cannot be eased forward while there is a strip in the gun.

**Mounts:** A small tripod mount is normally supplied with this machine gun. The weapon may be handled by one man. However, if there is a second one to load, it is possible to achieve at least 400 delivered rounds per minute. This is a very flexible gun and is designed to be fired primarily from a lying position; the weapon being rested on ammunition boxes, hand bags, tree limbs or other rests or covers.

## LOADING AND FIRING

1. **The Feed Strips:** The strip normally used will hold 30 rounds. It is stamped from a single piece of sheet steel and spring tempered to give elasticity to the clip. Three rows of these clips stretch along the strip; holding the cartridge near the rim, over the powder space and near the bullet neck. A stop lug behind the head of the cartridge case prevents it moving upwards. If a filler is available, the hopper should be filled with cartridges and feed strip fed into its guides on the machine with stop

lugs to the rear until the feed tooth catches behind the first middle clip; when a turn of the crank will push the cartridge forward into the clip and feed ahead for the next cartridge.

2. To fill by hand, force each cartridge between the clip until the rear face of the head of the cartridge rests against the front of the continuous rib on the rear edge of the strip (or against the small nib rising in the same position on the belt). Care must be taken that the rims



# BRITISH HOTCHKISS .303 LIGHT MACHINE GUN

of all cartridges seat back against the stop lug and are all in line and correctly positioned.

**Note:** If the gun will take a belt as well as a strip, the words "Belt or Strip Feed" will be found stamped on the rear sight.

**Belt Feeding:** If the belt is used on the ground model, a belt carrier is used normally to hold it in position at the mouth of the feed opening. This carrier consists of a cradle, a pan which can be swung vertically out of the way when loading, and a clamp fixed to the gun by side plates, nuts and bolts.

## PREPARING TO FIRE

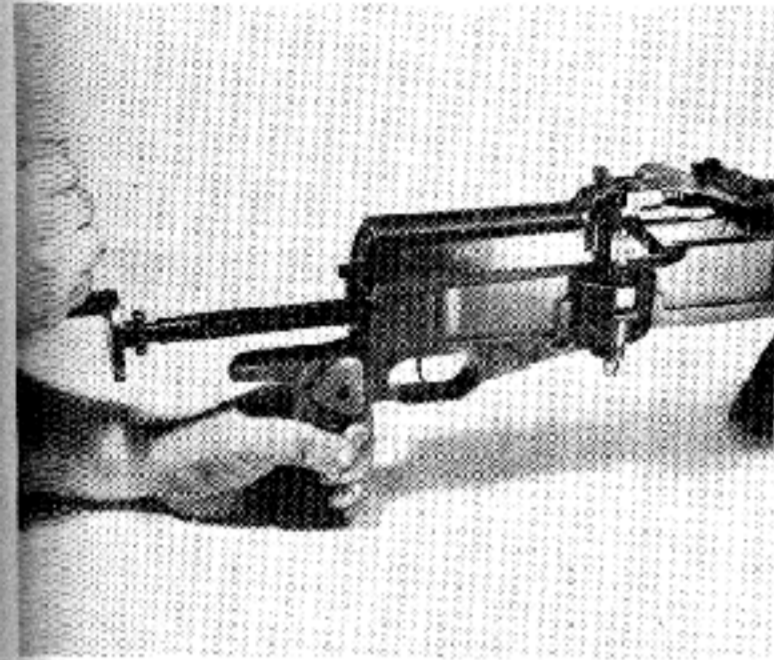

1. Cock the gun. In the type illustrated the pistol grip is held with the left hand, while the cocking handle is turned up as far to the left as it will go and pulled back to its limits, which is about 6". (If the gun has the regular type butt, the butt may be held against the shoulder with the butt-strap over the shoulder and both hands used if necessary to pull back the cocking handle when it has been turned up out of its locking position). This action does not merely cock the weapon, it actually draws the moving parts to the rear of the cocked position and the piston is held up by the lower arm of the feed piece.

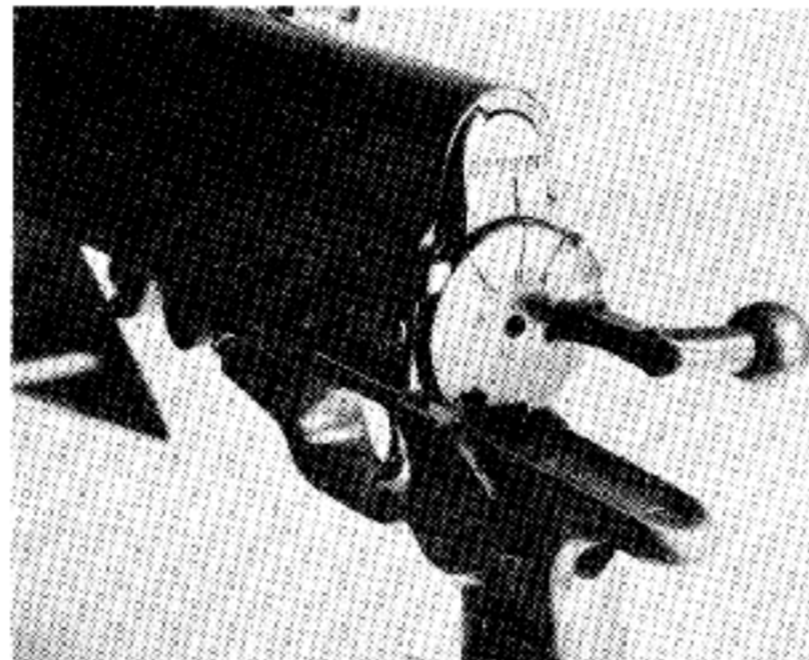

2. Thrust the cocking handle forward keeping it slightly to the left of the vertical and when it is firmly seated, turn the lever over towards the right. Turn it until the letter indicating the action which you wish to produce is lined up with the line on the body directly above it. "A" for full automatic fire; "R" for single shot fire and "S" to lock the weapon and apply the safety.

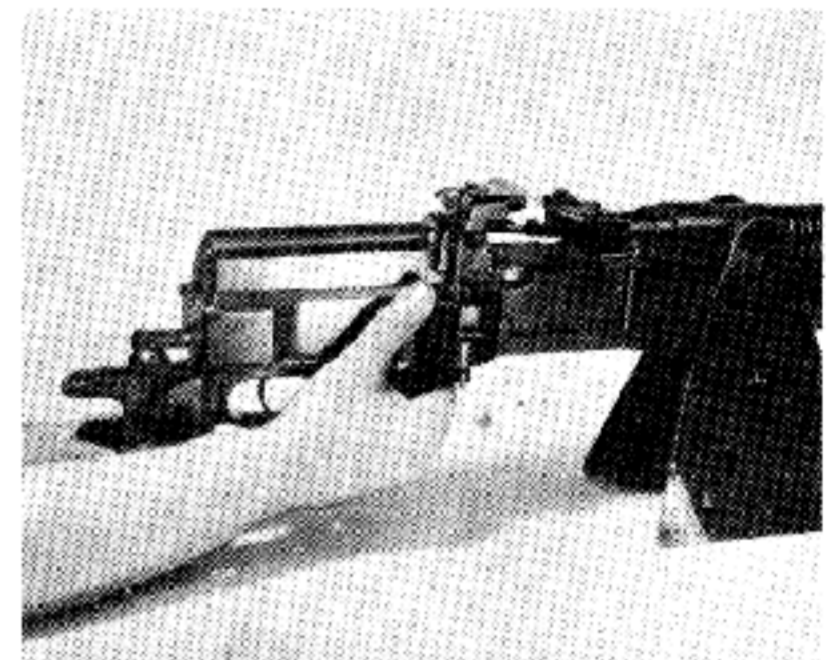

3. Push up the stem protruding from the right side of the gun just ahead of the trigger guard and under the feed piece. (This requires considerable pressure.) Use the second joint of the forefinger and put the entire pressure of the hand behind it. This lifts the feed piece out of engagement with the piston. The heavy moving parts will go forward a short distance under the pressure of the return spring, stopping when the weapon is fully cocked on the bent of the piston and the sear.

4. **To Load the Gun: If strip is used:** Feeding the flat end first, and **with the strip on top of the cartridge**, push the strip into the feed opening on the right side of the gun. Again lift the feed piece as high as it will go, and push strip until the pawl which forms part of the feed spring engages with it. This will prevent any backward movement of the strip. The weapon is now ready to fire.

**If belt is used:** Unfasten the spring catch of the cradle and allow the holding pan to fall away. Pass the first unit of the coiled belt, which contains 6 rounds, through the broad slot in the cradle in the feed opening. Now close up the pan until its catch engages and place the

coiled belt in the pan. Push up the stem of the feed piece from below as far as it will go; and push belt home until the two pawls engage in the first slot on the near side. **Note:** Belts are made up in units, the usual pattern consisting of 16 units, the first one containing 6 rounds in the strip, the next 14 holding 3 rounds each and the last one holding 2.

5. As the last cartridge is fired, the empty strip is ejected from the left side of the gun. The feed piece, which has been held up by the strip, is now pushed down by its spring and holds the breech open. It is now ready for the insertion of another strip.

## FIELD STRIPPING

1. Make sure that the action is fully forward and the breech closed. Then turn the cocking handle up to the left as far as it will go. Next draw the cocking handle back about  $\frac{1}{2}$ ", then turn it down to the right about  $45^\circ$ . This will clear the cocking handle from the piston. Now pull out the cocking handle straight to the rear.

2. At the extreme left side of the receiver is a locking screw with a lever attached. Unscrew this three turns. Then holding the receiver firmly with the left hand, grasp the pistol grip with the right. Push the grip about  $\frac{3}{8}$ " straight ahead and then pull it straight down which will separate it from the receiver. The sear, sear spring and trigger remain with the trigger guard.

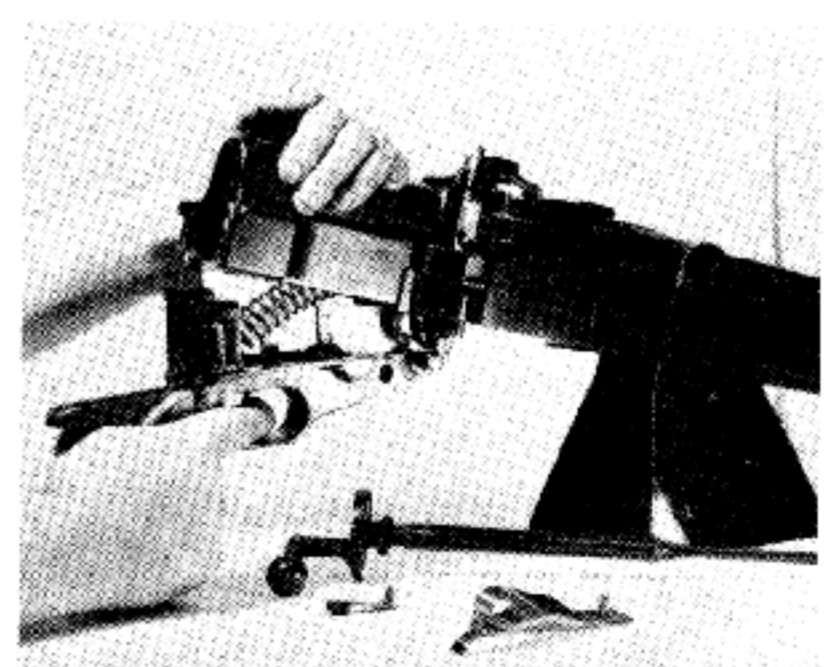



# BRITISH HOTCHKISS .303 LIGHT MACHINE GUN

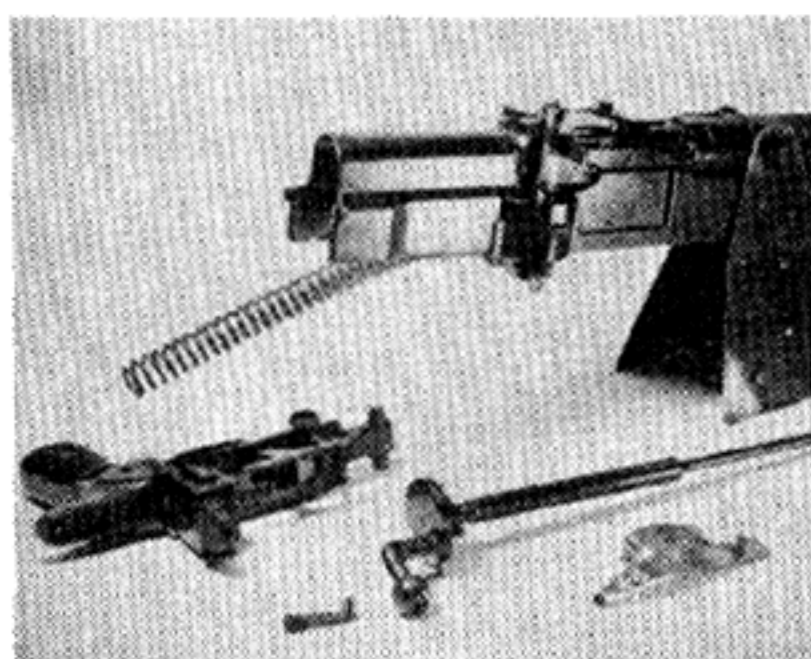

3. Now withdraw the recoil spring from the receiver.

4. Insert the cocking handle in the piston and push forward as far as it will go, keeping the knob inclined to about 45°

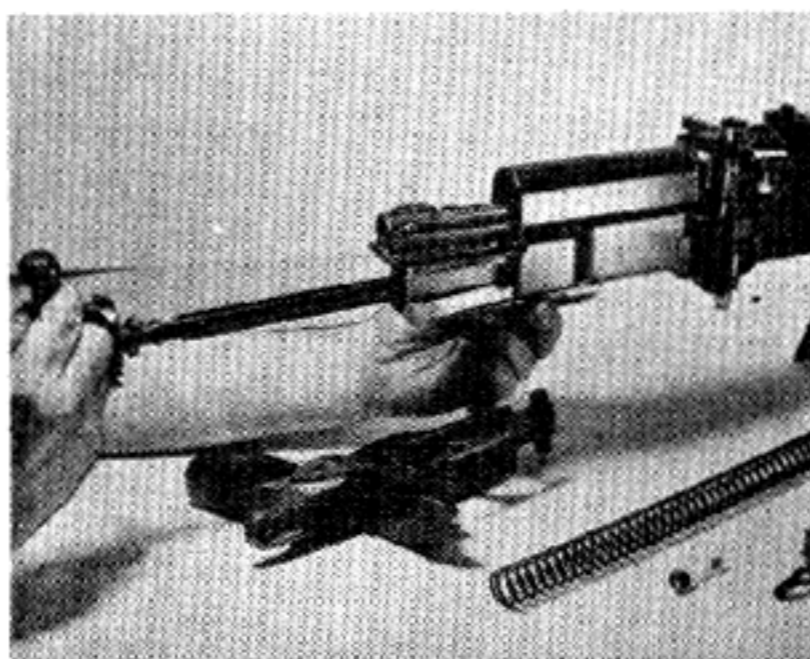

to the right as when dismounting. When it is fully home, turn the knob up to the vertical position which will engage the lugs at the forward end of the piston. Pulling the cocking handle straight back



now will bring the piston, breech block, extractor and firing pin completely out of the gun.

5. Remove the cocking handle from the piston, and lift the breech block out of the piston.



6. Firing pin and extractor may now be removed from the breech block. Note the interrupted threads at the forward end of the bolt, or breech block, which when revolved into the fermeture nut lock the weapon securely.

7. The feed spring is held by a button

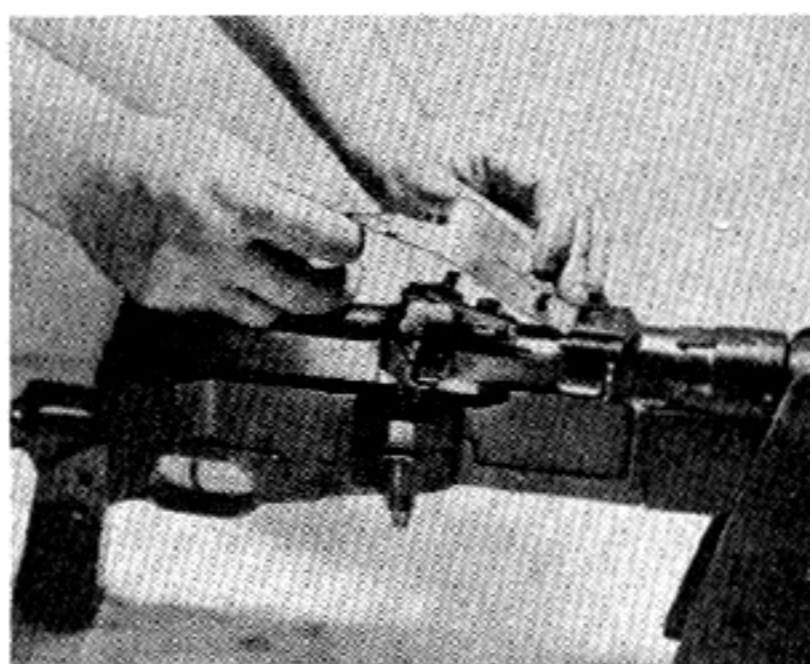

at the top of the feed piece. Disengage this by bringing it up by means of the hooked portion which projects to the rear. Remove it.

8. Remove the feed piece. Lift the leaf of the rear sight; and throw open the feed piece cover by pulling out the



knurled knob. Then lift the feed piece to its highest position, turn to an angle of 180° so that the lever is pointing to the rear. As the flattened portion is now opposite the corresponding slot, in the upper bearing, the feed piece may be lifted out.

**Note:** The only other dismounting necessary or recommended for this weapon is barrel removal for replacement when barrel becomes too hot when being fired.

9. Using the dismounting wrench, unscrew the barrel locking nut (this is directly behind the radiator surface of the barrel near the receiver) about 1/6th of a turn to the right with the right hand. The barrel may now be drawn straight to

the front out of the receiver.

10. A stud holds the hand guard in place while the barrel is being mounted or dismantled; by turning the locking nut to the left, it can be freed of engagement with the hand guard. The hand guard

(which lies directly below the barrel) may thus be removed by drawing it straight to the front.

11. The locking nut may now be unscrewed and removed and the fermeture nut removed.

## NOTE ON ASSEMBLY

Mount the fermeture nut, barrel nut, hand guard, barrel, ejector, spring and cap, feed piece and feed piece spring **in that order**. Remember that the fermeture nut must be placed with **flat end to the front**, and that locking nut is ready for assembly of hand guard and barrel when its claw has passed over the serrated stud **only once**.

Assemble trigger, sear and sear spring (if they have been dismantled) and mount them in the guard.

See that the round stud on the barrel locking nut clears the hand guard and is then turned down to receive the barrel.

Before the breech block and piston are inserted in the receiver, **be sure the fermeture nut in the receiver is turned to its open position**. You may check this by inserting the forefinger through the ejection opening.

When the slot in the nut and the ejection opening coincide, the nut is in the proper position. Also note that before the breech block will enter the receiver, the firing pin **must be turned over to the left**.

Now press up the lower end of the sear piece with the right hand to bring it to its highest position so that the piston will not hang up on it, and push the piston forward with the left hand until the breech is completely closed.

Now insert the recoil spring in the piston, and push it forward, permitting a few inches to project to the rear of the receiver.

Next engage the projecting end of the recoil spring in its seat in the trigger guard and bring the guard to a position under the receiver where the two lugs on its head are opposite their mortises in the receiver. The



# BRITISH HOTCHKISS .303 LIGHT MACHINE GUN

trunnions at the front will be below and in advance of the sockets in the bottom of the receiver. The cocking handle shank may be inserted to keep the recoil spring engaged in its seat in the trigger guard.

Then engage the lugs in their proper mortises and the trunnions in their sockets by raising the trigger guard **straight up**; and drawing it to the rear until it is solidly

## HOW THE BRITISH 303 HOTCHKISS WORKS

**Starting with the gun cocked and the strip properly loaded into the feed guides, the action is as follows:** When the trigger is pressed, the sear nose is pulled out of its bent in the piston and the compressed recoil spring pushes the piston on which is mounted the breech block, directly ahead in the receiver. The breech block pushes a cartridge from the feed strip, directly into the

### RETURN MOVEMENT OF THE ACTION

The bullet goes down the barrel and passes over the port which leads to the gas nozzle, and a small portion of gas under high pressure is conducted by the port and the gas nozzle to strike a sharp blow against the cup shaped forward end of the piston, driving it sharply to the rear. As the piston goes back it compresses the recoil spring behind it.

Also as the piston goes back, the cams on its upper face **twist the fermeture nut** through a partial revolution which unlocks its uninterrupted threads from the corresponding threads on the nose of the breech block. The breech pressure falls to safe limits as the breech is thus unlocked. The feed piece, under the action of its spring catches the shoulder on the piston, locking it in the rear-most position.

As the breech block is withdrawn, the attached extractor draws back the spent cartridge case, strikes it against the ejector which hurls it out the left side of the gun.

As the backward stroke of the piston nears its end, a

## SPECIAL NOTE ON THE BRITISH HOTCHKISS

When two men are operating this gun, the barrel may be changed in about 15 seconds; as no dismounting of any other part of the weapon is necessary.

The gunner unscrews the locking nut a sixth of a turn with the right hand using the dismounting wrench, while the second gunner or assistant grasps the legs of the barrel rest close to the barrel. The gunner pulls straight to the rear on the receiver, separating it from the barrel. Holding the hot barrel by the barrel rest, No. 2 now turns the legs forward until they are in line with the barrel, then pivots the legs half a turn around the lug of the front sight carrier and lifts it off the hot barrel.

seated in the receiver, screw up the locking screw on the left side of the receiver.

With the shank of the cocking handle in its opening in the guard, with knob inclined 45° to the right, push forward to a stop. Turn the knob completely to the left to a stop. Then push the cocking handle forward as far as it will go and turn the knob to the right down as far as it will go.

chamber; and cams on the upper face of the piston **gives a turning motion** to the fermeture nut which thereby engages its interrupted threads with the corresponding ones on the nose of the breech block. This securely locks the breech during the period of high pressure. The firing pin is driven against the primer and the cartridge is discharged.

cam on its side gives a rotary movement to the feed piece which draws the feed strip sufficiently into the guide to bring the next cartridge into the loading position.

When the last cartridge is fired, this action hurls the exhausted strip out of the gun. The feed piece, which has been held up by the strip, is now forced down by its spring, engaging with the shoulder of the piston and **locking the breech open**.

When the weapon is set at "A" (automatic fire) the piston is free to move forward again under the action of the recoil spring and fire continuously as long as the trigger is held back and there are any cartridges in the strip. When set at "R" (single shot fire) the sear engages with the piston each time the piston recoils, thus only one shot will be fired for each pressure of the trigger. Setting the indicator at "S" locks the trigger securely so that it cannot be pulled back nor the sear released from the piston.

The new barrel is slid into place and locked, and the barrel rests attached and reset.

The British Hotchkiss is not to be confused with the French Hotchkiss from which it was developed. It uses the original Hotchkiss principle of direct operation by gas; and there are similarities in feed. The locking principle is quite different, however. Furthermore, the purposes of the two guns are entirely different. The British Hotchkiss was originally designed to fill the need for a sturdy cavalry weapon of this class, though it is also used by infantry and tank units.



# BRITISH STEN 9-MM SUBMACHINE GUN MARK I, II AND III

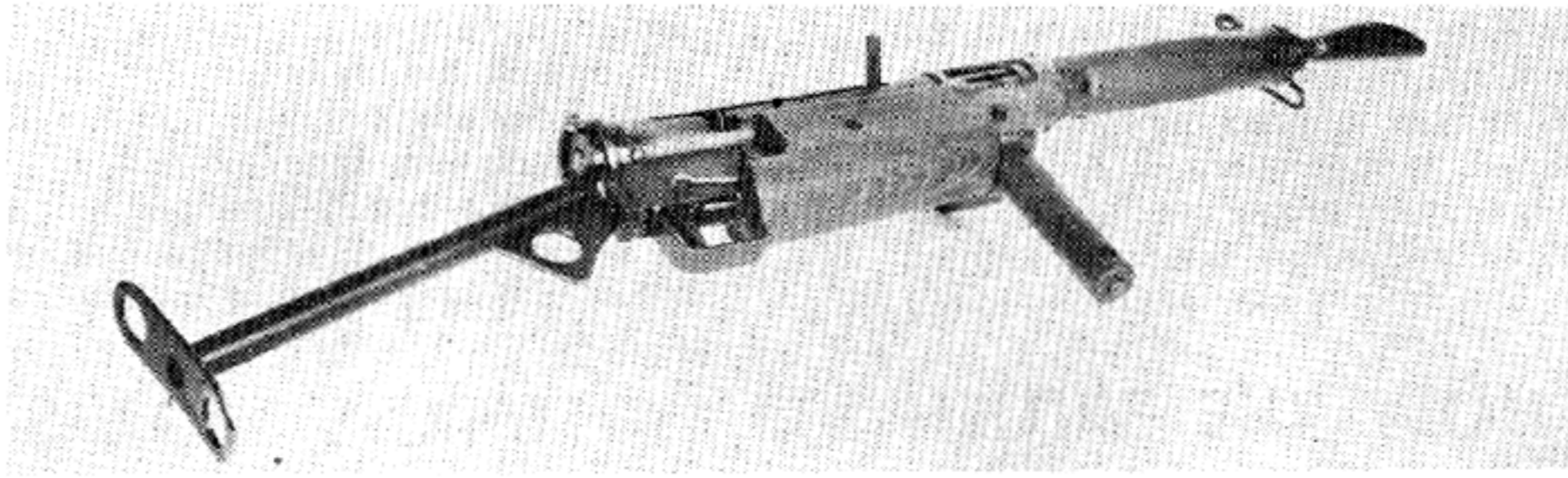

**MODEL MARK I**

**Caliber:** 9mm Parabellum (.35).  
**Magazine:** Staggered box type, capacity 32-cartridges.  
**Weight of Bullet:** About 125 grains, round nose with metal jacket.  
**Muzzle Velocity:** About 1060-feet per second.  
**Muzzle Energy:** About 300 foot pounds.  
**Overall Length of Carbine:** 35 inches.  
**Weight without Magazine:** 8 lbs.  
**Weight of Loaded Magazine:** 1½ lbs.  
**Front Sight:** "Barleycorn"—common European type like an inverted V.  
**Rear Sight:** Fixed aperture, set for 100 yard range.  
**Accurate Range:** About 200 yards.  
**Gun Operated by:** Backward pressure of gases against fired cartridge case.

**Locked:** Simple blow-back. Heavy bolt and return spring delay opening of breech until bullet has left barrel.  
**Cooled:** Air. Bolt stays open between shots and air enters through open ejection port.  
**Cyclic Rate of Fire:** 500 to 550 per minute.  
**Position of Cocking Handle:** Right hand side of carbine, to rear of ejection port.  
**Type of Fire:** Selective. Single shot per trigger squeeze or full automatic.  
**Safety:** When cocking handle is pulled back almost to end of slot, it can be turned **down** into lock slot.  
**Note:** It is dangerous to carry this weapon with a loaded magazine inserted and the cocking handle in forward position, as a jar may fire it.

## MODEL MARK II

**Overall Length of Carbine:** 30 inches.  
**Weight without Magazine:** 6¾ lbs.  
All other data same as for Mark I.

View showing  
gun uncocked, bolt handle forward.

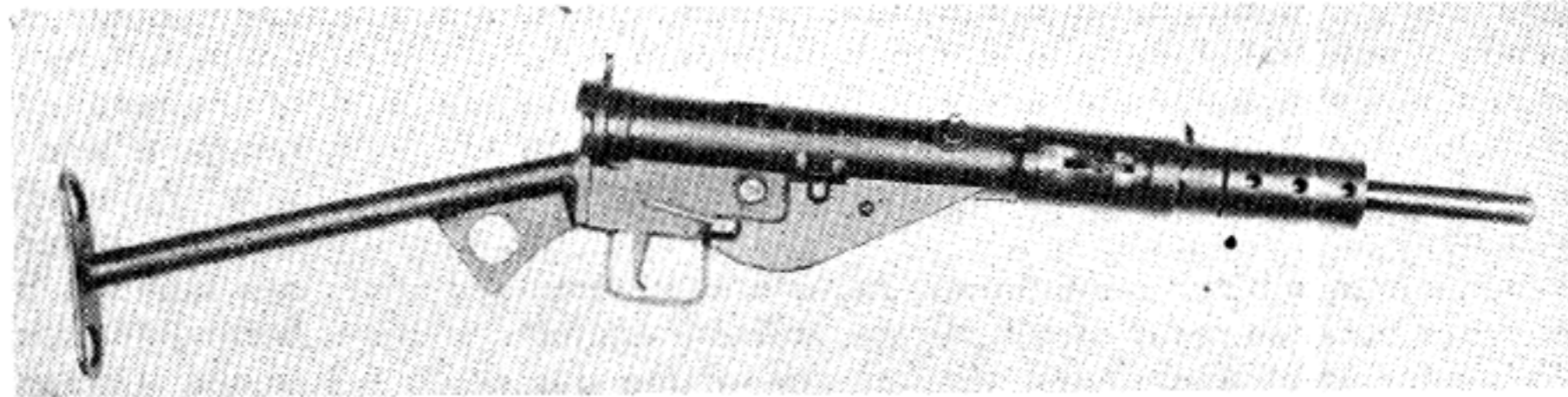

## MODEL MARK III

**Overall Length of Carbine:** 30 inches.  
**Weight without Magazine:** 6 lbs. 6 oz  
All other data same as for Mark I.

View showing  
gun cocked, ready to fire.



View showing  
magazine, catch, and housing.

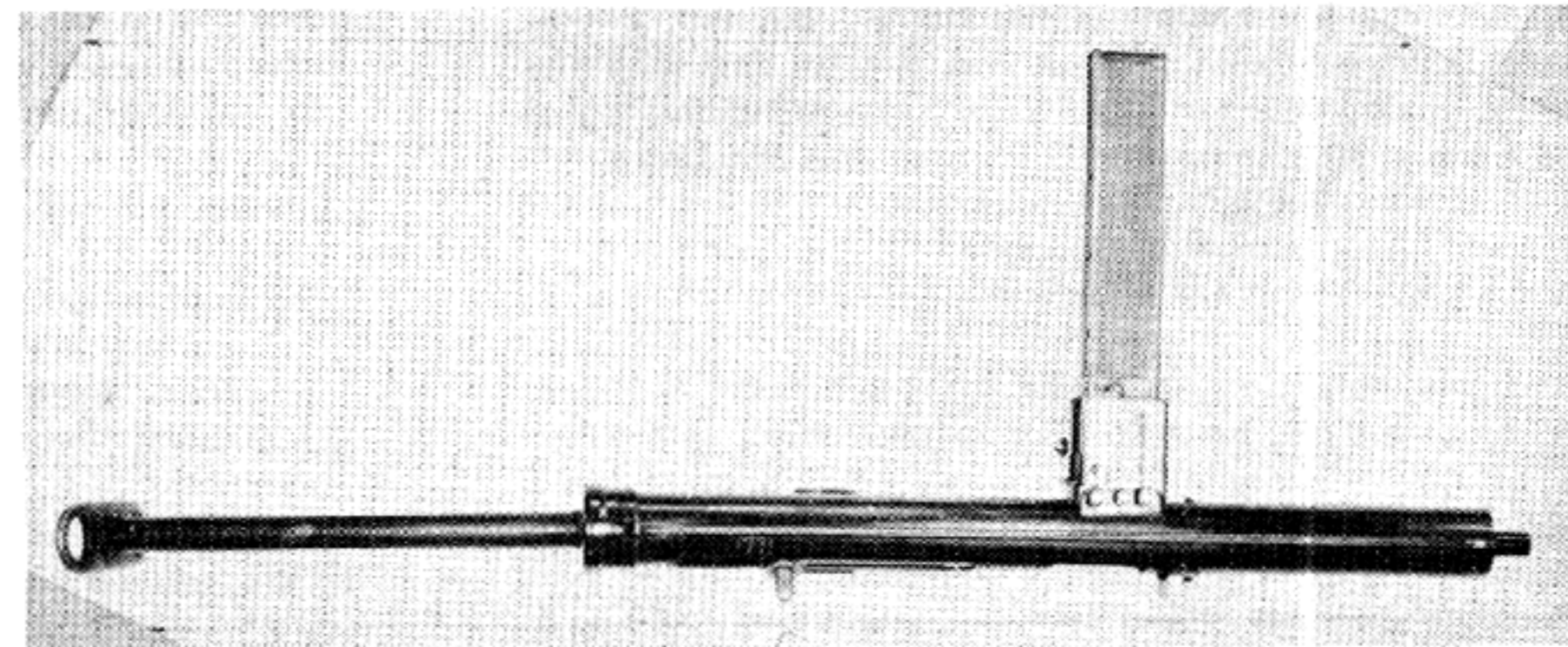



# BRITISH STEN 9-MM SUBMACHINE GUN MARK I, II AND III

## INSTRUCTIONS FOR LOADING AND FIRING

1. Insert loaded magazine, bullets pointing forward, into magazine housing on left side of carbine just ahead of forward end of cocking handle slot. Push in until magazine locks with a click.

2. Pull back cocking handle and turn down into safety slot if the model is Mark I. (If model is Mark II or III, the safety slot is up—so turn cocking handle **up** into slot.)

3. When ready to fire, turn cocking handle out of the safety slot.

4. Directly under the safety slot is a button passing

through the carbine from side to side. (a) If you wish to fire one shot with each pull of the trigger, push the button from the **left side**. (It is marked "R," meaning "Repetition.") (b) If you wish to fire full automatic, push the button through on the **right side** of the carbine, where it is marked "A," meaning "Automatic."

**Note: To remove magazine:** This is done by pressing down with the left thumb on the magazine catch (which is at the rear of the magazine housing), and at the same time grasping and pulling the magazine out with the fingers of the left hand.

## NOTE ON AMMUNITION FOR USE IN STEN GUNS

These guns were deliberately designed to use captured enemy ammunition. They will take any standard cartridges issued by the Germans for use in their official Luger and Walther Pistols (called the P. '08 and P. 38, respectively) as well as more powerful cartridges **of the same overall length** issued for use in the Schmeisser, Solothurn, Bergmann, Erma, Neuhausen and similar sub-machine guns. They will also take the less powerful Italian cartridges issued for use in the Glisenti Pistol and the Beretta submachine gun. British ammunition manufactured for the weapons is not as powerful as its United States counterpart, which will usually be called 9mm Luger.

In general the Sten will handle any 9mm ammunition

whose overall length is between 1.14 and 1.16 inch. It will not handle short 9mm ammunition of the Browning or Beretta type, nor will its magazine handle extra length cartridges of the 9mm Mauser, Steyr or Bayard Long types.

Muzzle velocity may be anywhere from 950 to 1500 feet per second, the lower figure being for cartridges of Italian manufacture and the higher for special black bullet ammunition issued by the Germans for some types of submachine gun use. The U. S. 9mm Luger cartridges vary in M.V. from about 1050 to 1200 f.p.s.

The 9mm Parabellum is the most universally used pistol and submachine gun cartridge. It is manufactured and used throughout the British Empire.

## HOW THE STEN GUN WORKS

A loaded magazine being inserted in the magazine housing until it locks, the cocking handle is then pulled back to the cocked position, compressing the return spring.

When the trigger is pressed, the heavy breech block is freed and driven forward by the return spring. Feed ribs on the breech block strip the top cartridge from between the lips of the magazine and drive it into the firing chamber. The extractor, which is attached to the breech block, snaps into the cannellure in the cartridge case and the firing pin strikes the cartridge primer exploding the powder.

The inertia of the heavy breech block and spring in forward motion keeps the breech closed until the bullet has left the barrel and the breech pressure has dropped to safe limits.

The remaining pressure drives the empty cartridge case and moving parts to the rear. The case strikes against the ejector and is hurled out of the gun. The

magazine spring pushes the next cartridge in line for feeding.

**Note:** Because of the simplicity of its construction and its working principle, the Sten needs very little oiling and very little attention. Unlike many of the more expensive submachine weapons, it is not encumbered with trick and unnecessary locking devices which occasion stoppages.

Stoppages are likely to be due almost entirely to deformed magazines, which should be changed at the first sign of trouble.

This gun will do practically anything that the expensive ones will do, though its cost runs only from \$10.00 to \$20.00 to manufacture—the cost being determined by the place of manufacture. (It is now being made in tremendous quantities in Great Britain, Canada, Australia and New Zealand.)

The Sten is being widely used by parachute troops and by the British Home Guards.



# BRITISH STEN 9-MM SUBMACHINE GUN MARK I, II AND III

## FIELD STRIPPING

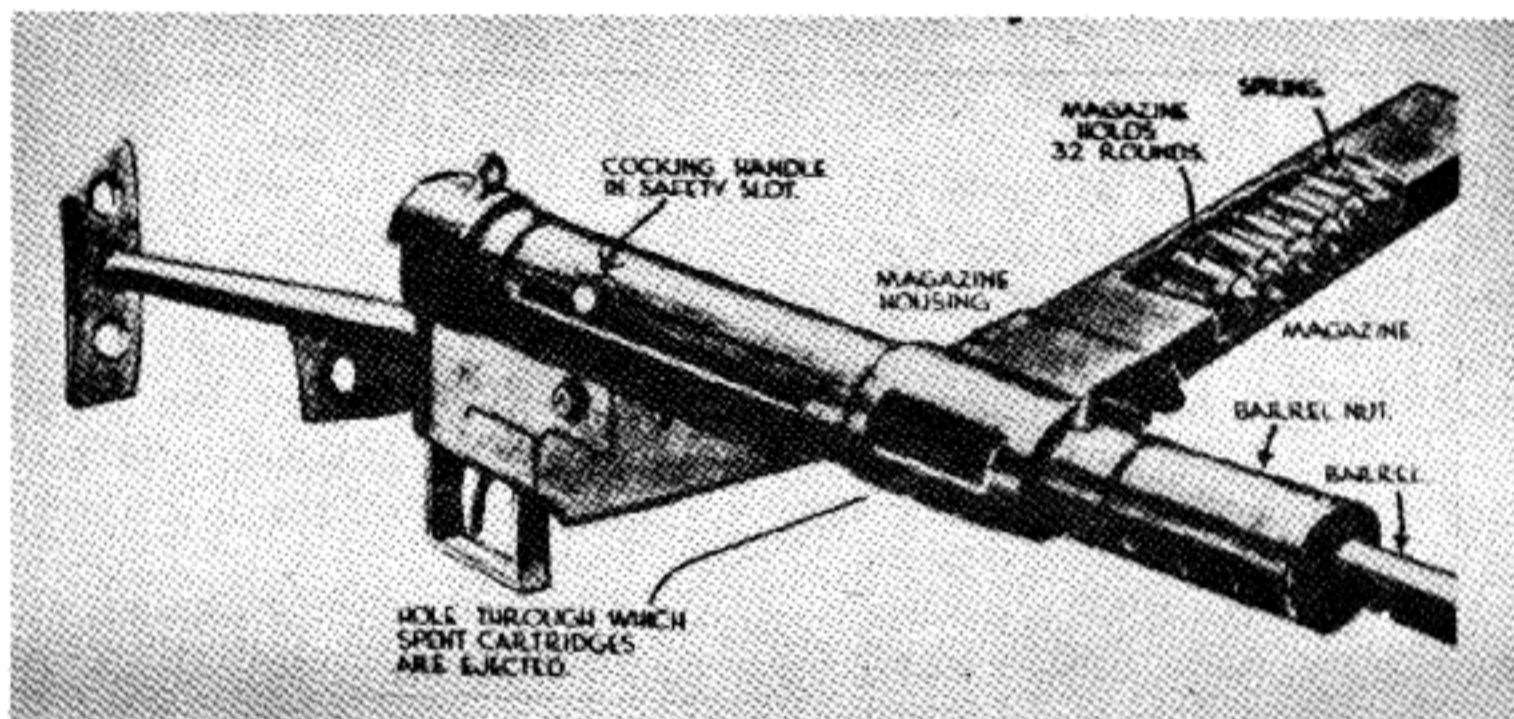

Details of the Sten Submachine Carbine, with Magazine cut away to show position of Cartridges.

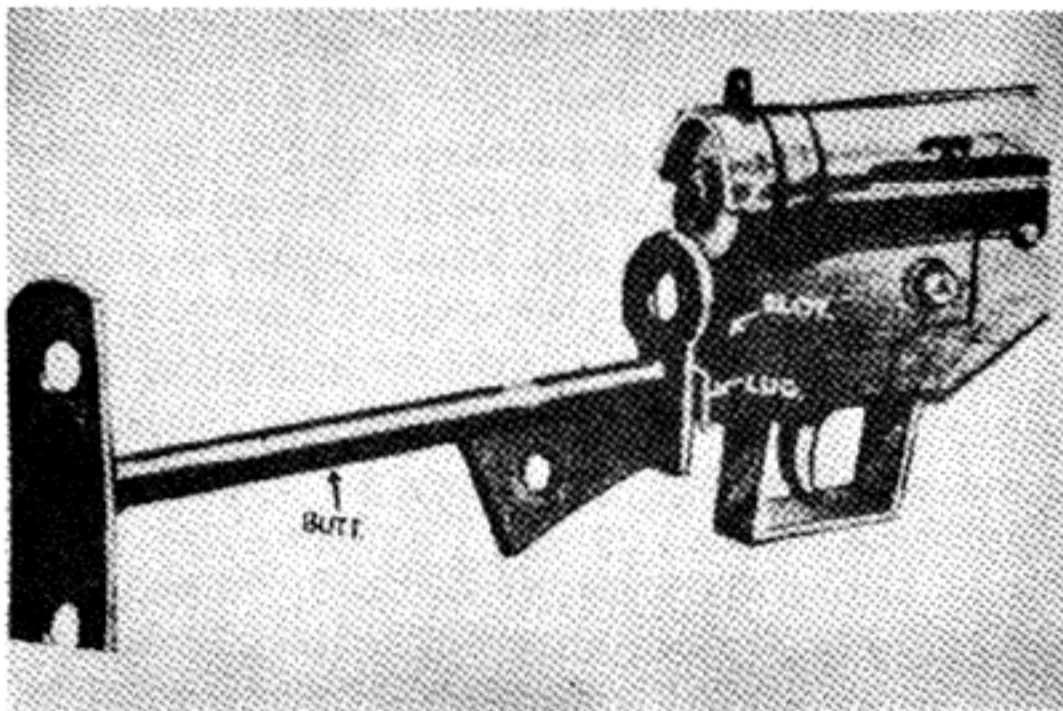

Press in the Stud on Return Spring Housing to clear hole and slide Butt down out of its Slots.

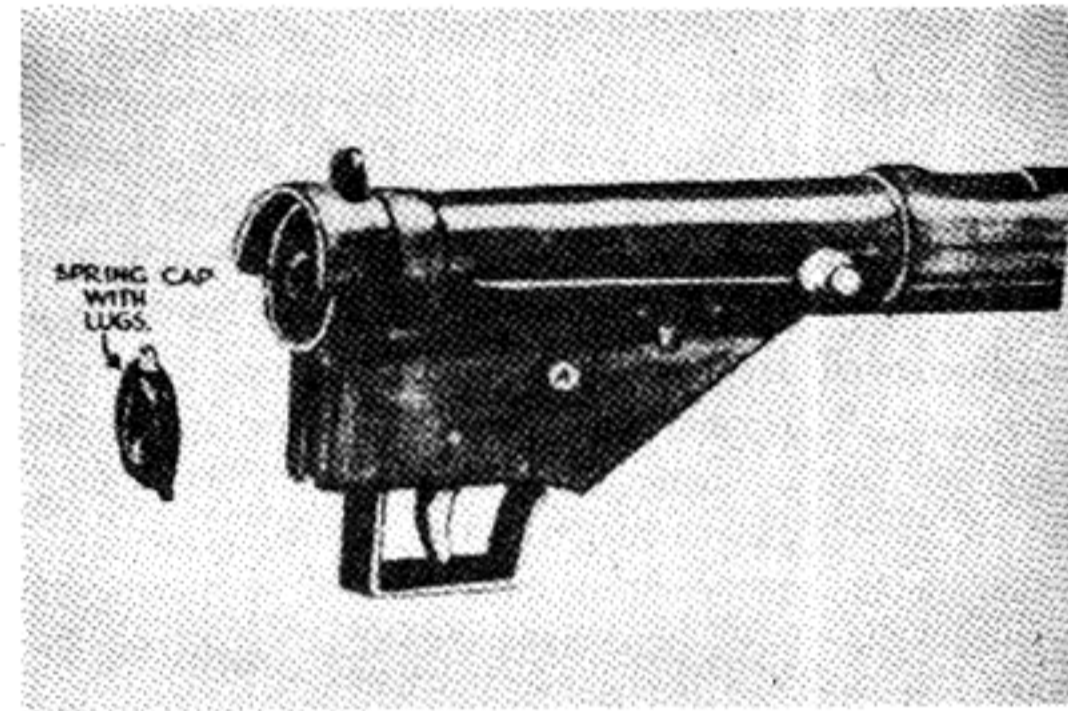

Press in on Stud and Spring Cap and twist to the left to unlock Lugs.

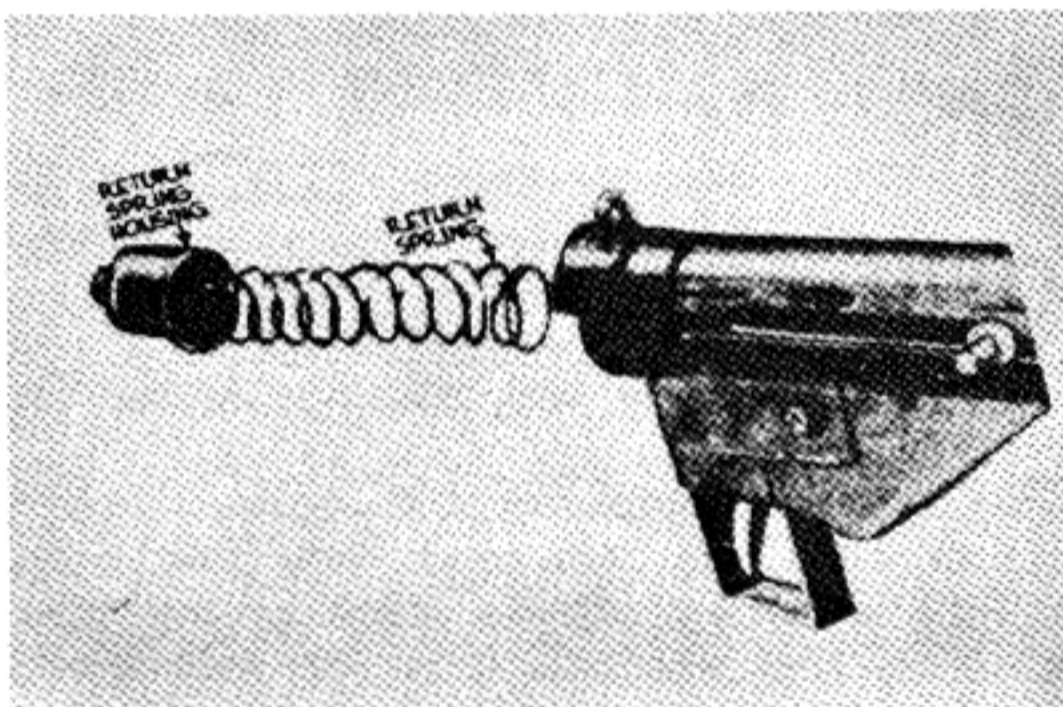

Ease out Spring Cap, Return Spring and Return Spring Housing and remove.

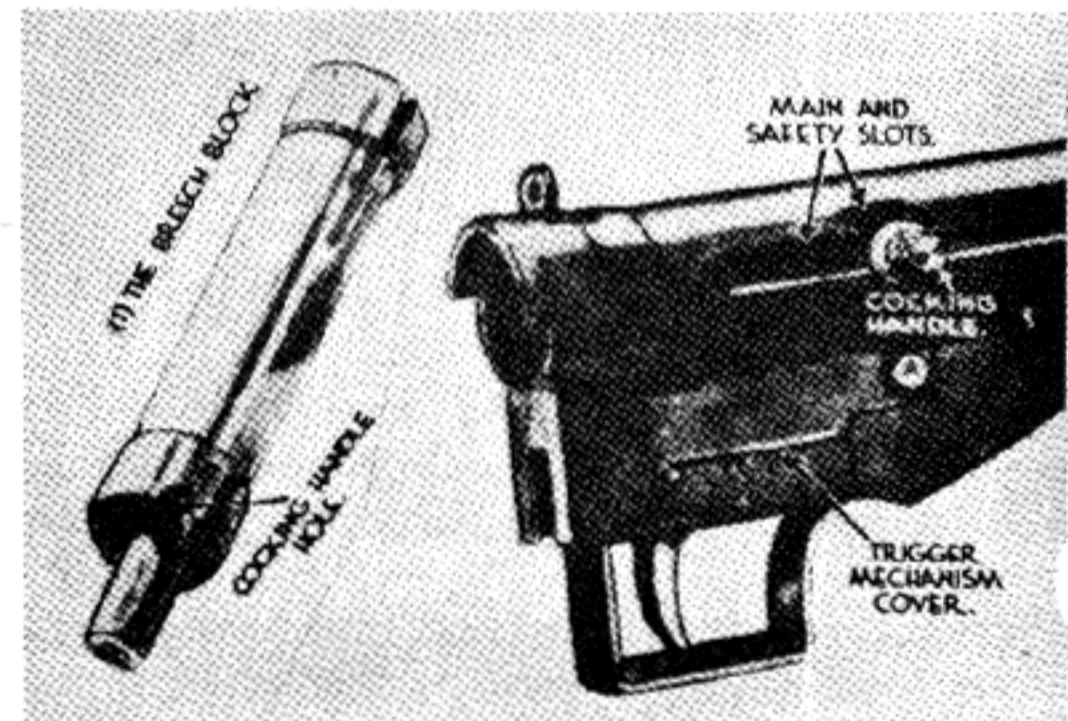

(a) Pull Cocking Handle back to Safety Slot. (b) Rotate until it can be pulled out of Breech Block. (c) Tip up Carbine and slide out Breech Block.

**Barrel Removal:** If necessary, barrel may be removed from Mark I by unscrewing the two screws at the right front end of barrel casing and drawing off the flash hider. In the Mark II, the magazine housing plunger is pulled out, and the magazine housing rotated downwards as far as it will go. This frees the barrel for easy removal.

### REASSEMBLY

Merely reverse the stripping procedure. To prevent damage to breech block, after cocking handle has been inserted pull the trigger and **ease** the breech block forward. In barrel reassembly, look for number or line on barrel. Line this up with the foresight.



# BRITISH COLT .455 AUTOMATIC



This is our own Service Pistol with magazine and barrel modified for use in British and Canadian Armies and adapted to take .455 Webley self-loading pistol cartridge. **All statistical data for the pistol itself is identical with that of the United States Army model.** At first glance the cartridge resembles the .45 Colt Automatic very closely. On examination, however, it will be found that it is of the semi rim-type and not rimless; and its bullet is nearly flat on the point, rather than conical as in our .45.

Although the practice is not to be recommended, the standard United States .45 Caliber Automatic Pistol cartridge may be used in this weapon. Note, however, that the .455 cartridge **will not fit** in the standard U. S. Army pistol of .45 caliber. The reason for this one-way interchangeability of ammunition is to be found in the fact that the actual **bullet diameter** of the United States .45 Automatic Pistol cartridge is .4515"; while that of the .455 Webley S. L. is actually .455". Therefore, the smaller diameter .45 A.C.P. will chamber in the .455, but not the reverse.



# BRITISH (AUSTRALIAN) AUSTEN 9-MM MACHINE CARBINE



**Caliber:** 9mm Parabellum, ball, tracer, or semi-armour piercing ammunition of the Luger type.

**Magazine:** Box type holding 32-cartridges. Positioned in housing on left side of receiver.

**Ballistics:** Standard for cartridges used. (Varies from 915 to 1500 FPS, depending on type and make of ammunition.)

**Barrel Length:** 77/8".

**Overall Length of Gun:** 33 1/4" with stock open. 22" with stock closed.

**Weight, Without Magazine:** 8 3/4 lbs.

**Weight of Magazine:** 1/2 lb, empty.

**Front Sight:** Barleycorn type.

**Rear Sight:** Aperture, set for 100 yards.

**Gun Operated By:** Rearward pressure of gas in firing chamber against the base of the fired cartridge which passes thrust on to the bolt.

**Locked:** Simple blowback. The weight of the recoiling parts and the inertia of the forward motion is sufficient to keep the weapon closed until the bullet is safely out of the barrel and the period of high breech pressure has dropped.

**Cooled:** Air. Bolt stays open between shots permitting circulation of air down barrel; barrel is also fitted with a half-length barrel casing which is ventilated.

**Cyclic Rate of Fire:** 500 to 550 per minute.

**Position of Cocking Handle:** Right side of gun.

**Type of Fire:** Single shot or full automatic. A button

passes through the frame of the gun above and ahead of the front of the trigger guard. If it is pushed from the **right side** where the button is marked, "A" it will fire as long as the trigger is held back and there are any cartridges in the magazine. If the button is pushed through from **the left**, where it is marked "R," it will fire one shot each time the trigger is pressed.



**Safety:** When the gun is cocked, the bolt may be drawn back and turned up so that the bolt handle locks in a slot cut in the top of the receiver. It cannot be fired until the cocking handle is pulled back and turned out of the slot.

## INSTRUCTIONS FOR LOADING AND FIRING

Load magazine exactly as for automatic pistol. Magazine will hold 32-cartridges, but gun will function better if about 28 are used.

Insert magazine in housing on left side of receiver and push forward until it clicks.

Pull the cocking handle back as far as it will go. It will be held back by the sear, and is now ready for firing when the trigger is pressed.

The folding skeleton stock may be opened by pushing down on the release plunger and pulling back the stock.

## HOW THE AUSTEN GUN WORKS

Starting with the gun loaded and cocked the action is as follows:

When the trigger is pressed it moves the sear down out of its contact with the bent of the bolt. The compressed recoil spring in the telescoping tube is now free to drive the bolt forward. The front section of this tube has the firing pin attached to its front end. This first section is seated inside a hole in the bolt, and the firing pin protrudes through its hole in the front face of the bolt; but is blocked by the heavy extractor from striking the cartridge until the weapon is in fully forward position. Feed ribs are cut in the side of the bolt and these strip the top cartridge from between the cutaway lips of the magazine and push it into the firing chamber.

As the cartridge is chambered, the heavy extractor cams up over the base of the cartridge, and its hook snaps, under the tension of the extractor spring, into the cannellure of the cartridge case. At this point the firing pin is free to strike the primer and explode the cartridge.

As the powder explodes, the bullet is driven down the barrel and since the weight and inertia of the moving parts is very much greater than that of the bullet, most of the energy moves forward down the barrel. Thus although the rearward action starts at the same time, opening the breech is delayed long enough to assure that the moment of dangerous breech pressure passes before it opens.



# BRITISH (AUSTRALIAN) AUSTEN 9-MM MACHINE CARBINE

As the bolt starts back, the extractor draws the empty cartridge case with it; this case is struck against the ejector and pivoted out the right side of the gun and then the extractor spring snaps the extractor back into its place. As the bolt in its rearward travel passes the mouth of the magazine, the magazine spring forces the next cartridge into line ready to be picked up on forward motion.

The rear buffer end of the recoil spring tube is firmly supported by the cap and retaining ring through which

it passes. Hence as the bolt goes back, it telescopes the heavy steel sections, one over another compressing the spring inside.

If the selector has been set for single shot fire, the bolt rides over the sear nose which springs up and catches in the bent of the bolt holding it open for the next press of the trigger. If the selector has been set for full automatic fire, it is not retained and the bolt is free to move forward to fire the next cartridge.

## FIELD STRIPPING

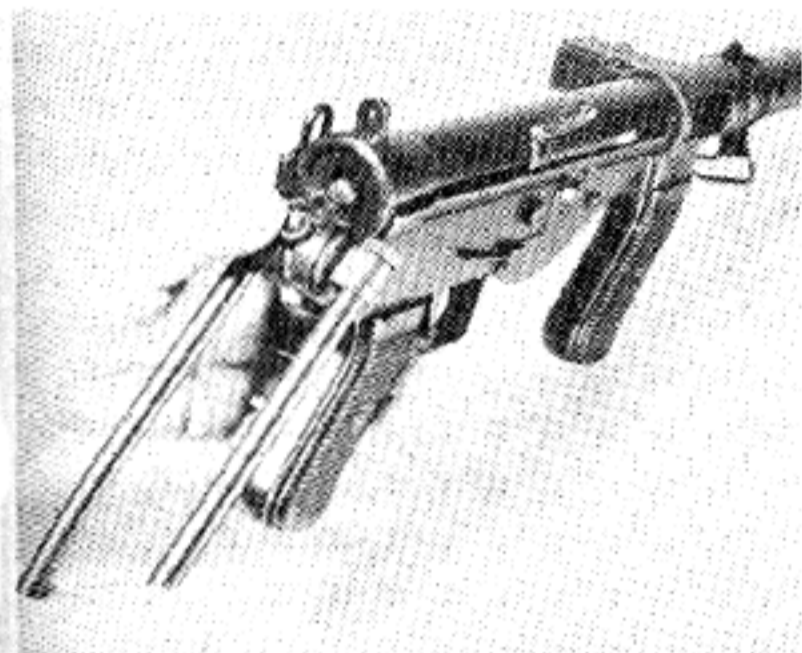

1. Push down on stock locking plunger and bend the stock down out of line with the rear of the gun.

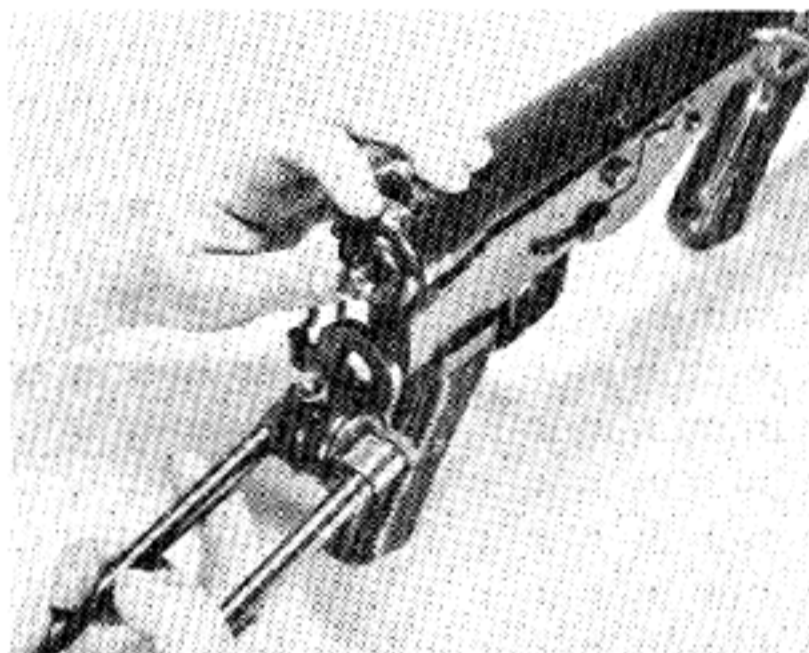

2. With the left thumb press in on the head of the spring tube protruding through the back of the gun. With the right hand

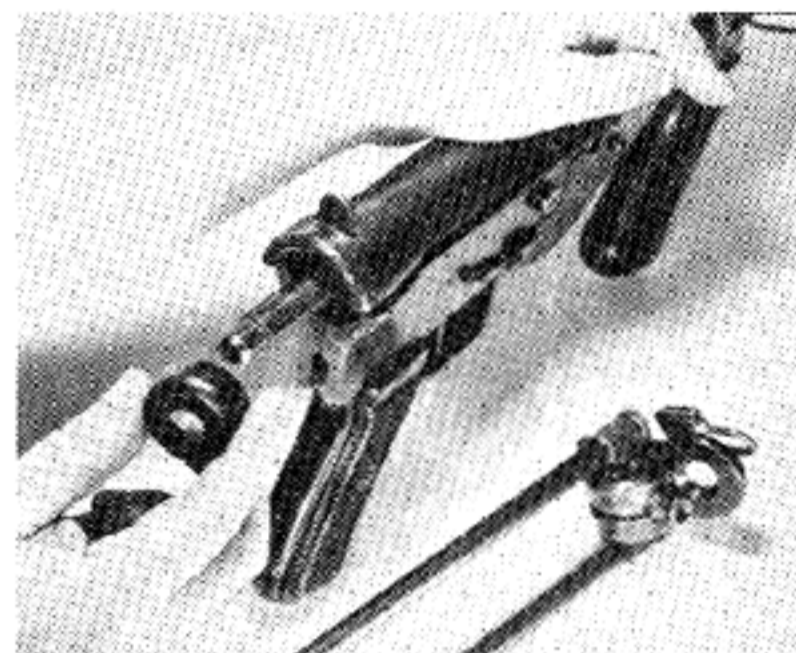

grasp the stock firmly and slide it down out of its locking groove in the rear of the receiver.

3. Lift out the buffer retaining cap.

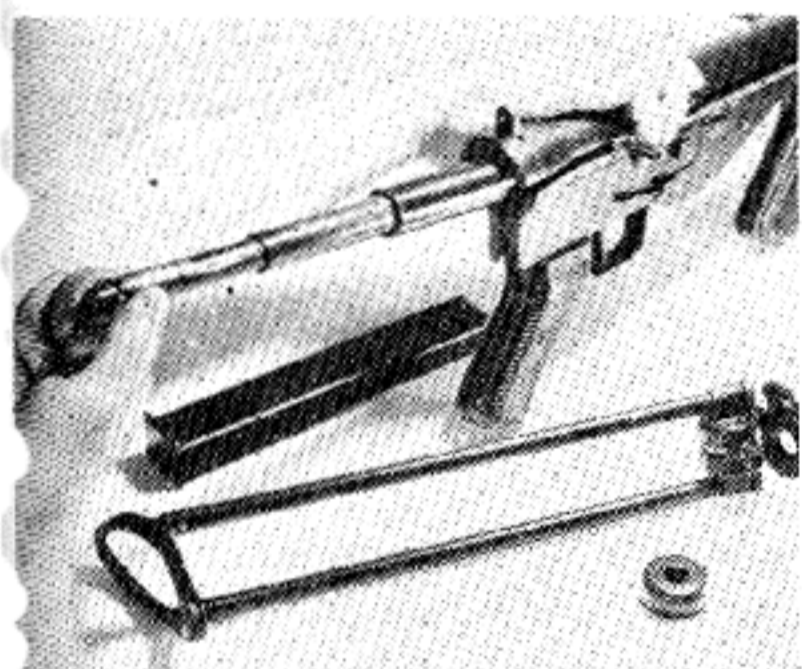

4. Pull back the cocking handle which will bring the recoil and buffer spring tube back and pull the telescoping tube out of the receiver.



5. Now pull the bolt back out of the gun. The extractor may be punched out of the bolt if necessary.

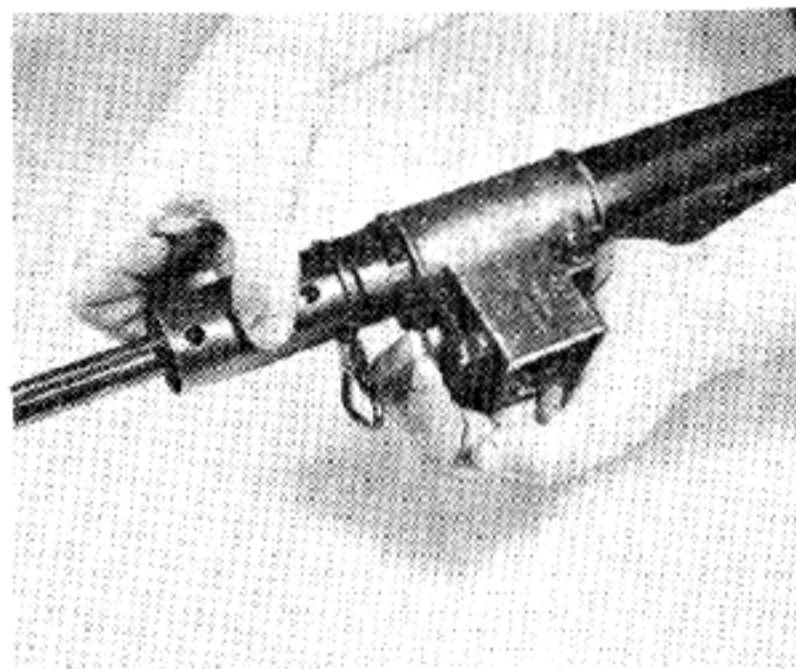

6. With the fingers of the left hand, pull back the barrel nut catch against its spring tension (It is at the front end of the magazine housing on the left side of the gun) and with the right hand unscrew the barrel casing and barrel nut to the right.

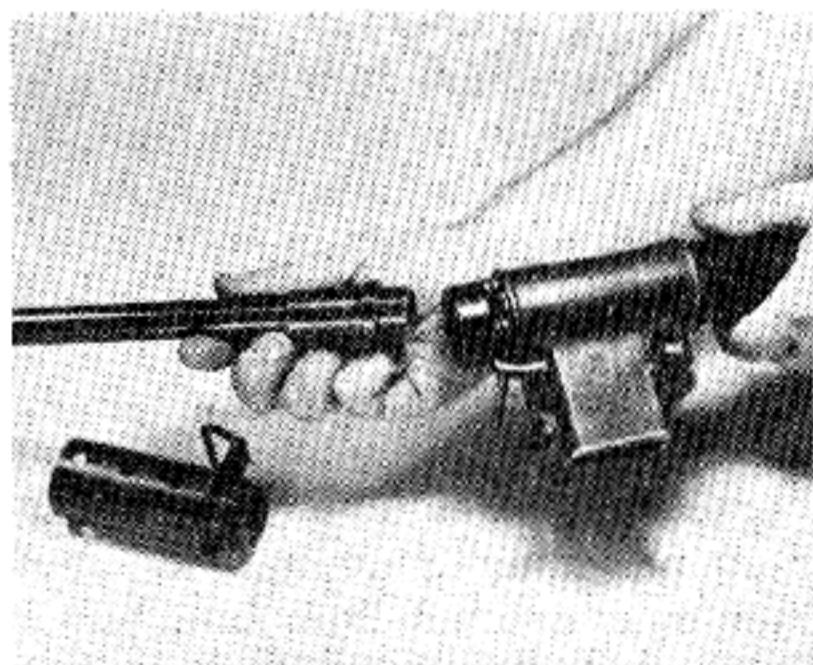

7. Pull the barrel nut and casing forward out of the receiver. Pull barrel straight forward out of the receiver.



This completes field stripping.



# BRITISH (AUSTRALIAN) AUSTEN 9-MM MACHINE CARBINE

## SPECIAL NOTE ON THE AUSTEN GUN

This submachine gun (or machine carbine as the British term it) is one of the most remarkable developments of the present war. It combines all the best features of the famous British Sten and the almost equally famous German Schmeisser submachine guns. The Sten Gun was originally adopted by the British to provide a very cheap submachine weapon which would be absolutely reliable, accurate, and would not be subject to serious jams encountered in the more expensive submachine guns which are very accurately machined, are equipped with alleged locked devices, and require special lubricating systems.

However, the Sten Gun has several faults, among which may be mentioned the fact that the weapon cannot be fired except with the shoulder stock attached; the recoil spring is subject to kinking under some conditions of firing; and a front-end design which makes it possible for the fingers to be injured or burned under some conditions of action while supporting the weapon.

The Australians combined the best features of the Sten with the best features of the Schmeisser and added several entirely unique details to make this remarkably

fine weapon. While the German Schmeisser skeleton stock was adopted, it was fitted with an improved lock which makes it very rigid when used as a shoulder weapon. The Schmeisser type of bolt and telescoping recoil spring tube (probably the simplest of all such systems) was adopted, but was fitted in the Sten-type receiver which permits easier cleaning and dismounting than does the German. The magazine was mounted on the left side as in the case of the Sten Gun, which permits the weapon to be used from a prone position with much more ease than does the bottom positioning of the magazine. A simplified form of barrel removal was developed, which permits the barrel to be speedily changed when it is overheated, or if it is to be replaced or cleaned.

It will further be noted that this weapon is chambered to handle cartridges available in almost every corner of the world. It can use Italian-type ammunition, and all the other forms of 9mm ammunition generally used under the name of Parabellum in Europe.

This cartridge with different powder loads is used by the Germans and the Russians.



# DANISH MADSEN 8-MM LIGHT MACHINE GUN

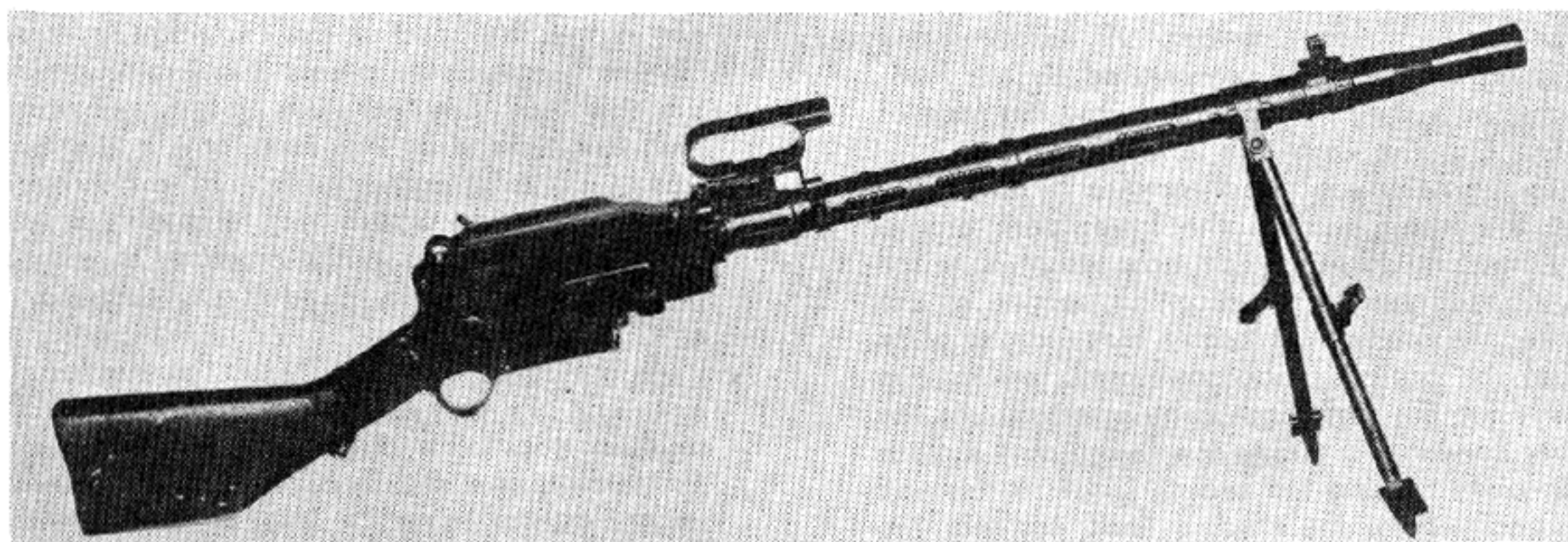

Originally this is a Danish gun of 8mm caliber. However, Madsen guns have been widely used for years in Holland, the Dutch East Indies, England, Germany and Japan, as well as in several South American countries. Moreover Dutch Madsen guns captured by the Japanese have been found in use by our troops in the Solomons. In view of these facts, it would seem that some general understanding of the Madsen gun might be of interest.

**Caliber:** 8mm (.315 inch). Caliber varies in different countries. 6.5mm, 7.7mm and 7.92mm are common.

**Magazine:** Arc shaped. Containing 25 or 40 cartridges. It is mounted on top of the receiver. **Note:** Magazines of 30 capacity are also known. The caliber will to some extent determine the maximum capacity which will usually be 40.

**Barrel Length:** 18 $\frac{3}{4}$ " and 23 $\frac{1}{8}$ ". These lengths are of the Danish gun. Shorter and longer models are in use in other nations.

**Overall Length:** Usually 40" to 45" depending on barrel length.

**Mounting:** In the infantry type these weapons are usually provided with a stock rest at the rear and the bipod mount in front. Weight is about 2 lbs. Special cav-

alry types of mounts are also issued weighing about 1 $\frac{1}{2}$  lbs. Tripod and A.A. mounts also used.

**Sights:** Barleycorn front and open V rear sighted to 1000 meters.

**Gun Operated by:** Recoil.

**Locked:** By hinged block. Breech block and barrel are firmly locked during the moment of high pressure, but as pressure drops and parts recoil, a stud working in a groove pulls the breech block down out of its locking arrangement with the barrel.

**Cooled:** Air cooled. The weapon stays open between shots permitting circulation of the air through breech and down barrel. Barrel is also surrounded by ventilated casing.

**Cyclic Rate of Fire:** About 450 a minute.

**Position of Cocking Handle:** Right rear of receiver.

**Type of Fire:** Single shot or full automatic. On the left side of the receiver is a selector device. One of the stops on this device is a safety. This device can only be set when the gun is cocked. This gun ejects through the bottom. A cover over the opening springs open when the weapon is cocked. It should be closed after firing.

## LOADING AND FIRING

Like the Chatellerault and the Bren guns, the Madsen uses a top loading magazine. This requires the sights to be set off to the side of the gun. The magazine is arc-shaped, as necessitated by the use of rim-type cartridges which cannot lie flat on top of each other.

1. Pull the cocking handle back as far as it will go and release it.

2. Put the forward end of the magazine into the for-

ward end of the magazine opening and lower the rear end down into place, snapping it down until it locks. Now set the selector on the left side of the receiver above the trigger in the fire position. **Note:** Remember that this weapon fires as the bolt goes forward and no attempt should ever be made to let the action go forward while there is a magazine mounted on top of the gun.

## HOW THE MADSEN GUN WORKS

This gun fits into a subdivision of functioning principles, known as the "long barrel recoil type." In the short recoil types, the barrel moves backward only a fraction of an inch, which means that extraction and ejection of empty cartridge cases and feeding loaded cartridges requires special attention. This design is necessarily more complicated than the long recoil type.

In the long recoil type the breech has to move back far enough to permit feeding up the entire cartridge in one operation. This is done by the barrel going forward while the lock is held back until the cartridge has partly entered the chamber. In this type of action, the rate of fire is much lower than in the short recoil.

**Starting with the gun cocked and in firing position the**

**action is as follows:** As the trigger is pressed, the spring below it is compressed while the trigger nose is pulled down out of the bent of the recoil lever. This permits the recoil spring in the butt to force the lever downward, and as it is engaged in the rear of the breech mechanism, it thrusts the recoiling parts forward. As the recoiling mechanism nears forward position, the recoil arm is still up somewhat. The hump on the recoil lever now bears on the side of the sear and forces the sear downward. The nose of the sear is thus relieved from the bent of the firing lever, and compresses the sear spring. The firing lever is now forced downward by its spring and strikes the tail of the hammer. The front of the hammer drives the firing pin forward to explode



# DANISH MADSEN 8-MM LIGHT MACHINE GUN

the cartridge in the firing chamber. A coiled spring around the firing pin, which is compressed by the hammer movement, pulls the firing pin back into the face of the breech block as the cartridge is fired.

As the recoiling parts are thrust forward by the recoil lever spring, a circular stud in the lower part of the breech block, working in the guide grooves of a switch plate which is fitted to the non-recoiling portion of the receiver, strikes the rear of the center block in the plate and so guides the breech block downward, leaving the chamber ready for the cartridge to be inserted. As the stud continues forward, it strikes the lower cam surface of the switch plate causing the breech block to rise and close the breech. Now the stud is lined up with the horizontal slot in the switch plate down which it travels during the final half inch forward motion, securely locking the breech.

Also during the forward thrust of the recoiling parts, an arm is forced up by a cam on the left side of the receiver, forcing outwards the distributor against the tension of its spring, and permitting the first cartridge from the magazine **which was resting on the distributor** to drop into the magazine opening.

Meanwhile the front surface of the rear claw of the feed arm engages with the rear surface of the feed arm actuating block, thus rotating the feed arm forward. The

arm strikes the head of the cartridge in its seat against the left flange of the breech block, pushing it ahead into the chamber. The rear claw of the feed arm rises up to the rear surface of the feed arm actuating block and travels along its upper surface. The bottom of the rear claw, now being above the feed arm actuating block, moves the cartridge in the chamber to allow the breech block to rise. It also prevents any rebound of the feed arm.

As the forward action starts, the ejector is positioned alongside the rear of the ejector block. As the recoiling parts go forward a stud on the ejector lever rides down the sloping cam and forces the ejector downward on its spring, thus bringing the lever in contact with the tail of the ejector. As soon as the breech block starts to rise, the tail of the ejector is clear of the ejector block and it is raised in position by its lever. As the breech closes, the ejector is able to rise to the vertical under the influence of the ejector lever spring and falls in place just below the chamber with its hook below the rim of the cartridge.

Note that in this type of gun, the cartridge is not set into the chamber by the breech block; and until the front of the breech block rises to a complete locking position, the hammer, firing pin and cartridge **are not in alignment** and so there can be no accidental discharge.

## RETURN MOVEMENT OF THE ACTION

At the breech, the barrel is joined to the breech block casing in which are the hinged breech blocks. These three units recoil together, with the breech remaining closed and locked for about  $\frac{1}{2}$ ". This sudden rearward thrust forces the firing lever up as it is struck by the rear of the breech mechanism, and frees it from the hammer, which permits the hammer to pivot back and the firing pin to be withdrawn by the firing pin spring. The guide stud is now passed out of the horizontal groove and travels up the upper cam of the switch plate which pivots the breech block upwards at its nose to permit ejection. The extra stud travels along the top of the cam and the cover spring then forces the front of the breech block downward, compelling the stud to drop out of the rear stud of the switch plate.

**Note:** This gun has **no individual extractor**. The ejector pulls the empty cartridge out of the chamber and hurls it from the gun.

With the first movement to the rear, the inclined slope in the front of the ejector block raises the ejector which is held in vertical position by its lever which is engaged in a recess in the bottom of the ejector. From the influence of this separate movement a hook on the ejector catches the rim of the empty cartridge case and the bottom of the ejector lies on top of the front flats of the ejector block.

Now the stud on the ejector lever runs up the sloping cam on the left of the ejector block to compress the ejector lever spring. This also disengages the ejector lever from the ejector, allowing the ejector tail to be

tripped forward by the step on the ejector block, and as the ejector is pivoted about its center, the tripping motion of the tail forces the hook to the rear, pulling the empty cartridge case out and hurling it from the bottom of the gun.

An ejection guide on the breech block guides the empty cartridge case as it is hurled out. The ejector lever stud now rests above the sloping cam holding the ejector lever upwards and free of the ejector, which lies on top of the rear flap of the ejector block beneath the breech block. During the recoil movement, the distributor arm rides down its cam and rotates the distributor inwards and downwards under the influence of the spring. This places the cartridge in the feedway against the left flange of the breech block. Meanwhile, the rear surface of the front feed arm claw engages with the front face of the feed arm actuating block, and rotates the feed arm backwards. The bottom of the front claw now rides along the top of the feed arm block preventing rebound of the feed arm.

**Further Note on Recoil System:** Some Madsens are fitted with a so-called "recoil increaser" which forms a choke at the muzzle. By reversing the two parts of the increaser, the rear portion forms a collar which forces the gases escaping at the muzzle to rebound onto the barrel and give an additional thrust to the rearward action. This speeds the gun up greatly.

When the gun is cocked, the claws of the feed arm automatically open the ejector cover. It must be closed by hand on cease fire.



# DANISH MADSEN 8-MM LIGHT MACHINE GUN

## FIELD STRIPPING

1. Remove magazine from gun and ease recoiling parts forward.
2. Lift the locking bolt lever into vertical position and withdraw it to the left.
3. Push the butt to the right front meanwhile gripping the receiver with the left hand; and then remove the butt.
4. Holding forefinger of right hand ahead of feed arm axis bar, with the hand draw back the barrel and breech mechanism.

5. Now pull out the barrel. Remove barrel very carefully as it is easy to damage the front end ring. This barrel ring is one of the weak points in the weapon. Handle it carefully.

6. Now remove the breech block bolt.

7. Pull feed arm to the rear. **Lift** the front and **lower** the end of the breech block, and then pivot the front up back to vertical position, when the feed arm may be eased forward and lifted out of the block.

Further dismounting need not be attempted.

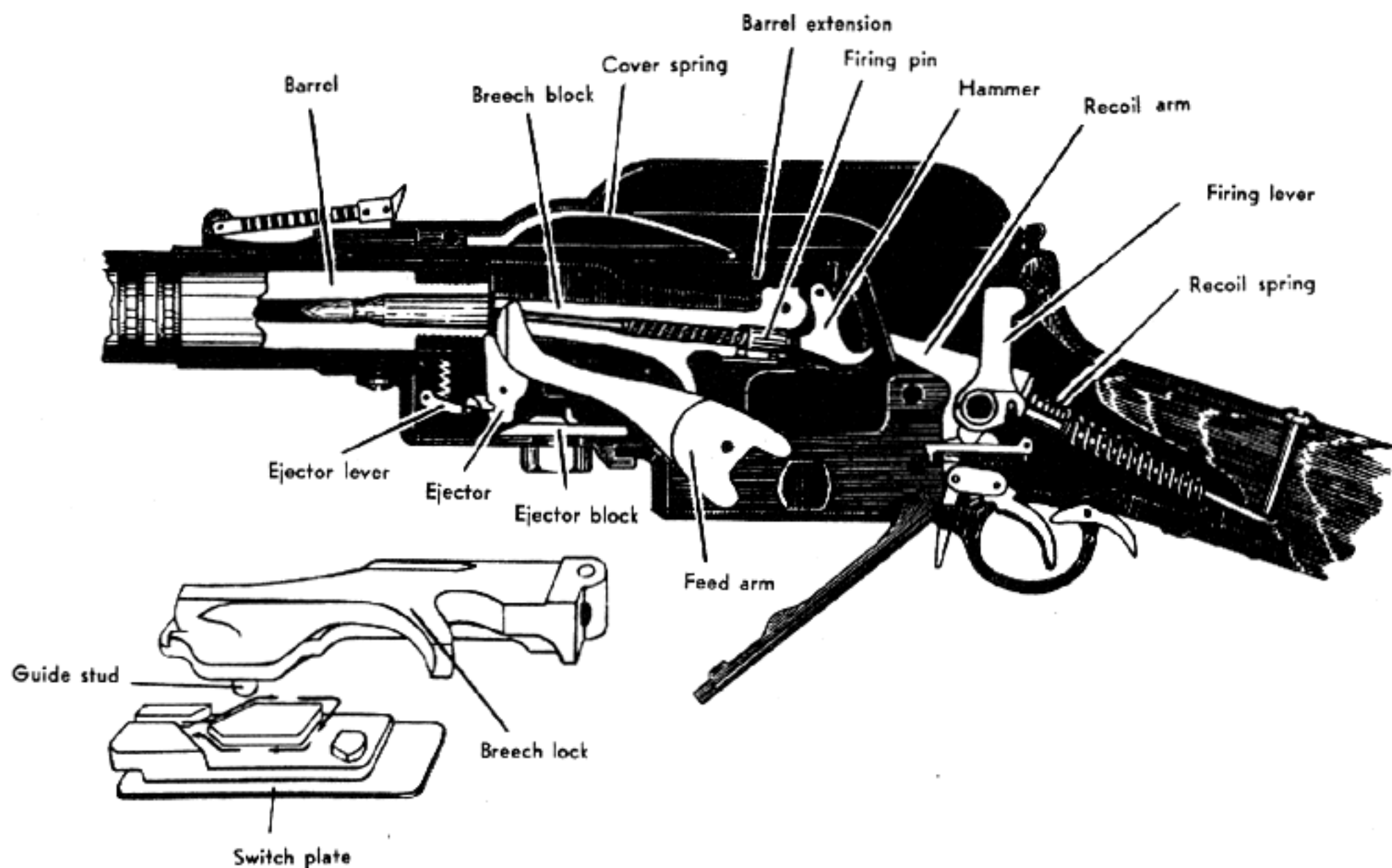



# FINNISH SUOMI 9-MM SUBMACHINE GUN

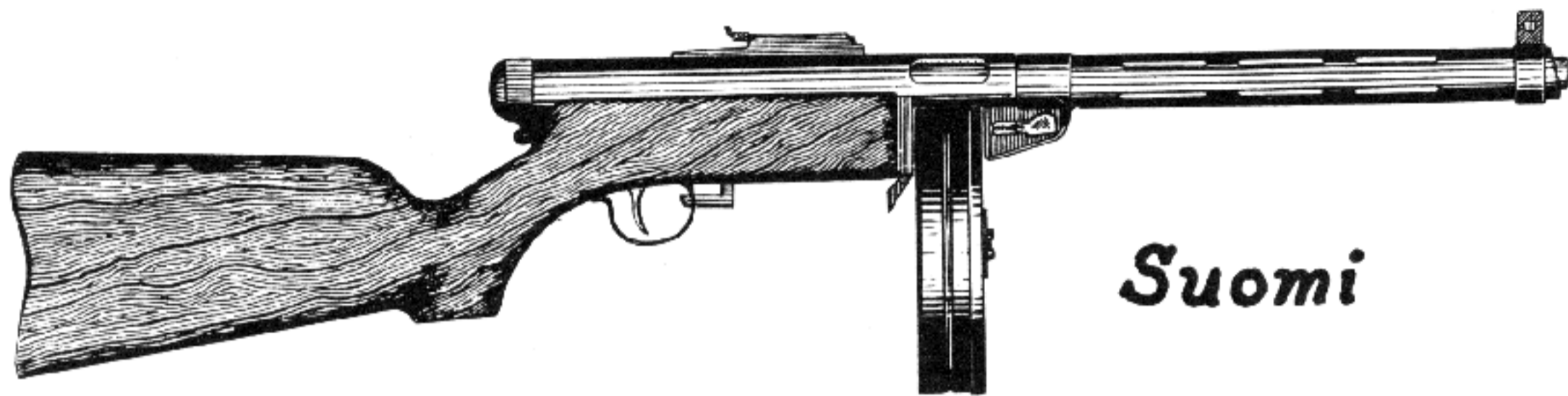

**Note:** This weapon is one of the most remarkable developments of the present world war. Its simplicity, ruggedness, reliability, ease of operation, are all outstanding in machine pistol construction. Added to these qualities, it costs less than a good pistol and is easy to manufacture. The Russians are making wide use of a modification of this weapon.

**Caliber:** 9mm Parabellum. (This is also the pistol cartridge of the Finns.)

**Magazine:** (a) Box type usually holding 20 or 30 cartridges. (b) Drum type containing 59 cartridges.

**Position of Magazine:** Directly under receiver, positioned from below.

**Magazine Catch:** Behind magazine, released by pushing forward.

**Sights:** Open, adjustable to 300 meters.

**Cocking Handle:** Positioned at end of receiver, directly under milled recoil spring cap. Drawn back with thumb and forefinger of right hand, it cocks the bolt. Its spring automatically returns it to its seat.

**Cyclic Rate of Fire:** 400 rounds per minute.

**Type of Fire:** Full automatic only. With experience, trigger may be tapped to fire in bursts of 2 or 3 shots.

**Safety:** A lever bar directly in front of trigger guard.

**Operated:** By recoil.

**Locked:** Blowback type.

**Unlocked:** Bolt held closed during moment of firing by inertia of moving parts and heavy recoil spring.

**Firing Pin:** Machined into bolt.

**Cooling:** Slotted barrel-casing surrounding barrel serves as ventilator.

## LOADING AND FIRING

A loaded magazine is inserted below into the magazine housing and pressed up until it locks. The cocking handle protrudes from the rear of the weapon under the milled recoil spring cap. Grip it firmly, pull back to the rear to compress the bolt spring and cock the bolt, and allow to run forward under the influence of its own spring. Pressure on the trigger will now fire the weapon. The bolt will stay back between shots. When a continuous burst of fire is required, maintain a firm stiff pressure. **Remember that this is a full automatic weapon,** and that the trigger is the **only** fire control. Releasing it will stop the working of the action.

## STRIPPING

At the rear of the receiver is a heavy milled cap. Unscrew this cap and ease out the housing recoil spring guide, and recoil spring. Drawing back on the cocking handle will now pull the bolt back for removal from the weapon.

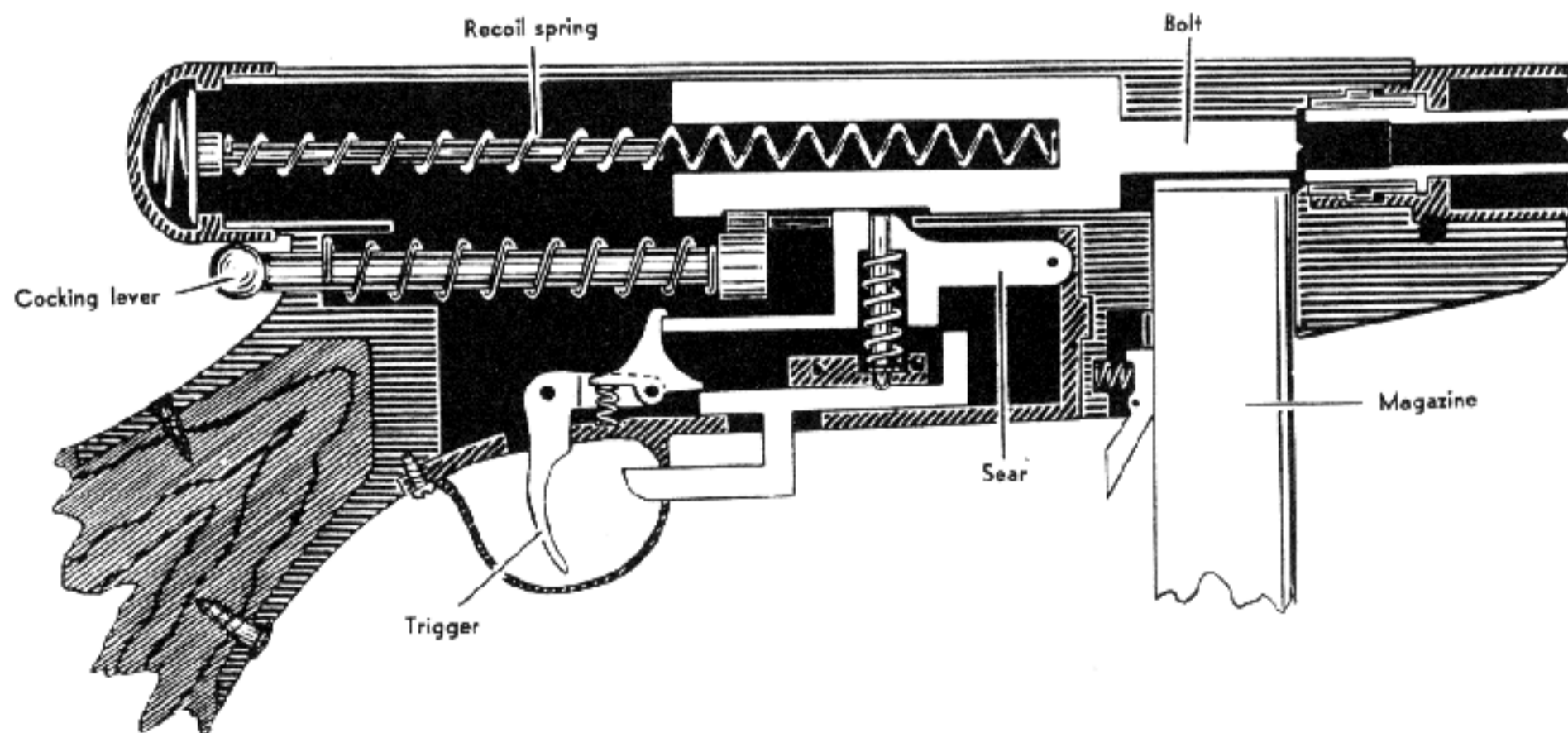



# FRENCH MODELE D'ORDONNANCE 1892 REVOLVER

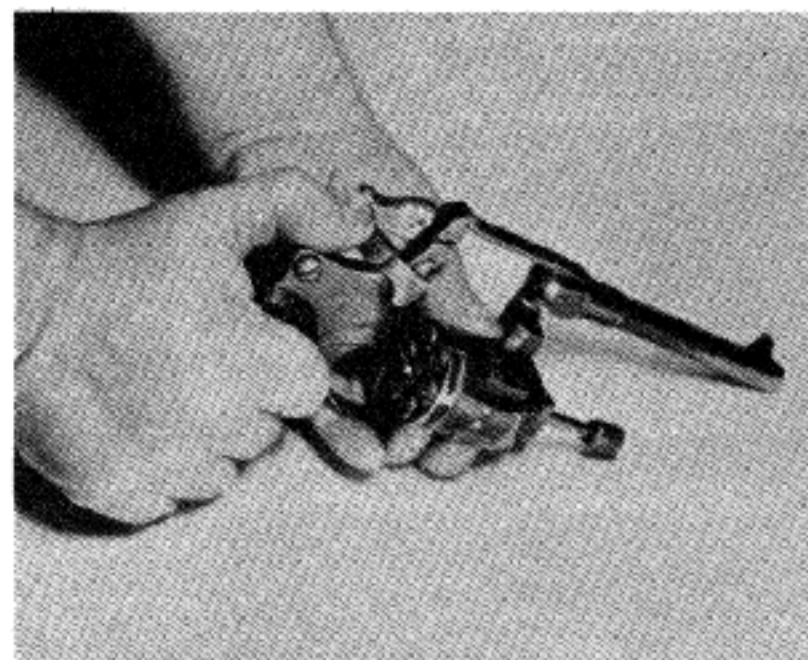

**Caliber:** 8mm, .315 inches.

**Cylinder:** 6 shots.

**Muzzle Velocity:** 625 feet per second.

**Weight of Bullet:** 102 grains lead.

**Muzzle Striking Energy:** 104 foot pounds.

**Barrel Length:** 4".

**Type of Action:** Double action. Hammer may be cocked by the thumb or the entire firing action may be produced by pulling straight back on the trigger.

**Cylinder Release Catch:** This is a thumb piece on the right side of the revolver. It is swung directly back and down on its pivot. The cylinder then may be swung out to the right.

**Extraction:** Pushing up on extractor rod, unloads revolver in exactly the same manner as the Colt revolver. All chambers are ejected simultaneously.

**Note on Ammunition:** This is a freak cartridge somewhat resembling our .32-20. Bullet is copper jacketed and cartridge loaded with black powder. This cartridge is popularly called the 8mm Lebel.

## STRIPPING

1. With a screw driver, turn the large dismounting screw on the right side plate above the grip. This will force out the hinged plate on the left side of the revolver extending from the grip forward to the under side of the frame.

2. With cylinder swung out to the right, the entire working mechanism of the pistol is now available for cleaning or repair.

**Note:** This is the official French Service Revolver and is commonly referred to as the Lebel. However, French weapons are very often named after the arsenal of manufacture, without regard to the original name or designer. This accounts for the fact that some models of this revolver in use in the French Foreign Legion are often called Ruby Revolvers.

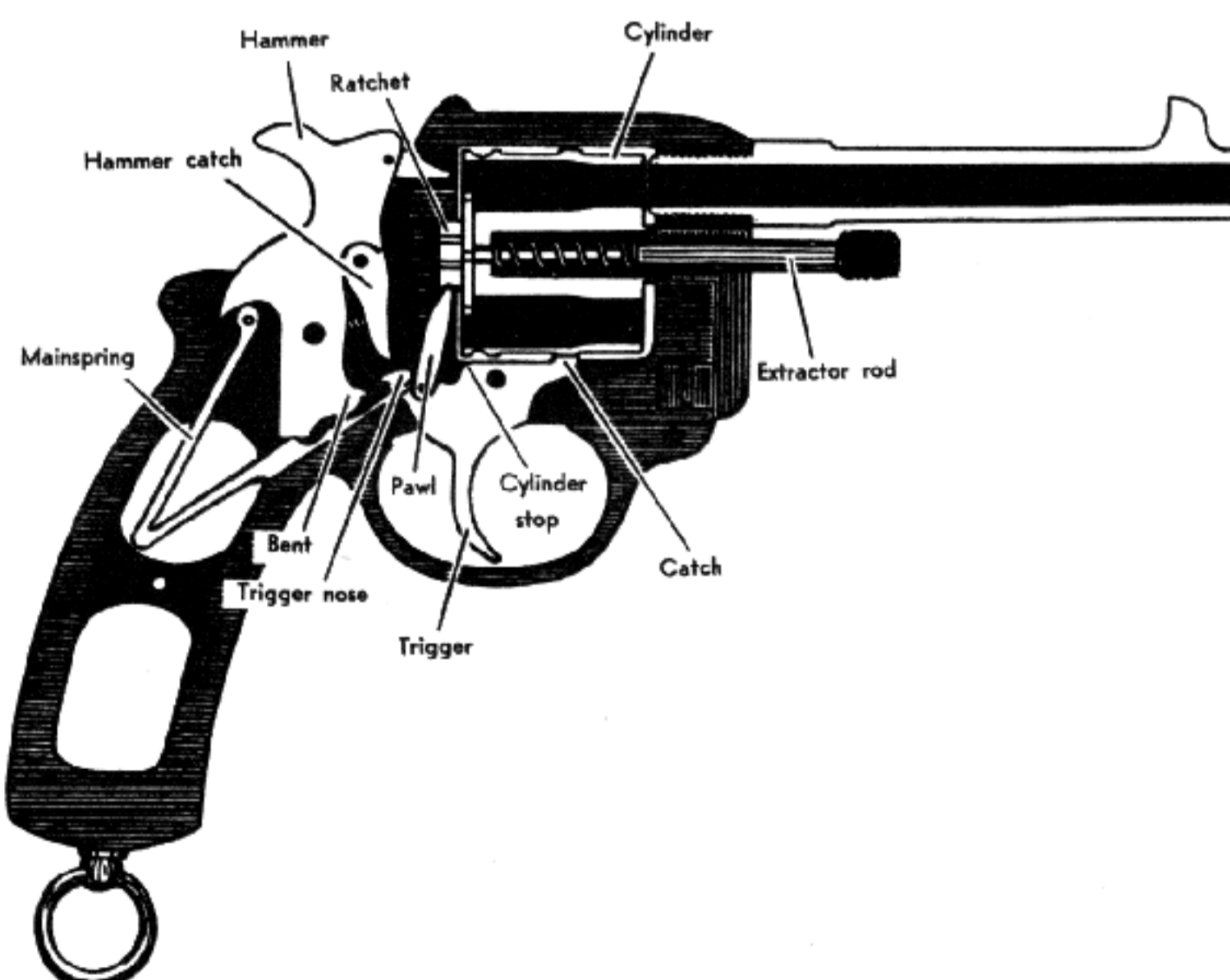

Working Drawing Showing Parts and Functioning French Service Revolver



# FRENCH RUBY 7.65-MM AUTOMATIC



This is a poor imitation of the standard Colt Pocket Automatic pistol. Magazine catch is in bottom of handle. Pistol weighs 34 oz., is 6" overall. The barrel length is 3 1/2". Magazine capacity is 9-cartridges. This pistol uses the standard 7.65mm Browning Automatic Pistol Cartridge. This is in common use in Europe. In the United States this cartridge is known as the .32 Colt Automatic Pistol cartridge. The bullet weighs 72 grains and is full metal-jacketed. Cartridges of European manufacture usually give a velocity of 900 feet per second, with a striking energy of about 129 foot pound. Ammunition manufactured in the United States usually develops 980 feet per second muzzle velocity with a striking energy of about 152 pounds.

Insert a loaded magazine in the butt and push up until it locks. Draw the slide back as far as it will go and permit it to run forward. This completes loading and leaves the pistol cocked and ready to be fired. A thumb safety is provided on the left side of the pistol. This is strictly an unlocked, blowback action. The weapon is kept closed during the moment of firing entirely by the pressure of the heavy recoil spring and the weight of the sliding members. This is **not** an effective military weapon.

# FRENCH STAR 7.65-MM AUTOMATIC

**(This is of Spanish manufacture, but widely used in France)**



This is also a straight blowback automatic pistol using the pocket type 7.65mm (or .32 Colt Automatic Pistol) cartridge. However, it differs radically from the other French automatic pistols in that it is loaded with a clip, the cartridges being stripped down from the top when the action is open, exactly as in the case of the Mauser pistol and the Steyr pistol. A thumb safety is provided on the left hand side of the pistol just ahead of the hammer. Action stays open when pistol is empty. When 7 cartridges have been stripped down from the top into the magazine space in the handle, pressing the release stud just above the trigger on the left hand side of the pistol sends the action forward and leaves the weapon ready for firing.

**Note:** This pistol was originally of Spanish design and is widely manufactured in Spain and used throughout South America. It is made by the firm of Echeverria of Eibar, a very important Spanish arms manufacturer.



# FRENCH 1935-A 7.65 LONG AUTOMATIC



This weapon is modeled after our own .45 Colt Automatic Pistol. Magazine release catch is same as for Colt Automatic .45. Trigger mechanism and shape of hammer differs from Colt. There is no grip safety. This pistol is 7 $\frac{1}{2}$ " over all and shoots a specially designed cartridge of 7.65mm caliber. This is a freak cartridge not in ordinary production. It is metal jacketed. It must not be confused with either the Luger, Browning or Colt cartridge of 7.65mm caliber. In general the rules for loading Colt and Browning pistols will cover all essentials necessary to proper handling of this one.



# FRENCH ARMY RIFLES

Numerous rifles were in use by the French. None of them warrant extensive description.

## THE LEBEL, 1907-15 MODIFIED 1916

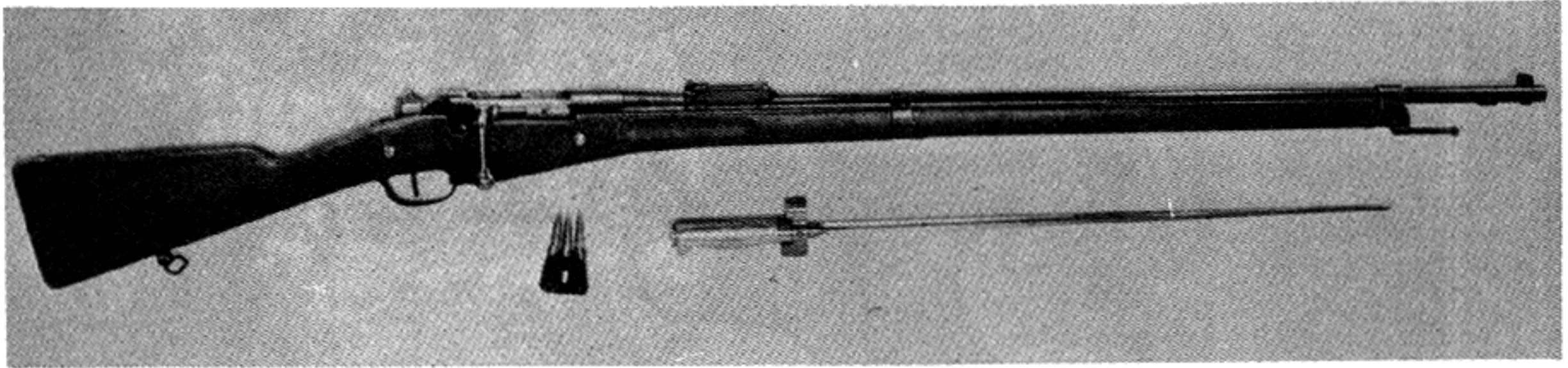

This has a turning bolt action which is clumsy and complicated. The vertical box magazine holds three or five cartridges and is loaded with a clip. Neither cut-off nor safety is provided on this rifle. The rifle weighs

9 lbs. 3 ounces. Barrel is 31½" long in the rifle, and weapon overall measures about 4' 3½" (about 17½" longer with the bayonet attached). Sights are adjustable from 400 to 2400 meters.

## LEBEL CARBINE

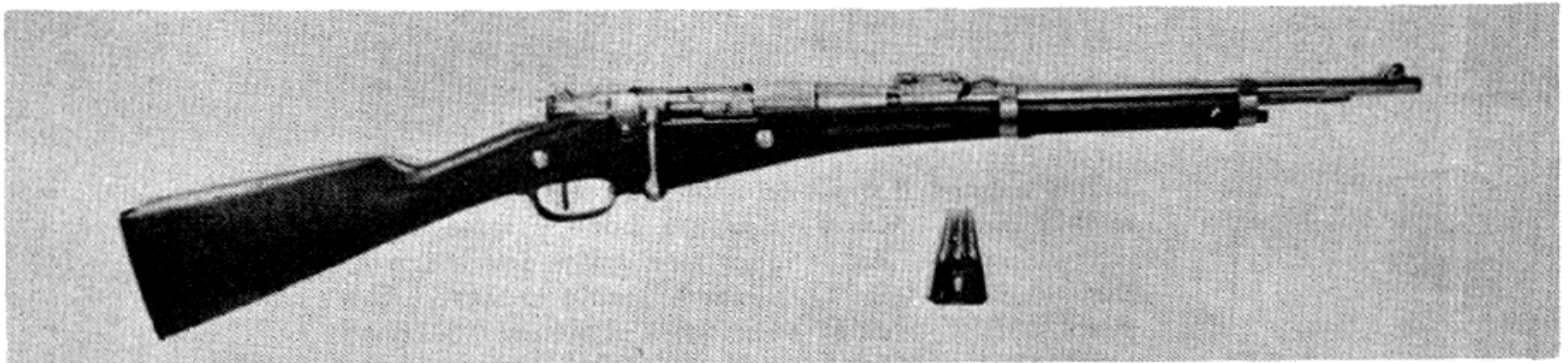

Except for length and weight, this weapon is the same as Lebel rifle. Caliber is 8mm. The bolt is particularly complicated.

## FRENCH RIFLE MAS, 1926

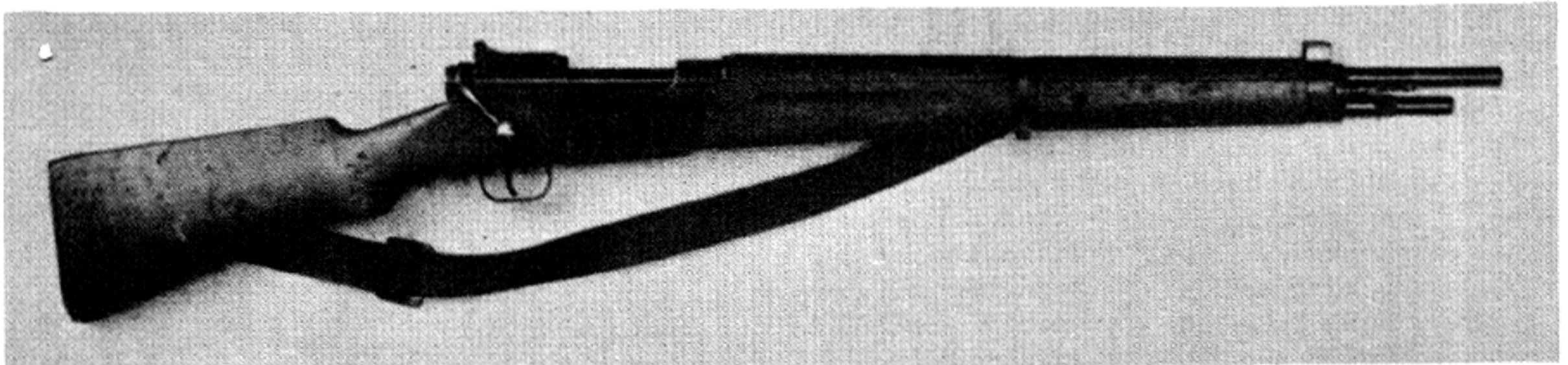

This was one of the last rifles developed by the French before their collapse. By comparison with other French rifles, it is a masterpiece of design; though not to be classed with the United States, British, or German types. It uses a special 7.35mm cartridge.

This weapon is loaded with a Springfield-type clip through the top with five cartridges. The design of the bolt handle is poor for rapid firing. Rifle has an aperture rear sight. It is fitted with a sling for carrying; the sling is not used for supporting the rifle

as in United States practice. On the lower side of the receiver at the front, is a spring button catch which when pushed in, releases a magazine bottom, magazine spring, and follower permitting them to be removed through the bottom of the rifle for cleaning. A skewer-type bayonet is screwed into a tube underneath the barrel. Pressing a spring plunger releases this and permits it to be withdrawn. Then the end protruding below the barrel is reversed and locked into the seat in the head of the bayonet tube.



# FRENCH CHAUCHAT 8-MM MACHINE RIFLE



## (Called Fusil Mitrailleur Chauchat-Sutterre-Ribeyrolle-Gladiator)

This weapon, although obsolescent, was in wide use by the French and the Belgians when this war started. In Europe it is called the Chauchat.

**Caliber:** French 8mm. Belgian Caliber .301. Also manufactured in U. S. during last war for Standard United States Service cartridge.

**Ballistics:** Average for cartridges employed.

**Weight of Gun:** 18 pounds. Fitted with a tripod mount.

**Sights:** Graduated to 1200 meters. This is an inaccurate weapon at best.

**Gun Operated By:** Long recoil. Gas expands in space between front sight cone and barrel and is thrown back against barrel nut thus helping recoil drive the barrel to the rear.

**Locked:** Barrel and bolt securely locked by locking lugs.

**Cooled:** Air. Barrel is heavy and has radial flanges, is also enclosed in a barrel jacket.

**Cyclic Rate of Fire:** About 400 per minute.

**Type of Fire:** Single shot or full automatic. A lever is provided on left side of receiver which may be set for single shot or full automatic or for safe. ("C" is single shot. "S" is safe. "M" is automatic.)

**Flash Hider:** Extension on muzzle to hide the flash of powder burning as it leaves the muzzle of the rifle.

**Position of Bolt Between Shots:** Open. Bolt mechanism travels forward when trigger is pressed to fire cartridge.

**Note on This Weapon:** This is one of the most poorly constructed weapons ever developed. It is included here merely because large quantities are still in general use in Europe. The French types use a crescent shaped magazine because the cartridges have rims. Magazine is loaded with 20 cartridges and inserted in gun from below. Exposed cartridge side of magazine faces to the right. Pulling back the bolt handle prepares the weapon for firing. The recoil in this gun is excessive and the accuracy very poor. This weapon is poor both in workmanship and design.



## NOTE ON STRIPPING

Press magazine catch forward and remove magazine. Ease operating handle forward.

Push down spring guide latch and unscrew spring tube plug (At rear of receiver).

Withdraw plug, mainspring and recoil spring. Bushing will fall out.

Pull back operating handle, turn front assembling bolt arm down, and push rear assembling bolt to the left to clear eyelet.

Lift radiator casing and breech housing clear of frame.

Turn radiator casing upside down and draw operating handle to rear. Lift out feed piece assembly.

Grasp bolt stem and draw out bolt assembly.

Withdraw barrel, barrel nut, radiator, breech casing and barrel sleeve out of breech casing.



# FRENCH 1914 HOTCHKISS 8-MM MACHINE GUN

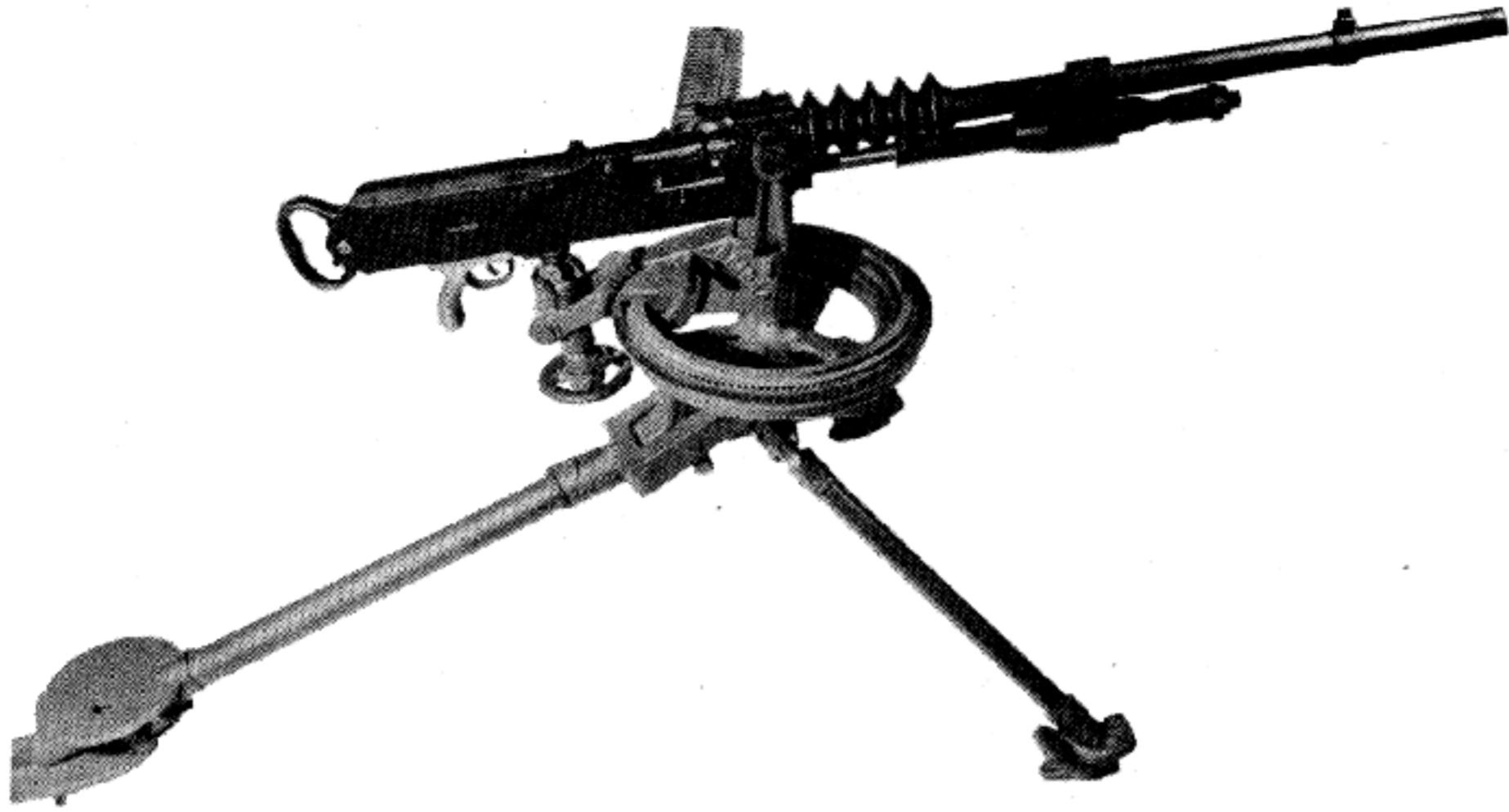

The Hotchkiss is a basic weapon. The French type is heavy and unwieldy. A modification of this model is the basic heavy machine gun of the Japanese. The light improved weapon of this type is widely used in Great Britain. Norway uses a machine gun of this type in Caliber 6.5mm. It is also in use in Spain in Caliber 7mm.

**Caliber:** 8mm French Service Cartridge.

**Type of Feed:** Metal strip, holding 30 cartridges and feeding from the left hand side of the gun.

**Muzzle Velocity of Cartridge:** About 2380 feet per second.

**Weight of Bullet:** About 198 grains.

**Barrel Length:** 30 1/2".

**Weight of Gun:** 52 pounds.

**Mounting:** A 70 lbs. tripod mount is provided for this gun.

**Sights:** Open. Barleycorn front and V rear.

**Gun Operated By:** Gas. As bullet travels down barrel, a small portion of gas escapes through a hole tapped in the under side of the barrel and expands in a cup-shaped piston fitting on a gas nozzle. This imparts a hammerlike blow which drives the action backwards.

**Cooled:** Air; has extremely heavy barrel with five thick radiating rings near the breech.

**Position of Cocking Handle:** A large handle on the left side of the gun directly behind the feed. It is pulled back to cock gun which fires from open bolt, and then pushed forward to relieve the action of strain.

## LOADING AND FIRING

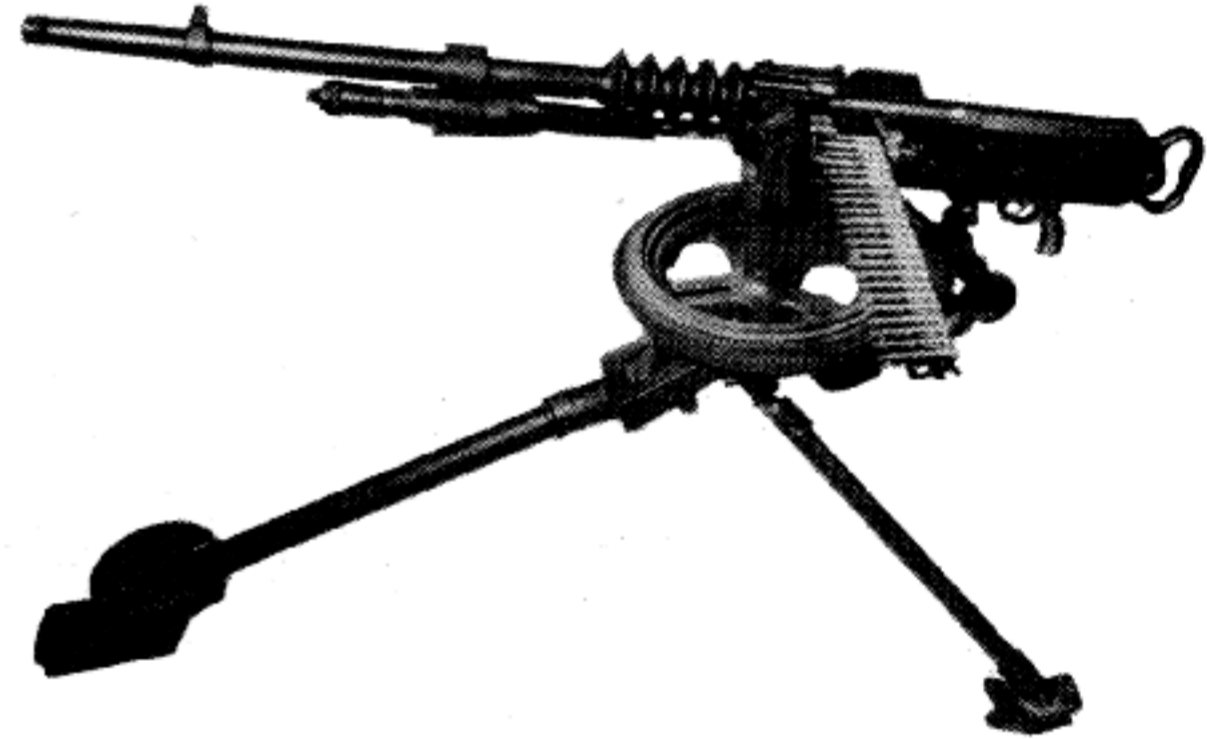

**Loading and Firing the Hotchkiss Gun:** 1. Pull cocking handle as far as it will go to the rear to compress recoil spring and cock gun. Bolt will stay open. Now insert cartridge strip in heavy brass feed block on left side of gun and push in as far as it will go. **Be sure that all cartridges are properly lined up in the strip.** This feed is very susceptible to jams.

2. Pressing trigger in trigger guard below frame will now fire the weapon. The gun will fire as long as there are cartridges in the strip and trigger is held back.



# FRENCH 1914 HOTCHKISS 8-MM MACHINE GUN

## FIELD STRIPPING



1. Unscrewing and pulling out the massive locking screw at the extreme rear left of the gun will permit the recoil spring and its guide to be pulled straight back together with the handle and attached top cover plate and they may be withdrawn from the gun. The working mechanism is now exposed.

2. The massive feed block can be driven out of its seat from the right hand side, pulled out **from the left side** of the gun.

3. The barrel can be removed from this gun when it gets too hot. This calls for a special spanner.

## HOW THE GUN WORKS

Starting with the gun loaded and cocked the action is as follows: 1. The trigger being pressed, the sear is permitted to free the breech lock which flies forward carrying with it the firing pin. The feed rib on the breech block strips the cartridge from the strip and feeds it into the firing chamber. As the bolt closes behind it, a hump on the under side of the piston which rides with the breech block comes into contact with the hinge link on the breech block, forcing the lower end of the link down into a recess where it engages in front of resistance shoulders on the body, locking the breech block securely. As this locking takes place, the striker pin is free to go forward and fire the cartridge in the chamber.

**Return Movement of the Action:** As the gas passes over the gas port, a small amount passes through the port and into the chamber where it expands against the head of the piston, driving it backward. Thus the bullet is well out of the barrel before the action starts to open. This rearward action of the piston raises the locking link away from the resistance shoulders, leaving the breech block free to be carried to the rear by the piston, while the empty cartridge case is gripped firmly by the extractor in the face of the breech block. The empty cartridge case strikes the ejector and is hurled out of the gun. If the trigger is released fast enough, the trigger and sear will engage to hold the weapon open. If the trigger is held depressed, the gun will continue to fire.

**Note:** This gun is still in use by the Japanese, though for first line service it has been replaced by improved Japanese versions of it (as well as by a large number of other types imitated by the Japanese).



# FRENCH CHATELLERAULT 7.5-MM 1924 MACHINE GUN

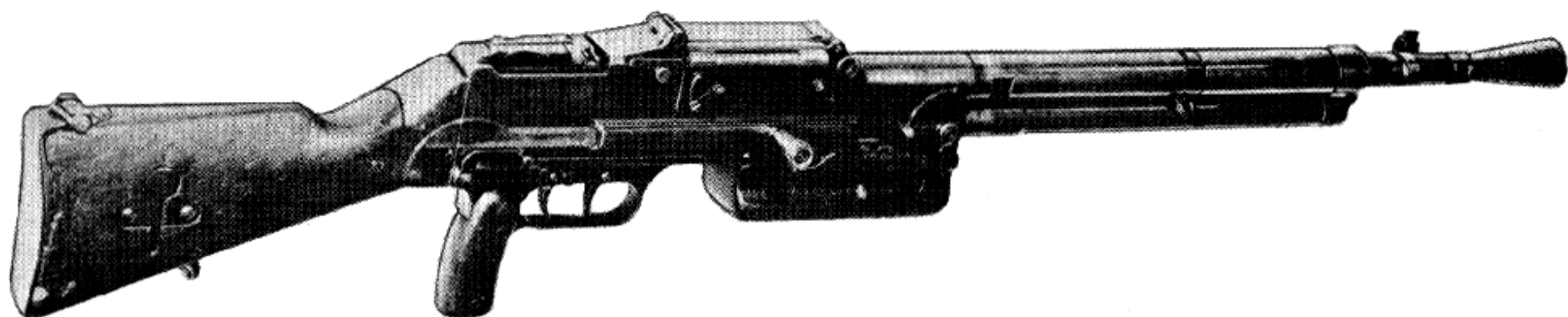

## (Fusil-Mitrailleur Modele 1924)

**Caliber:** 7.5mm French.

**Magazine:** Vertical box type, mounted on top of gun, holds 25 rimless cartridges.

**Barrel Length:** About 19 1/2".

**Weight:** Approximately 20 lbs. with bipod mounting.

**Mounting:** Bipod type attached to the barrel. Legs fold to the rear.

**Sights:** Adjustable foresight on left side of barrel. Radial rear sight on receiver.

**Gun Operated by:** Gas. Gas escapes through port into cylinder where it strikes against a piston head forcing piston back, compressing spring and opening the action.

**Locked:** Breech block securely locked during moment of high pressure by a rising type of bolt locking in shoulder in top of receiver.

**Cooled:** Air cooled. Gun has heavy barrel casing.

**Cyclic Rate of Fire:** 450 rounds per minute if special slowing device is used; 650 per minute if device is not used.

**Type of Fire:** Single shot on first trigger or full automatic on second trigger.

**Position of Bolt When in Firing Position:** Open. When trigger is released entire bolt and operating mechanism will go forward.

**Ejection Port:** On right side of receiver.

## LOADING AND FIRING

1. A loaded magazine is inserted vertically in the top of the gun. The magazine opening is fitted with a dust cover which must be hinged up and forward to expose the magazine opening. The magazine release catch is positioned at the rear opening. Pressing it forward will release the magazine to be lifted out with the hand which is operating the catch.

2. Pull back the cocking handle to cock the weapon and compress the mainspring. Safety lever on the trigger guard may be used to lock the weapon in this position.

3. If front trigger is pulled, pressure will be exerted on the sear to release the bolt to fly forward and fire the cartridge stripped out of the magazine by the bolt in its forward travel. If the second trigger is pulled, the sear will not engage as long as the trigger is held back, and the weapon will continue to fire full automatic.

## FIELD STRIPPING

### CARACTÉRISTIQUES

1. Le fusil-mitrailleur mod. 1924 est une arme à tir automatique fonctionnant par emprunt de gaz en un point du canon.

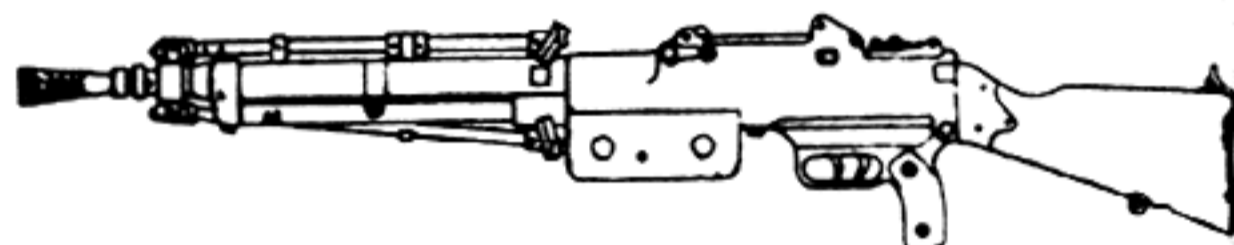

Fig. 1. — Côté gauche de l'arme.

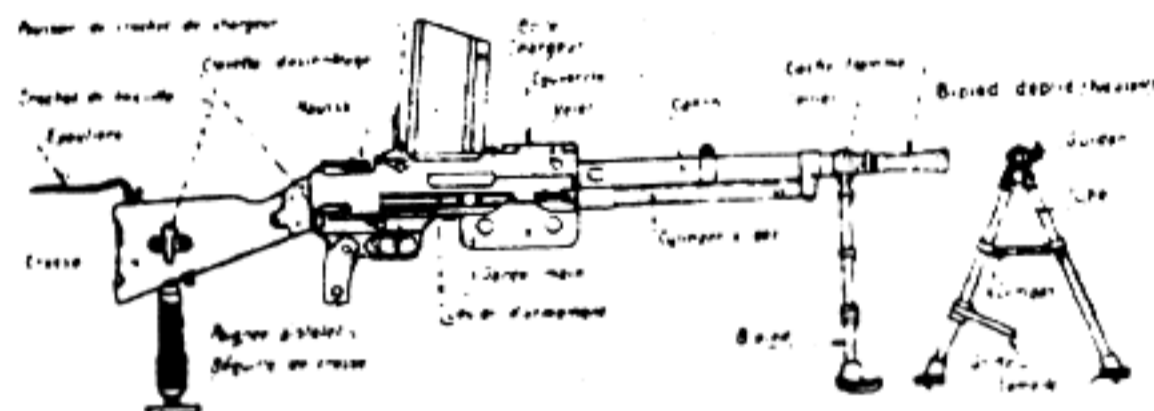

Fig. 2. — Côté droit, l'arme prêt à faire feu.

2. Il tire la cartouche mod. 1924 C, à balle légère, du calibre de 7mm 5. L'alimentation se fait à l'aide de boîtes-chargeurs dont la capacité est de 25 cartouches.

1. At lower right side of receiver is a retaining pin. Remove it; this permits the rear of the buttstock to be hinged **up and back**, when it can be lifted out of receiver.

2. Trigger guard assembly will now swing forward on hinge. Pushing first in, then out, unhook front end and remove.

3. Pulling head of ejector out of its slot will permit it to be removed from the rear.

4. Withdraw bolt and piston with slide out of receiver.

5. Gas cylinder tube lock is at lower front of receiver. Turn it to "O" mark on receiver, then raise **rear end** of tube. Tube can now be pulled out of receiver.

6. Barrel lock is on upper front of receiver. Turn it to "O" and unscrew barrel to **right**.



# FRENCH CHATELLERAULT 7.5-MM 1924 MACHINE GUN

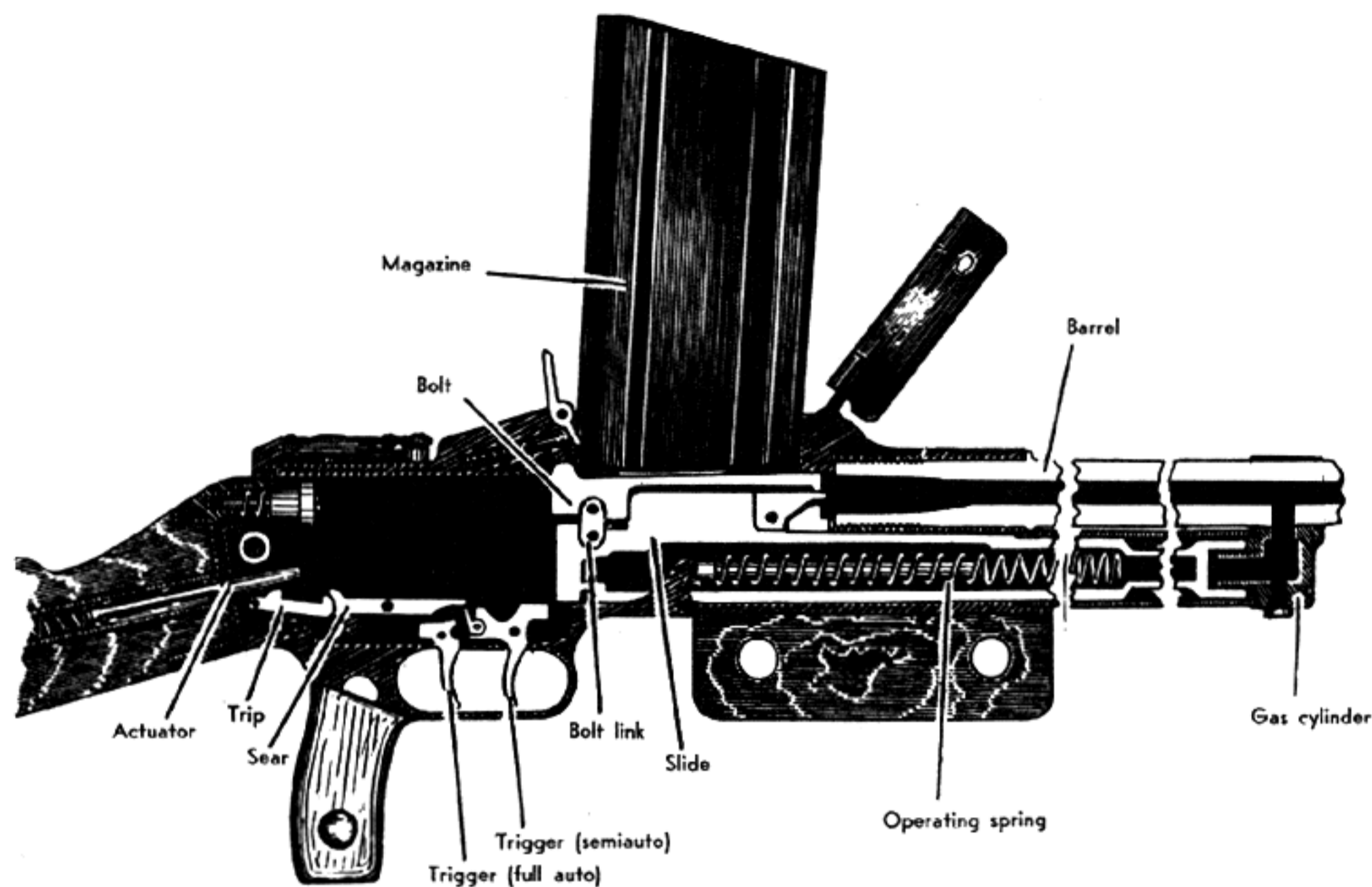

## HOW THE GUN WORKS

Starting with the gun loaded and cocked the action is as follows: If the first trigger is pulled, it pushes up the forward tip of the sear, bending down the rear end against the tension of the sear spring and pulling it out of the bent in the slide. The slide carries the striker in the front of its face. The slide and piston form a single unit; the bolt is fastened by a swinging link pin to the rear end of the slide. As the slide goes forward, pulled by the compressed recoil spring, carrying the moving components with it, the feed rib on top of the bolt passes between the lips of the magazine and strips a cartridge out. The extractor is forced over the base of the cartridge by the magazine spring, bringing the cartridge to proper feeding position in the bolt face.

As the forward motion nears its completion, the front end of the bolt stops against an abutment in the receiver. The rear end of the bolt, fastened on a rotating link to the slide, is now lifted up as the forward-moving slide rotates the link about the pins, and locks firmly in locking recess in the top of the receiver (somewhat like the Browning Automatic Rifle).

The slide, which carries the striker, continues to move ahead during the period of link rotation and the pin passes through its hole in the face of the bolt and strikes the cartridge now locked in the firing chamber.

### RETURN MOVEMENT OF THE ACTION

Gas escaping through the port as the bullet passes over it (a short distance from the muzzle) passes through the gas cylinder and expands violently against the cup end of the piston in standard Hotchkiss fashion. As the piston starts back under the impact of the thrust, the

gas escapes through slots in the gas cylinder tube. The piston, slide and link go back while the bolt is still securely locked.

Then as the dangerous period of pressure is passed, the rearward moving slide pulling on the bottom of the swinging link rotates it down, drawing with it the locked rear end of the bolt. As the movement continues, the bolt moves back in straight line with the other parts, carrying the empty cartridge case in the extractor. This case strikes the ejector and is expelled from the gun.

In semi-automatic fire, the rearward movement is completed as the end of the slide strikes the buffer sear release attached to the sear mechanism, causing a rebounding action which catches the sear in the slide to hold it back; while the back end of the bolt strikes the buffer which absorbs shock through a coil spring. In automatic fire, of course, the sear cannot engage; and the slide goes forward immediately.

An interesting development in this weapon is an actuator in the buttstock which can be used to check the rate of fire.

A plunger rod rides in a tube with a spring behind the rod. The front end of this rod passes through a hole into the receiver in line with the slide, and touches a sear trip attached to the sear mechanism. This device acts as an escapement to cause a definite hesitation between shots, as the sear is held in engagement longer than usual.

The rate of reduction is considerable. In theory, the higher speed is used in firing against aircraft; while the slower speed is used in ground work.



# GERMAN LUGER (PARABELLUM) 9-MM 08 AUTOMATIC

(Called Luger in U. S.; and Parabellum in Europe)

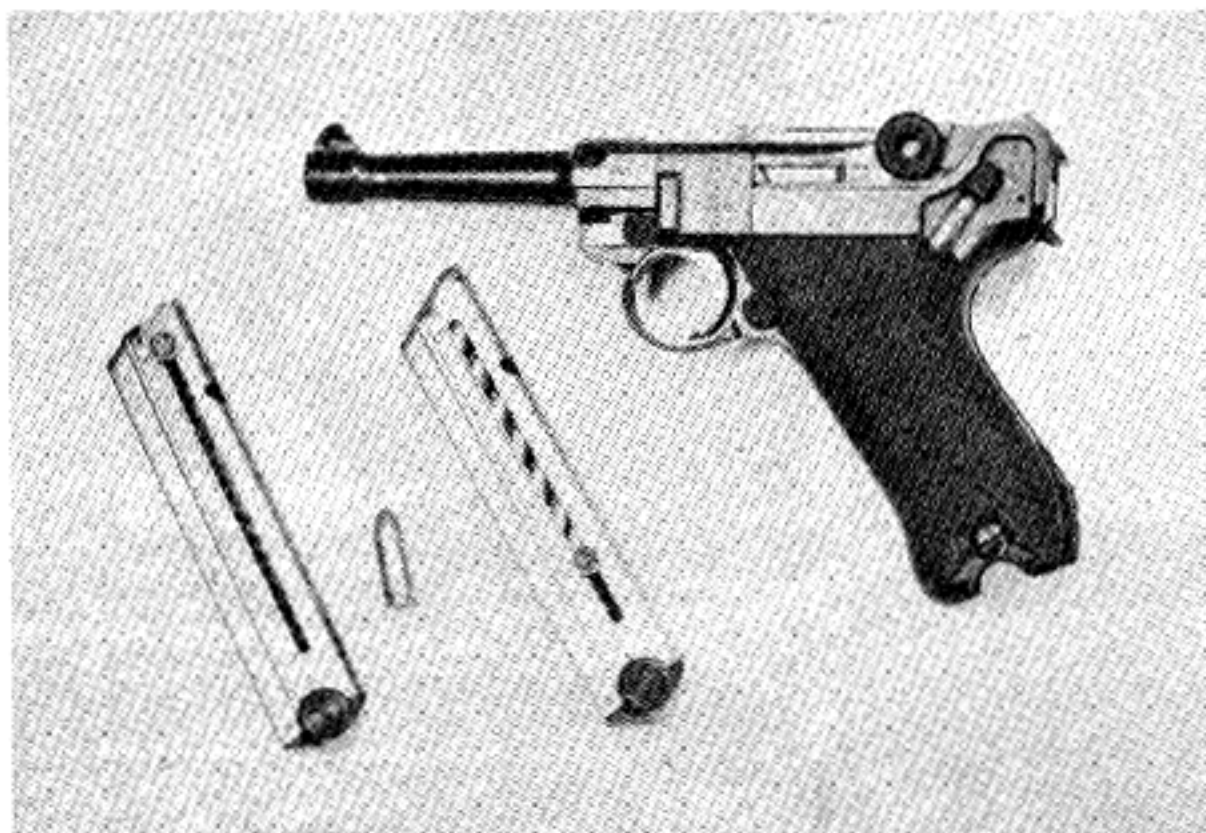

**Caliber:** 9mm Ball Ammunition, flat point or round point. (Cal. 35)

**Magazine:** Box type, single line, capacity 7 cartridges. Note: magazine follower is fitted with special sliding stud to permit easy loading of magazine.

**Muzzle Velocity:** 1040 to 1500 feet per second. Note: The customary M.V. of the German manufactured ammunition is 1040 F.P.S. but cartridges for this weapon are manufactured in the United States with a M.V. of 1150 F.P.S.; while German ammunition manufactured specifically for machine pistols but, usable in the Luger, develop 1500 F.P.S.

**Weight of Bullet:** 125 grains, lead with metal jacket, or lead with steel jacket. Note: High velocity cartridges are loaded with steel jacketed bullets and used for semi-armor piercing purposes.

**Muzzle Striking Energy:** 320 to 460 Foot Pound (365 with U. S. Ammunition).

**Barrel Length:** 4" Note: Special 6", 8" and 10" barrels are provided for special purpose weapons.

**Overall Length of Pistol:** 8 $\frac{3}{4}$ "

**Weight of Pistol:** 30 oz.

**Sights:** Inverted "V" blade front sight; open "V" notch rear sight. Fixed.

**Accurate Range:** About 75 yards.

**Maximum Range:** About 1200 yards with lowest powered cartridges.

**Pistol Operated by:** Recoil.

**Locked:** By Maxim-type toggle joint.

**Type of Fire:** Single shot only.

**Magazine Release Catch:** Button on left side, similar to Colt .45 Automatic.

**Position of Breech When Last Shot Is Fired:** Open. Toggle joints are buckled up.

**Safety:** Thumb piece on upper left hand side of receiver. To apply this Safety, pull **back** and **down**. The German word "Gesichert" is now exposed. To fire pistol, push this catch **up** and **forward**.

**Special Features:** When the firing chamber is loaded, the extractor rises above the base of the breech block exposing the word "Geladen," indicating loaded.

**Special Note:** While the 9mm is the official German Army caliber, this weapon may be found in 30 caliber (7.65mm). This model shoots a bottle necked cartridge with a 93-grain bullet, developing a M.V. of 1250 feet per second and a striking energy of 323 foot pounds. Magazine capacity of this caliber is 8 cartridges. It is manufactured in barrel lengths ranging from 3 $\frac{3}{4}$ " to as much as 16".

## INSTRUCTIONS FOR LOADING AND FIRING LUGER PISTOLS



1. To extract magazine: Press magazine release stud near trigger on left hand side and withdraw magazine from butt of pistol.

2. To load magazine: Hold magazine firmly in left hand. Pull down stud attached to magazine platform. This will compress



spring and permit cartridges to be dropped into the magazine.

3. To load firing chamber: (a) Holding pistol pointed down towards ground with right hand, grip the milled knobs on the toggle and pull up and back as far as the breechblock will go. This compresses the

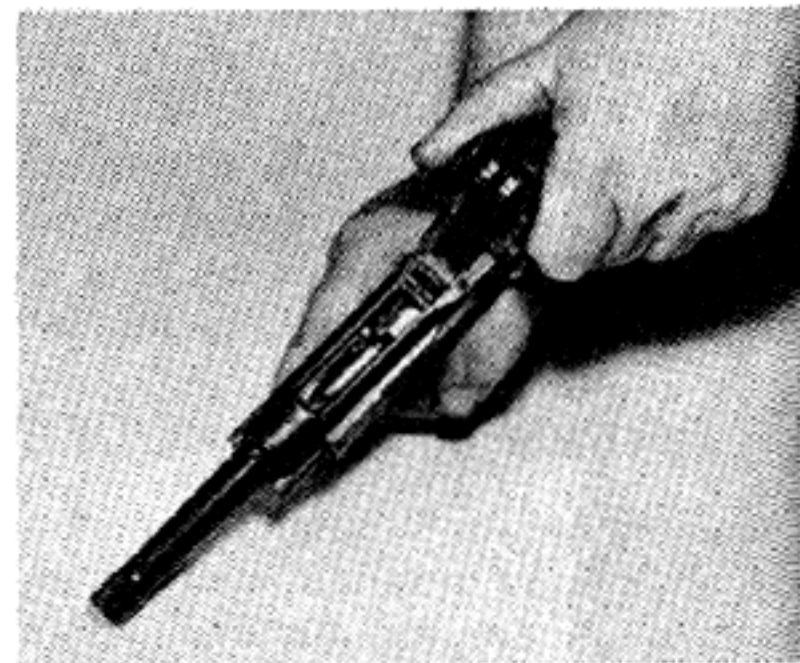

recoil spring in the grip and permits the first cartridge in the magazine to rise in line with the breechblock. (b) Release grip and spring will force breechblock back into locked position driving a cartridge into the firing chamber.



# GERMAN LUGER (PARABELLUM) 9-MM 08 AUTOMATIC



4. **To set thumb safety:** Pull thumb piece back and down. This will expose the German word "Gesichert," "Made safe." At the same time a flat solid steel piece will be seen to rise directly in front of the milled knob on the toggle. This locks the sear so the weapon cannot be fired.

5. **Breech Block Stop:** When the last cartridge has been fired, the stud of the

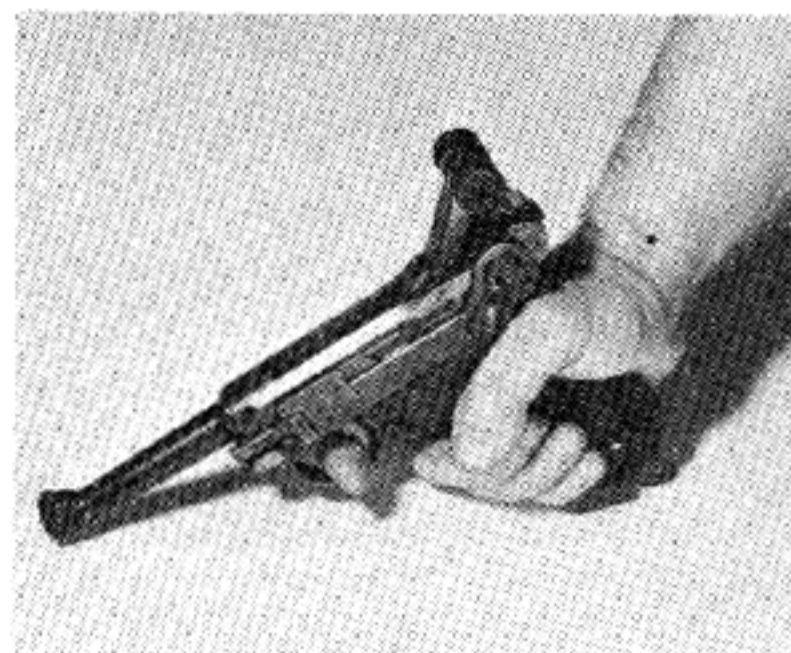

magazine follower will force the catch up and hold the breech open with toggle joint buckled.

6. **Reloading from open breech:** (a) Extract empty magazine. (b) Replace with loaded magazine. (c) Pull back on milled surfaces and permit breech block to drive forward loading firing chamber.

## FIELD STRIPPING

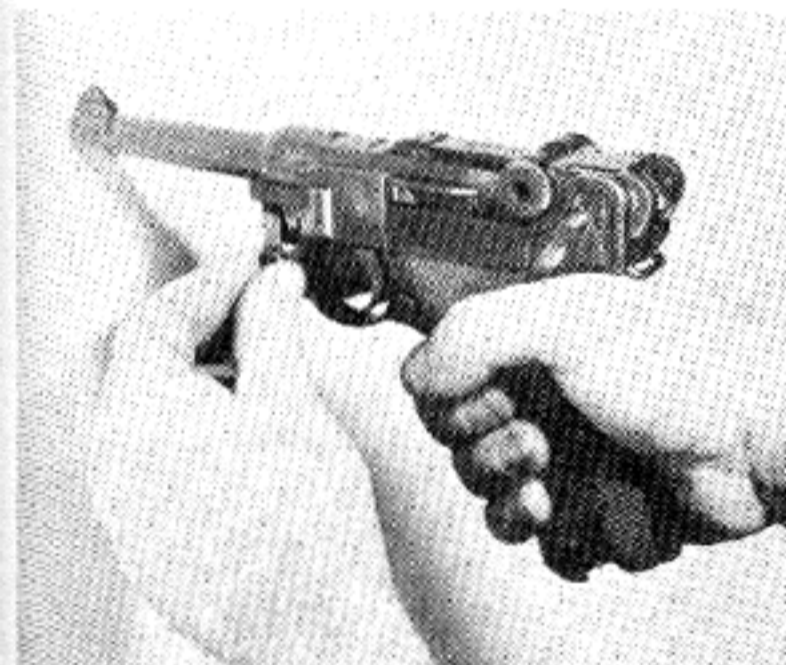

1. Holding pistol in right hand press muzzle down firmly on a hard surface about  $\frac{1}{2}$  inch to release tension on the recoil spring. With the tension removed, the thumb catch on the side plate may now be turned down to a vertical position.

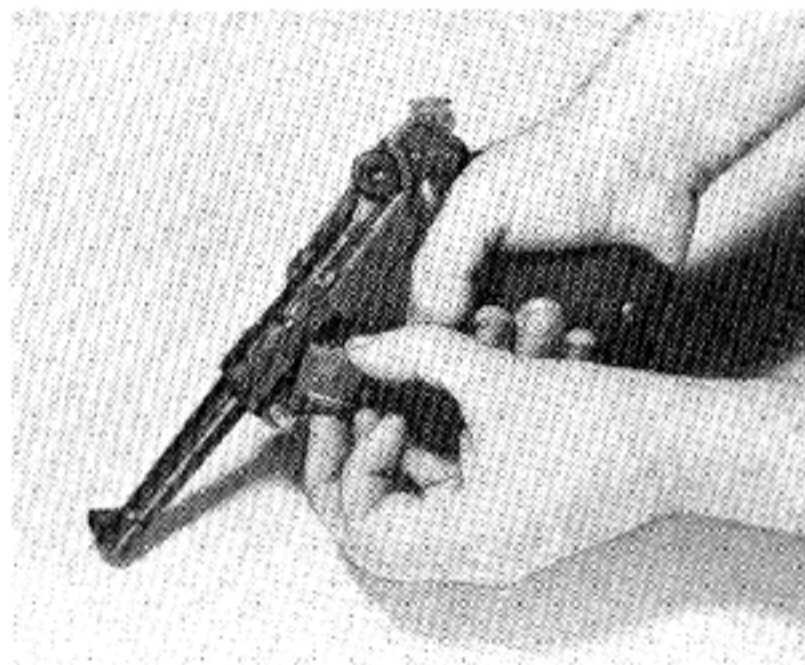

2. Now lift out the side plate.



3. Slide the complete barrel and toggle assembly directly to the front and out of the receiver.

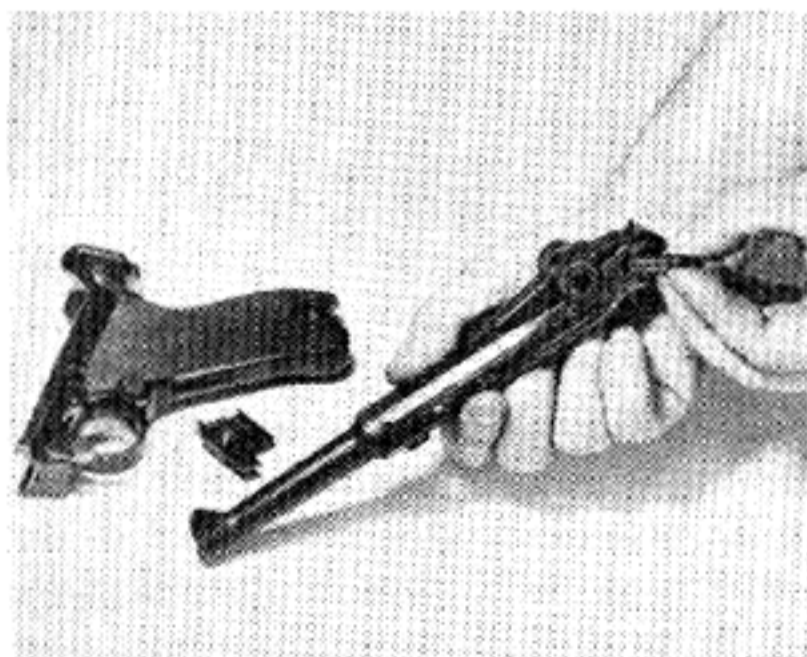

4. Buckle the toggle slightly to relieve tension and extract retaining pin on the left hand side.

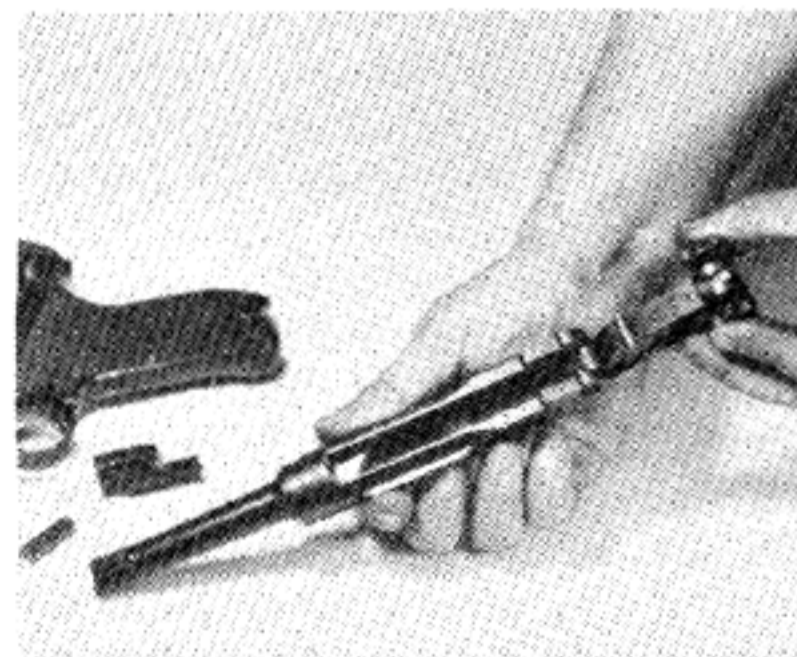

5. Now pull toggle assembly, breech block containing firing pin and extractor directly back in their guide and out of the frame. No further dismounting is necessary or recommended.

## NOTE ON REASSEMBLING

Merely reverse stripping procedure. Take care hook suspended from rear of the Toggle Assembly drops into proper place, which is in front of the inclined ramps. Also note that when replacing the side plate, the tongue

on the rear end must be inserted in the recess in the receiver and the projecting section of the trigger bar must fall into the proper slot at the top of the trigger.



# GERMAN LUGER (PARABELLUM) 9-MM 08 AUTOMATIC

## HOW THE PISTOL (LUGER) 08 WORKS

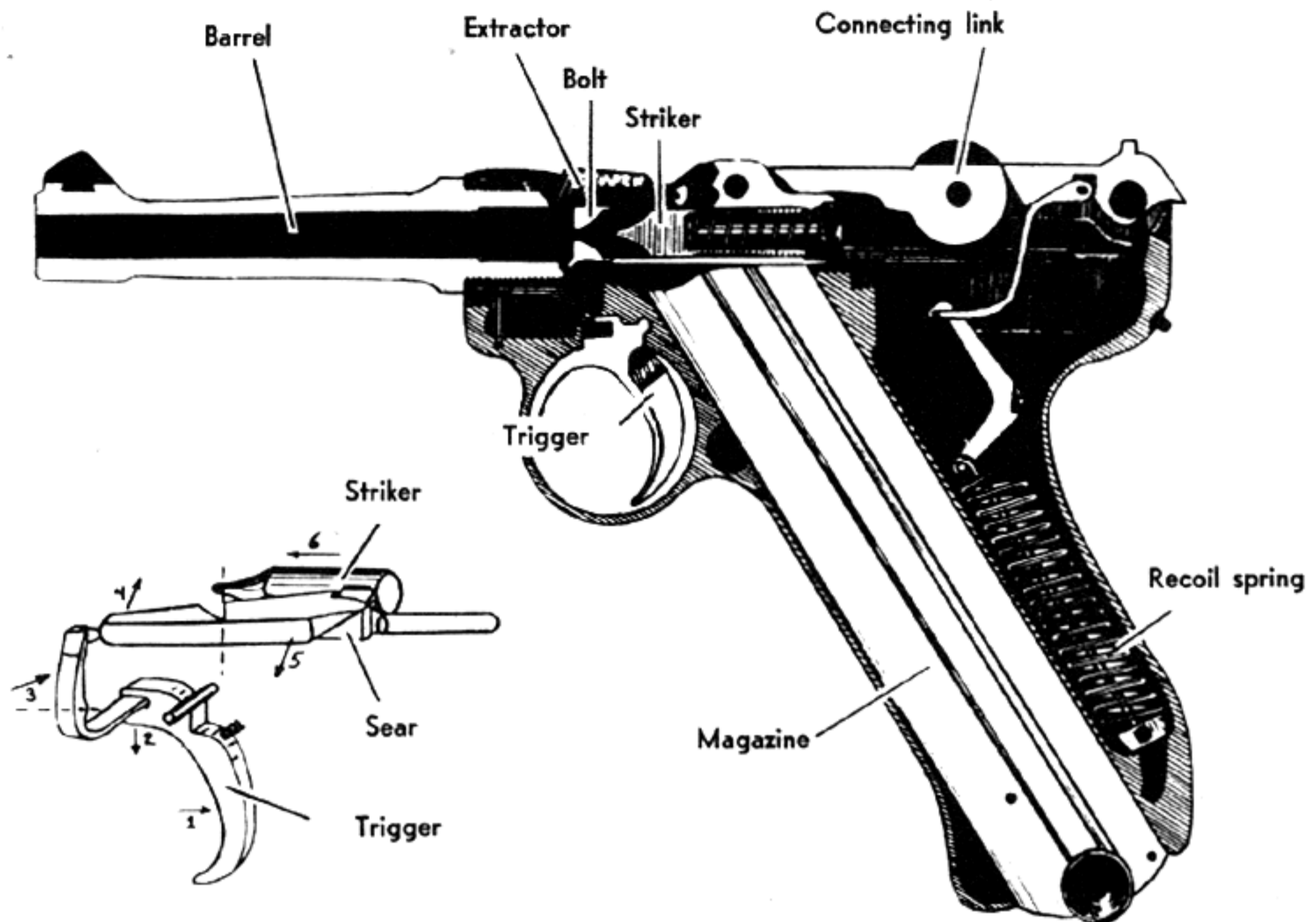

Starting with the Pistol Loaded and Cocked, the action is as follows: The trigger being pressed, a connecting piece forces back a pin which presses out a spring-retaining lock permitting the striker to go forward and fire the cartridge in the chamber. (The involved trigger system of this pistol is one of its greatest weaknesses.) As the bullet goes forward down the barrel, the barrel and the recoiling mechanism locked together move backwards about half an inch. There is a toggle joint behind the breechblock which functions exactly as a human knee. A strong pin at the rear fastens this toggle securely to the barrel extension. At the point where the breech pressure has dropped to safe limits, the center part of this toggle joint strikes against a sloping part of the frame, buckling the toggle exactly as a human knee; but continuing to draw the breech block in a direct line in its guide in the barrel extension. During this opening movement a short coil spring, which drives the firing pin and is situated inside the breech block is compressed and caught and held by the sear. The extractor, fitted in the top front of the breech block pulls the empty cartridge case back until it strikes an ejector piece and is hurled out of the pistol. A small coil spring snaps the extractor back into place. As the toggle joint buckles upward, a hook lever hanging from its pin and hooked under claws attached to the recoil spring in the grip, compresses the recoil spring, storing up energy for the return movement of the action. The magazine spring forces a cartridge up into line with the breech block. An abutment at rear of receiver is struck by the rear edge of the buckled toggle, stopping further travel. The rearward motion is now complete.

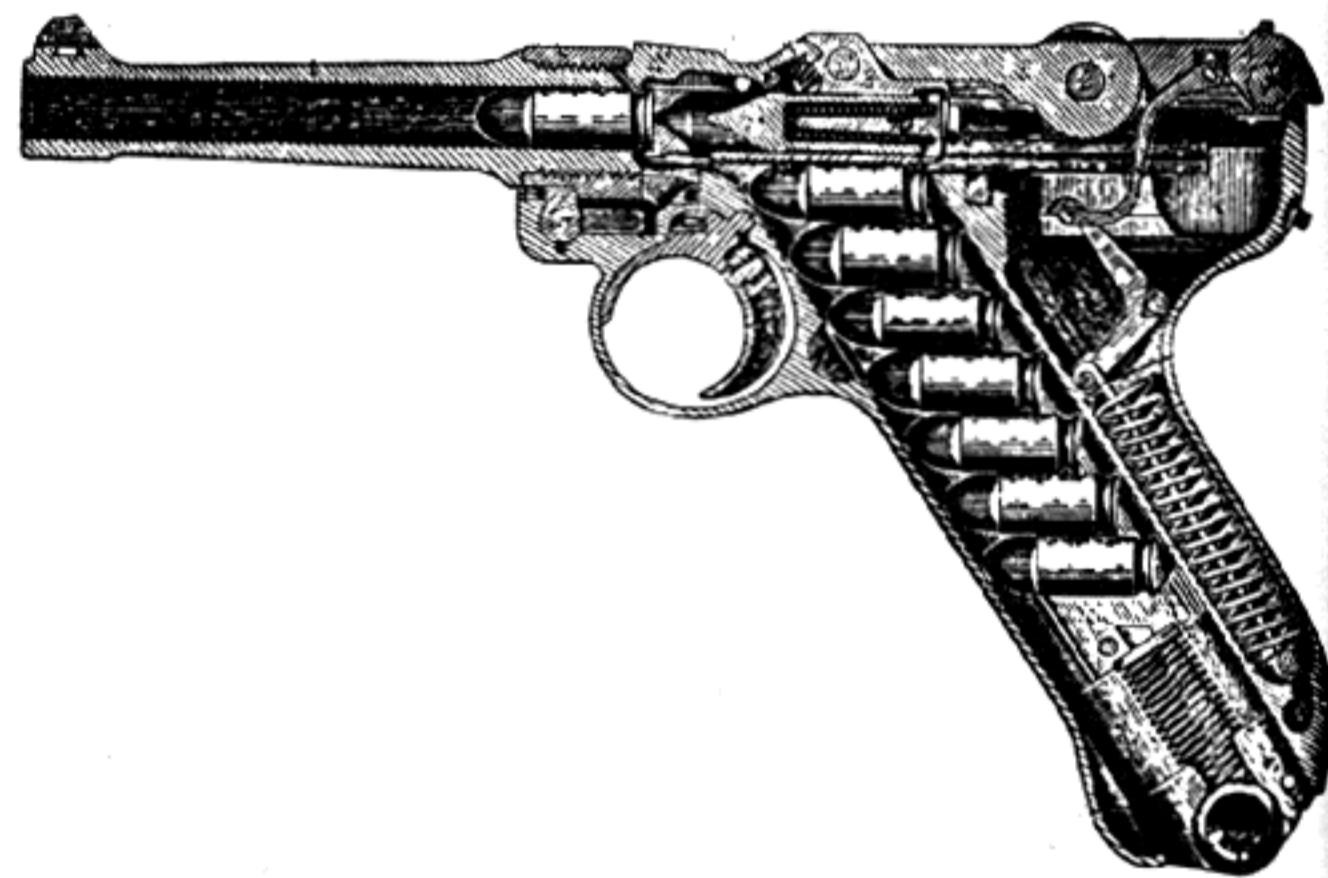

**Return Movement of the Action:** The compressed recoil spring pulls down against the hook lever drawing down the bent toggle exactly as a bent knee straightens out when one stands up. This forward action drives the attached breech block straight ahead in its guide; strips the top cartridge out of the magazine and into the firing chamber; extractor springs over the head of the cartridge and locks in the cannellure of the cartridge case (this raises the height of the extractor so that it is above the face of the breech block. Looking at the extractor—or touching it if in the dark—tells if the chamber is loaded). The breech block and the two levers of the toggle are now in a straight line and the axis of the toggle is slightly below the other axes. The pistol is thus securely locked. The sear now connects with the trigger mechanism; trigger spring pushes trigger into place; and pistol is ready for the next shot.



# GERMAN LUGER (PARABELLUM) 9-MM 08 AUTOMATIC

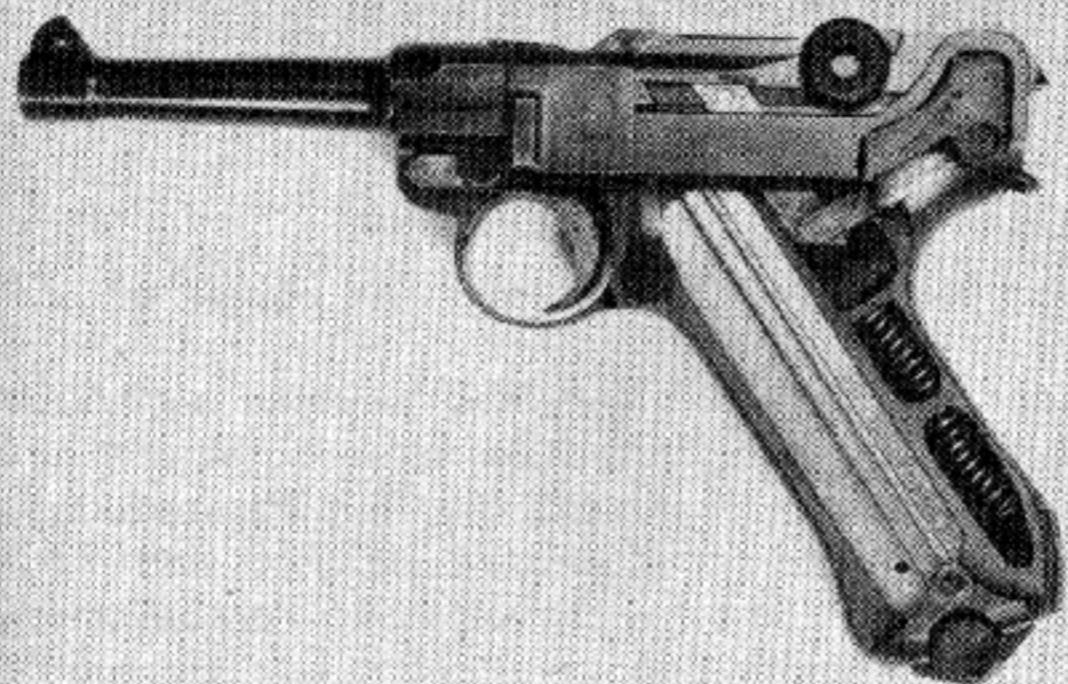

**How the Thumb Safety Works:** While the normal method of applying the thumb safety on this pistol is to push it **back** and **down**, there are models in which the procedure is the exact reverse. When the pistol is on



**safe**, a flat steel piece attached to thumb-piece is forced up out of the receiver on the left hand side just above the stock. This prevents the outward expansion of springs which lock the striker back in firing position.

## SPECIAL MODELS OF THE LUGER PISTOL



The customary Naval Model has a 6" barrel. Special Carbine models are issued with 8", 10", 12" and sometimes 16" barrels. Some of these have a wood fore-end and some do not. All are customarily issued with wood holsters which can be attached to the grip of the pistol to transform it into a carbine. These models are normally fitted with elevating rear sights capable of adjusting to 800 meters. (The model illustrated has an 8" barrel and

a carbine-type holster stock.)

A special 32-shot magazine is sometimes issued for these pistols. These are not in general use, having been largely supplanted by Machine Pistols. However, very large quantities of them were manufactured and doubtless will be encountered during the course of action abroad.

## TO LOAD SPECIAL 32-SHOT MAGAZINES

- A. Open the folding arm of the magazine.
- B. Turn to the right until the lever joint engages in the recess in upper section of drum parts. Load cartridges in through magazine opening and turn lever to wind spring **gradually** as cartridges are inserted.
- C. When drum is fully loaded, press the catch button at the center of the drum and the spring will be released to press against the cartridges and force them

around the drum and up the box magazine into the firing line. (Note: this magazine may also be used in the earlier models of the Bergmann Machine Pistols.)

**Note:** While this is a finely designed, superbly balanced pistol, it is not in a class with the U. S. Army service pistols for ruggedness or general reliability. In recognition of this fact, the Germans issue this pistol in a special heavy duty holster which covers the entire



# GERMAN LUGER (PARABELLUM) 9-MM 08 AUTOMATIC

length of the weapon enclosing it completely. A pocket for an extra magazine will be found inside this holster. Inside the flap is a small dismounting tool. By placing the hole of this tool over the stud of the magazine, and

pressing down on the projecting hook, a special lever is provided which makes loading the magazine much easier than if the spring is compressed entirely by the thumb and fingers.

## EXPLANATORY NOTE ON VARIOUS NAMES FOR GERMAN PISTOL 08

**Pistole 08:** This is the official German name for the weapon. When adopting a **basic** weapon in any class (rifle, pistol, submachine gun, etc.) the customary military policy is to identify it by YEAR OF ADOPTION. (Thus the Colt .45 Automatic is officially The Automatic Pistol, Cal. .45, Model 1911.) This system prevents confusion when a Nation finds it necessary to utilize **subsidiary** weapons in any given class during an emergency or test period.

**Luger Pistol:** This is the popular American name for the weapon. From the time of its original manufacture, this pistol has been a very popular one in the United States, particularly in Caliber .30 (7.65mm). Its excellent balance and hang, its high velocity and fine general performance made it the accepted favorite of many pistol enthusiasts. (As a military pistol it is generally conceded to be far inferior to the Colt.) Originally designed by a Connecticut Yankee named Borchardt, it was further developed by a German named Leuger and was first manufactured on a large scale under the name Borchardt-Leuger. This was later corrupted and shortened to the present name—"Luger." Under that name it has been widely sold throughout the world.

**Parabellum Pistol:** Literally this means "Pistol for War," and under the name Parabellum it has been widely adopted as a military pistol; while the term 9mm Parabellum cartridge has come to mean a cartridge of much

greater power than is necessary for pocket or civilian use.

Under the Treaty of Versailles, German and Austrian arms factories were forbidden to manufacture or sell pistols or revolvers of this military 9mm Parabellum type.

So instead they concentrated on 7.65 and 7.63mm weapons which could be converted to Parabellums with very little difficulty and on short notice by supplying 9mm barrels and magazines. The Luger is such a weapon—all parts except barrels can be used interchangeably in 7.65 and 9-mm types.

This trick was common knowledge in military and small arms circles almost from the day the policy was inaugurated. In 1929 the **Textbook of Small Arms** published by the British War Office said: "The German and Austrian factories have since (the Treaty of Versailles) produced a number of very well-designed simple and efficient selfloading pistols of .32-inch and 7.63mm. In many cases the dimensions of the new pistols are such that they will accommodate a 9mm barrel and magazine without material alteration of the manufacturing plant."

Unfortunately, very little attention was paid to military experts during the years when Germany was making such preparations (as well as using Swiss, Danish and Belgian factories for experimental work on arms.) Today we are paying the price for that lack of attention.



# GERMAN MAUSER 7.65-MM (32 CAP) AUTOMATIC

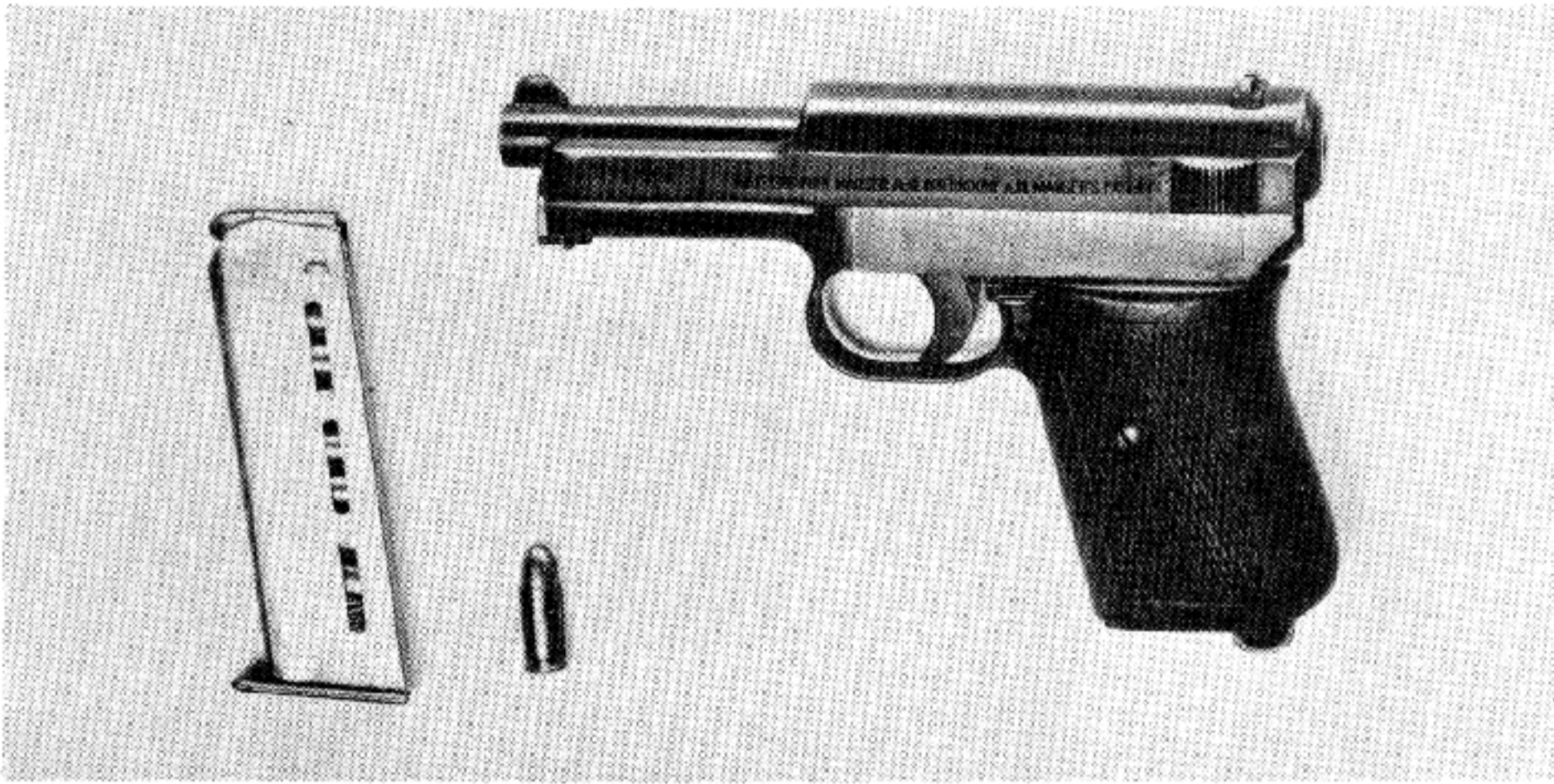

This pistol requires a fuller description than most of the small pocket type pistols found in military use, because of its widespread popularity throughout Europe, and because it has several features which make it dan-

gerous to handle unless the pistol is understood.

1. Magazine catch is in the bottom of the butt and must be pushed back to release the magazine. Magazine will hold 8 cartridges.

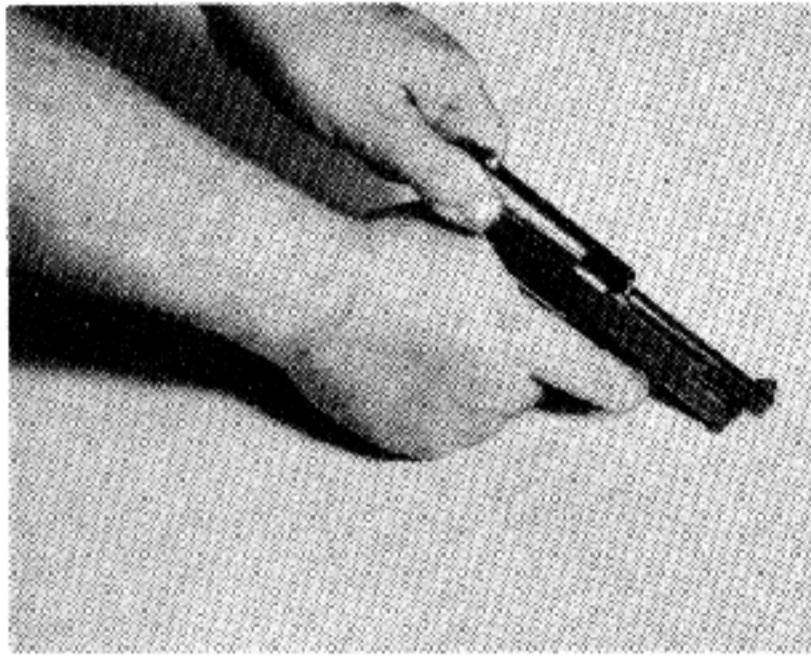

2. When loaded magazine has been inserted in handle, slide is drawn fully to the rear exactly as in the case of the Colt automatic pistol and then permitted to run forward under the influence of the compressed recoil spring. The indicator pin protrudes from the rear of the breech block when the pistol is cocked, giving warning that weapon is dangerous.

3. Safety: Pressing down on the milled thumb catch on the left side of the pistol just back of the trigger, sets the pistol at "safe." To release this safety, press in the **small button** directly **below** the thumb piece.

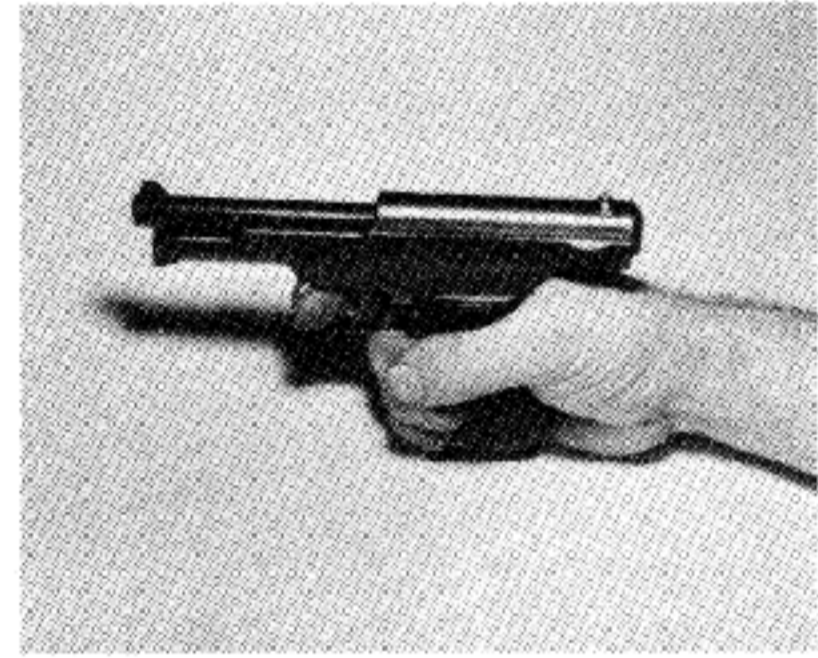

4. **Warning:** When the action is open and a magazine **whether loaded or unloaded** is inserted into the handle, the slide runs home **immediately upon the magazine being seated**. Should your finger be on the trigger when this slide goes forward unexpectedly, a cartridge may be fired. On the other hand, if the chamber is loaded, but there is no magazine in the handle, the trigger **cannot** be pulled. This feature acts as a safety.

## KEY

1. Barrel.
2. Barrel Retainer.
4. Striker.
5. Striker Spring.
7. Interceptor.
10. Breech Cover (or Slide).
11. Recoil Spring.
12. Ejector.
13. Double Action Spring.
16. Magazine.
17. Trigger.
21. Safety lock spring.
24. Trigger Catch.
27. Sear.
- e. Thumb Safety Bar.
- f. Safety Pivot Pin.
- h. Safety Release Button.

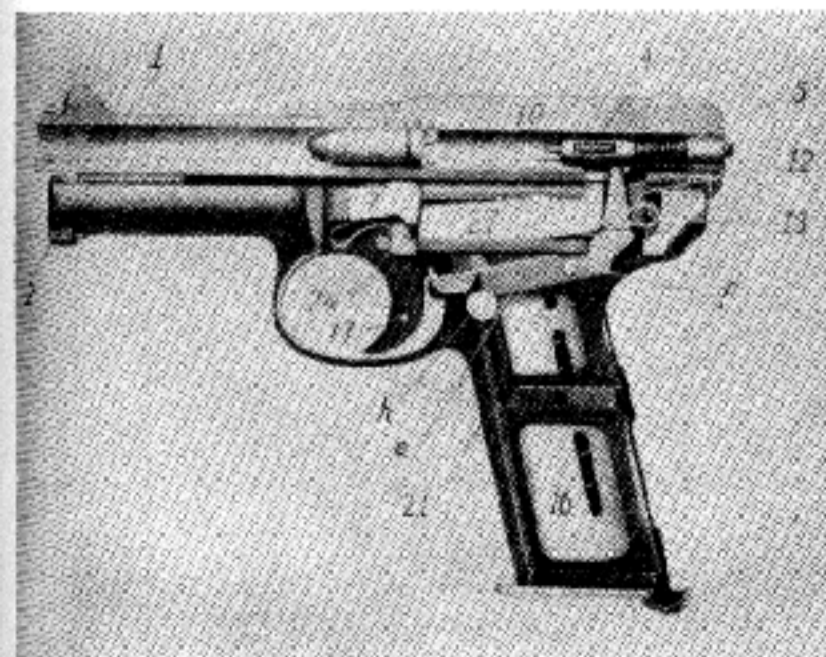

Safety in Position and Chamber Loaded.

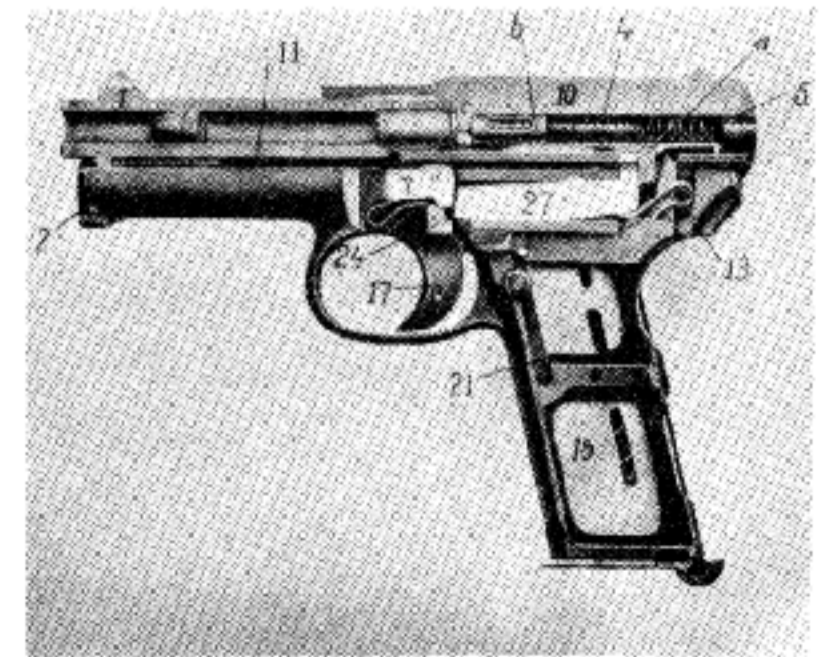

Pistol Fired, Parts Still Locked.



# GERMAN MAUSER 7.63-MM AUTOMATIC

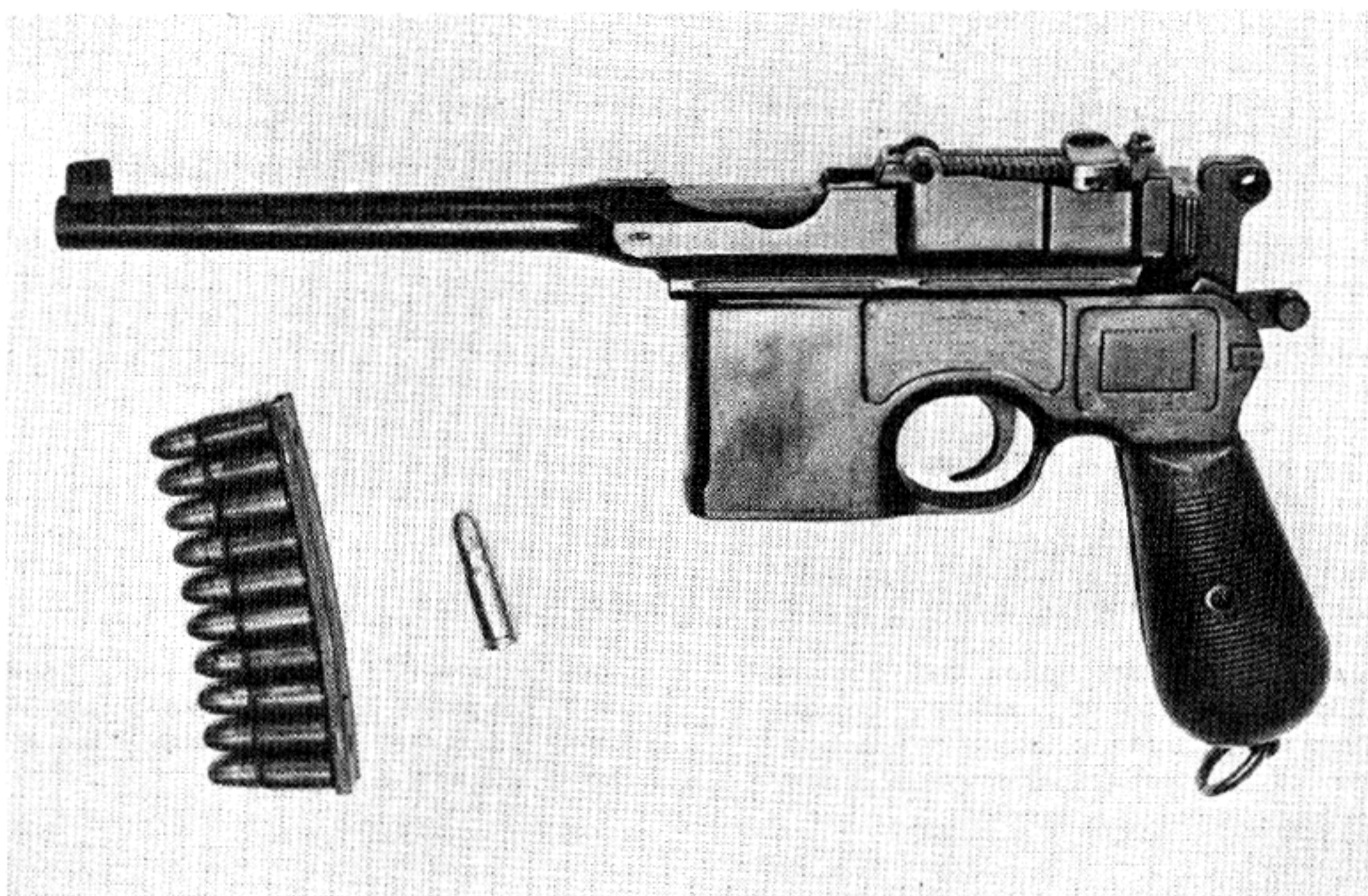

**Caliber:** 7.63mm

**Magazine:** Fixed-box type in front of trigger guard. Loaded by clips stripped in from top.

**Magazine Capacity:** 10 cartridges.

**Muzzle Velocity:** 1420 feet per second with standard manufactured U. S. ammunition. From 1320 to 1600 feet per second with varying types of German ammunition.

**Muzzle Striking Energy:** With U. S. manufactured ammunition, 380 foot pounds with metal jacketed bullets; and 400 foot pounds with soft point bullet.

**Barrel Length:** 5 $\frac{1}{4}$ ".

**Overall Length of Pistol:** About 12".

**Weight of Pistol:** 45 ozs.

**Sights:** Fixed front sight. Rear sight adjustable for elevation, graduated from 50 to 1000 meters.

**Accurate Range:** As a pistol, 75 yards. With shoulder stock attached, 1000 yards (1800 meters extreme range).

**Pistol Operated by:** Recoil.

**Locked:** By link forced up from below engaging in locking recess on under surface of bolt. Bolt and barrel are thus locked together until bullet has left barrel and sliding members have recoiled about 3/16".

**Type of Fire:** Single shot only. Trigger does not engage with hammer release mechanism until bolt is locked firmly in forward position.

**Safeties:** (a) There is a heavy thumb catch on the left side of the pistol near the hammer. When this is **horizontal** the pistol may be cocked and fired. When it is pushed **up** as far as it will go the pistol is on "Safe." (b) As in automatic pistols generally, this weapon is fitted with an **automatic disconnecter** which prevents more than one shot being fired at each pull of the trigger.

## LOADING AND FIRING

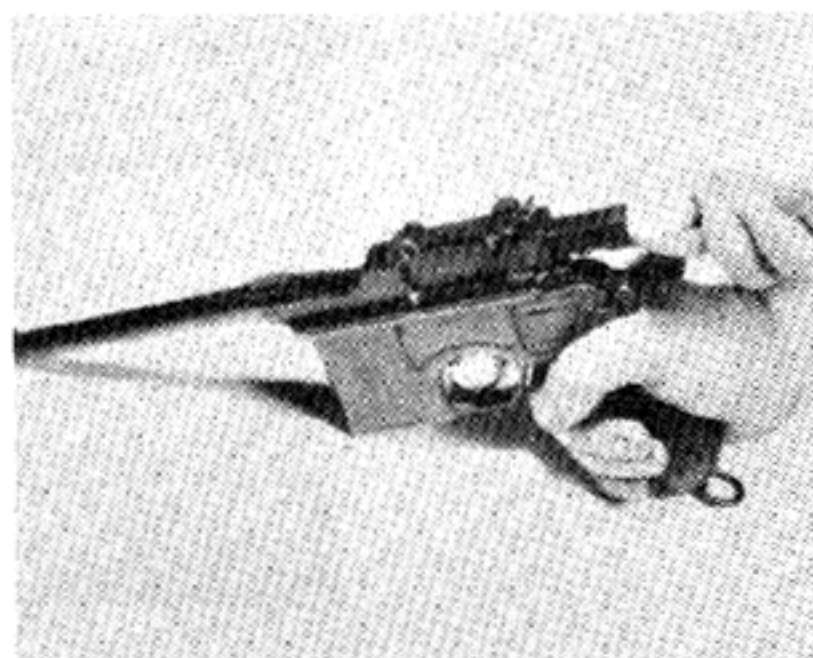

1. Grasp bolt wings firmly and draw bolt straight to the rear as far as it will go. The magazine follower will rise and hold the bolt open.

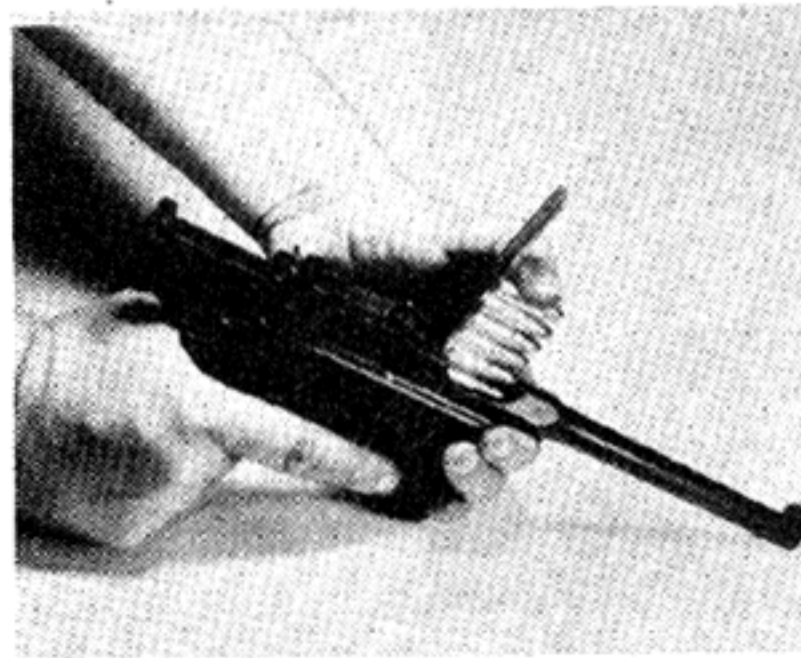

2. Now insert a loaded clip in the clip guide directly in front of the rear sight. Exert firm even pressure with thumb and strip cartridges down into the magazine.



# GERMAN MAUSER 7.63-MM AUTOMATIC

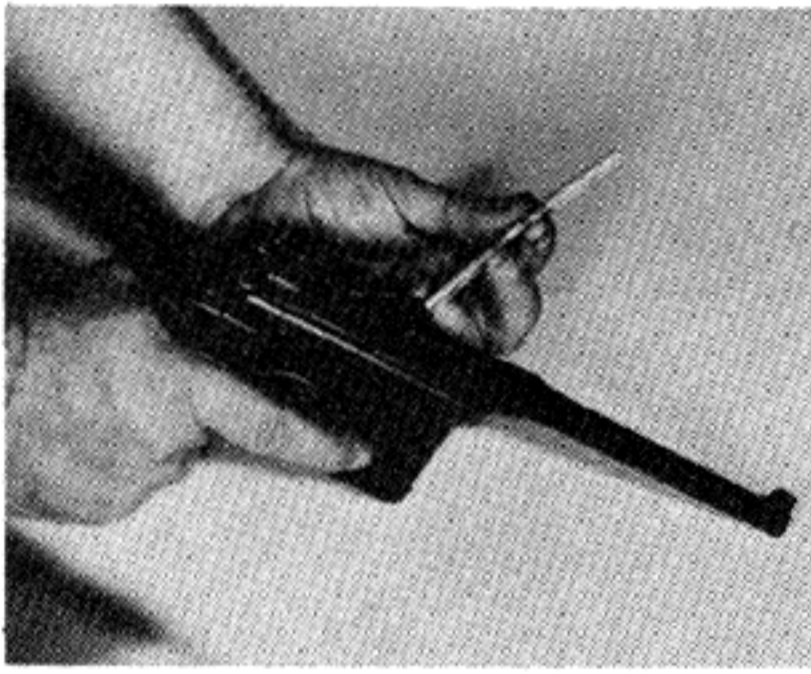

3. Now pull clip straight up out of pistol. The bolt will run forward and load the firing chamber the instant the clip is withdrawn.

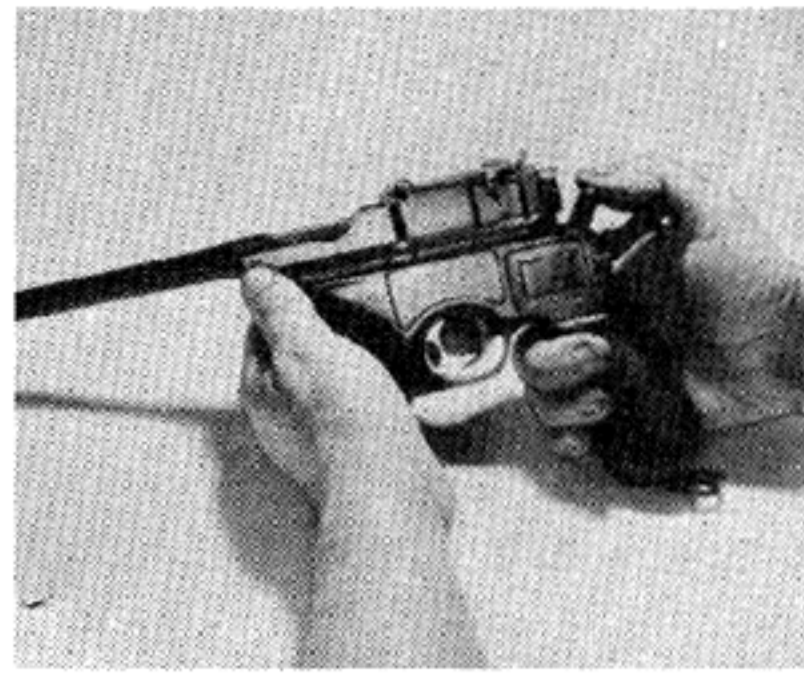

4. Unless pistol is to be fired immediately, set the thumb safety by rocking it forward as far as it will go. Thumb safety may be easily released by pulling back slightly on hammer and tilting pistol up and back.

## FIELD STRIPPING

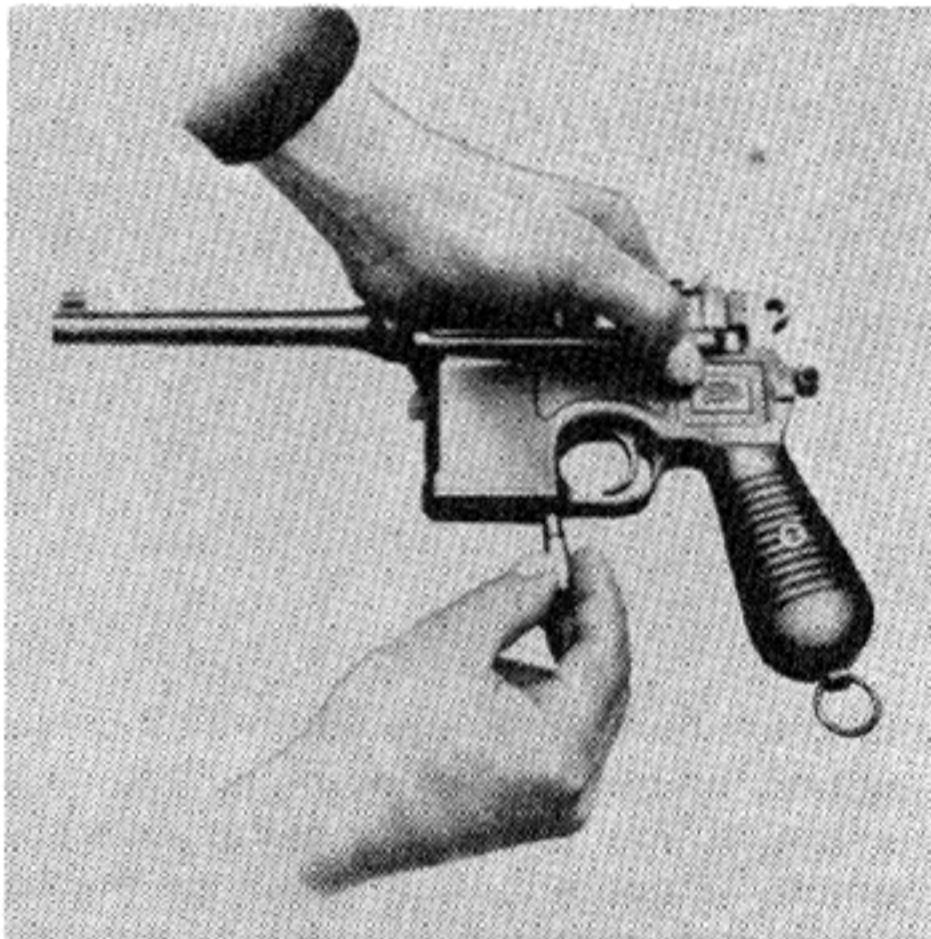

1. To dismount magazine: Insert nose of a bullet in hole in magazine base plate and push up lock stud. With tension thus removed, slide plate forward slightly. It may now be eased out together with magazine spring and magazine follower.

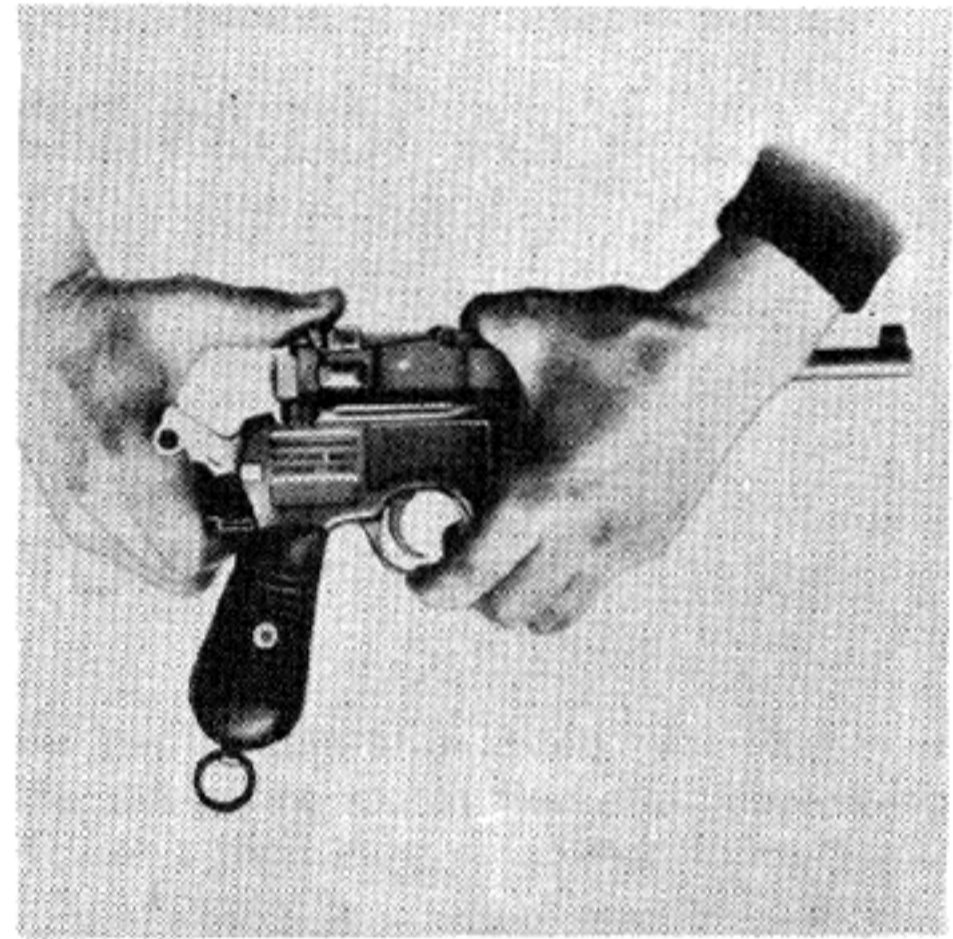

2. Cock the hammer. Use a cartridge clip, or screw driver, press up the catch just below the base of the hammer and pull back barrel.



3. Now withdraw barrel, barrel extension and hammer mechanism clear of the receiver.

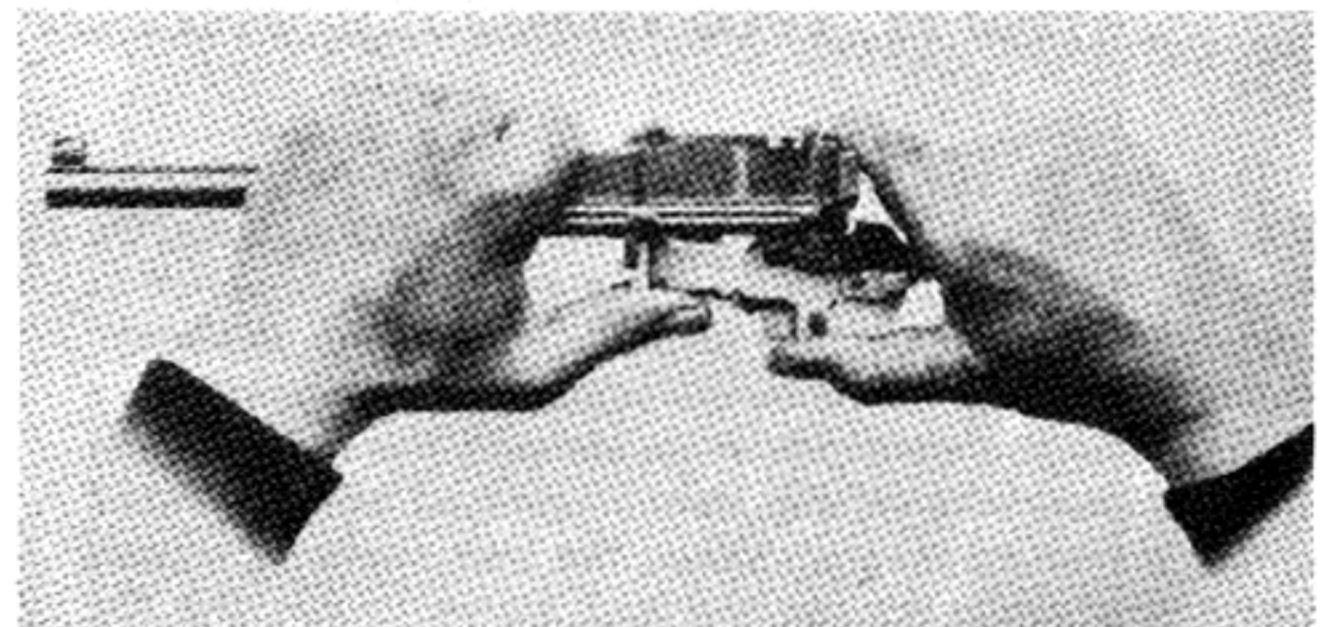

4. Lift hammer mechanism out of barrel extension.



# GERMAN MAUSER 7.63-MM AUTOMATIC

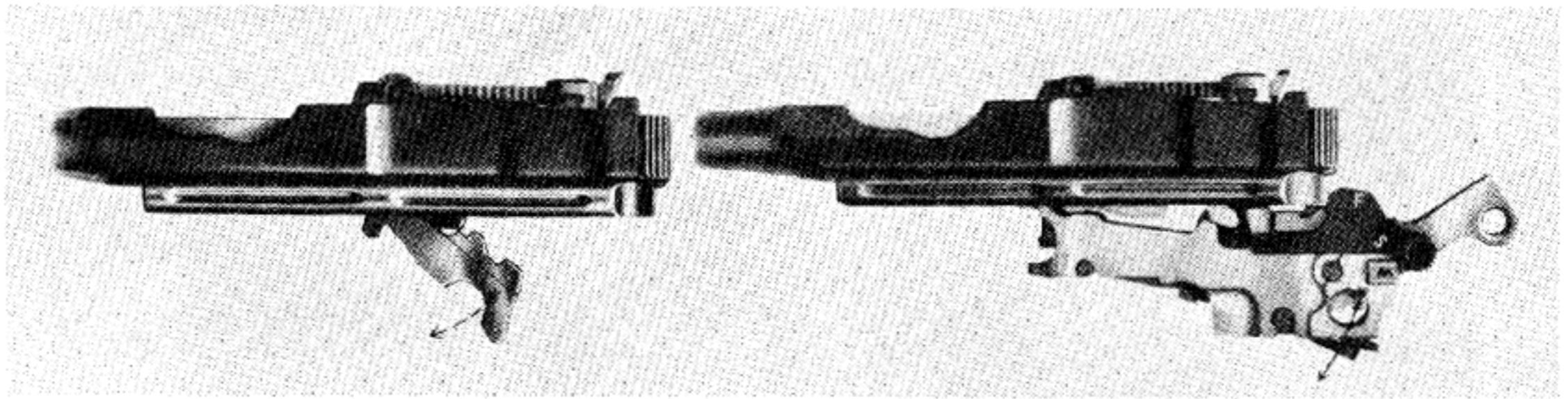

5. Lift out link member.

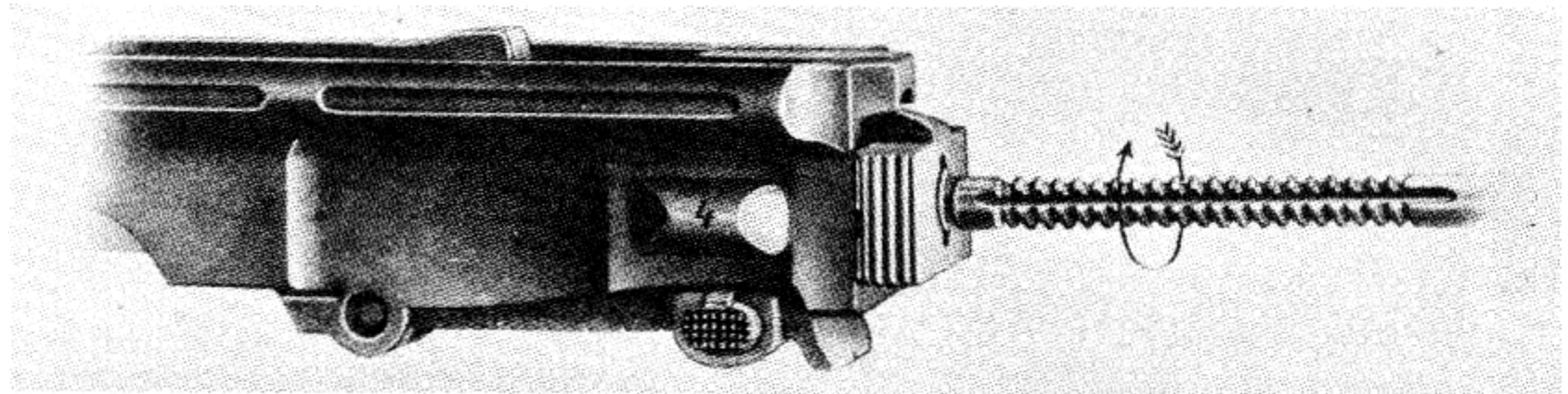

6. **Bolt removal:** (a) Press in on firing pin with a small screw driver, give a quarter turn from left to right and withdraw firing pin. (b) Now push forward bolt catch on right of barrel extension and withdraw it to the right. Bolt return spring is now released and bolt may be drawn straight to the rear.

## NOTE ON REASSEMBLY

1. Insert bolt into barrel extension. Then with small screw driver compress bolt return spring far enough to permit insertion of bolt catch from right side. This holds bolt in place.

2. Insert firing pin in its hole in the bolt, push bolt and give a quarter turn from right to left. This will lock it in.

3. With barrel assembly held **upside down** place the link over its pillar, insert the hammer mechanism over

the link and press home until ejector (which projects at the front end of the mechanism) positions into its slot on the under side of the bolt (during this operation be sure the hammer is cocked). Push down on the hammer mechanism and draw the receiver over it from the front until the catch engages in the receiver.

4. Replace magazine follower and its spring, compress and slide home the magazine base plate until it locks.

## HOW THE MAUSER AUTOMATIC PISTOL 7.63MM WORKS

Drawing the bolt straight back to the rear, compresses the recoil spring within it and rolls over the hammer to cock it. It is held cocked by the sear. When action is fully open, cartridges are stripped down into the magazine on top of the follower, compressing the magazine spring. The top cartridge is in line with the boltway. As the clip is withdrawn, the bolt is released and the recoil spring drives it forward. When the bolt nears the closed position a projection on the lock frame causes the link to swing forward and upward and engage its teeth in the locking recesses on the lower side of the bolt. This locks the bolt to the barrel extension. The locked bolt,

barrel and barrel extension are now moved forward to completely closed position. The trigger being pressed, the hammer falls, strikes the firing pin and discharges the cartridge in the firing chamber. The backward pressure of the recoil forces the locked bolt, barrel and barrel extension back about  $3/16''$ . At this point the barrel is stopped from further rearward travel, and pressure of the mainspring on the coupling pulls the link down freeing the sleeve from the bolt. At this point the sleeve (or barrel extension) and the bolt continue rearward; the extractor drawing the empty cartridge case out of the chamber and striking it against the ejector which hurls it out of the pistol.



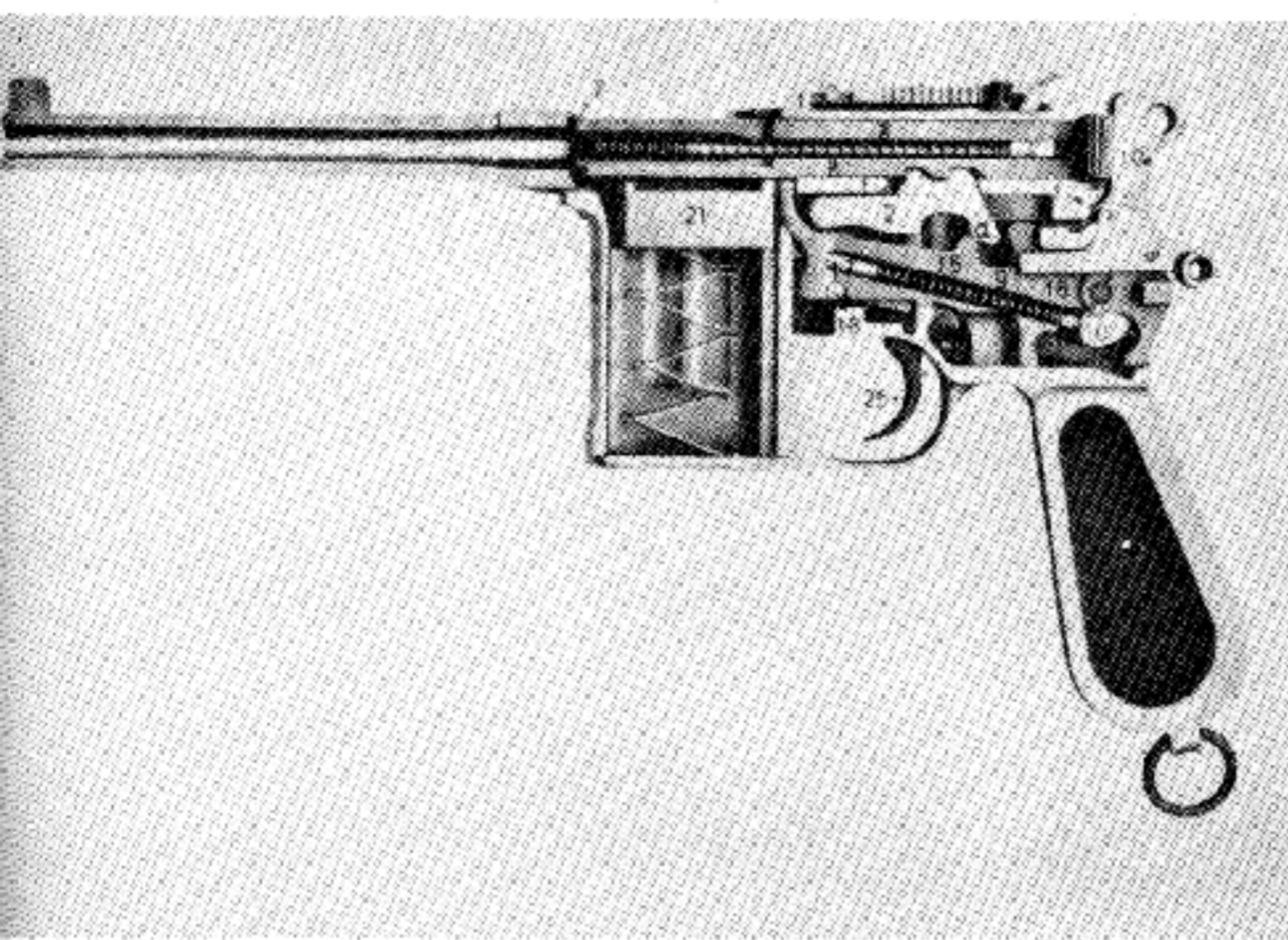

Pistol with Action in Full Forward Position.

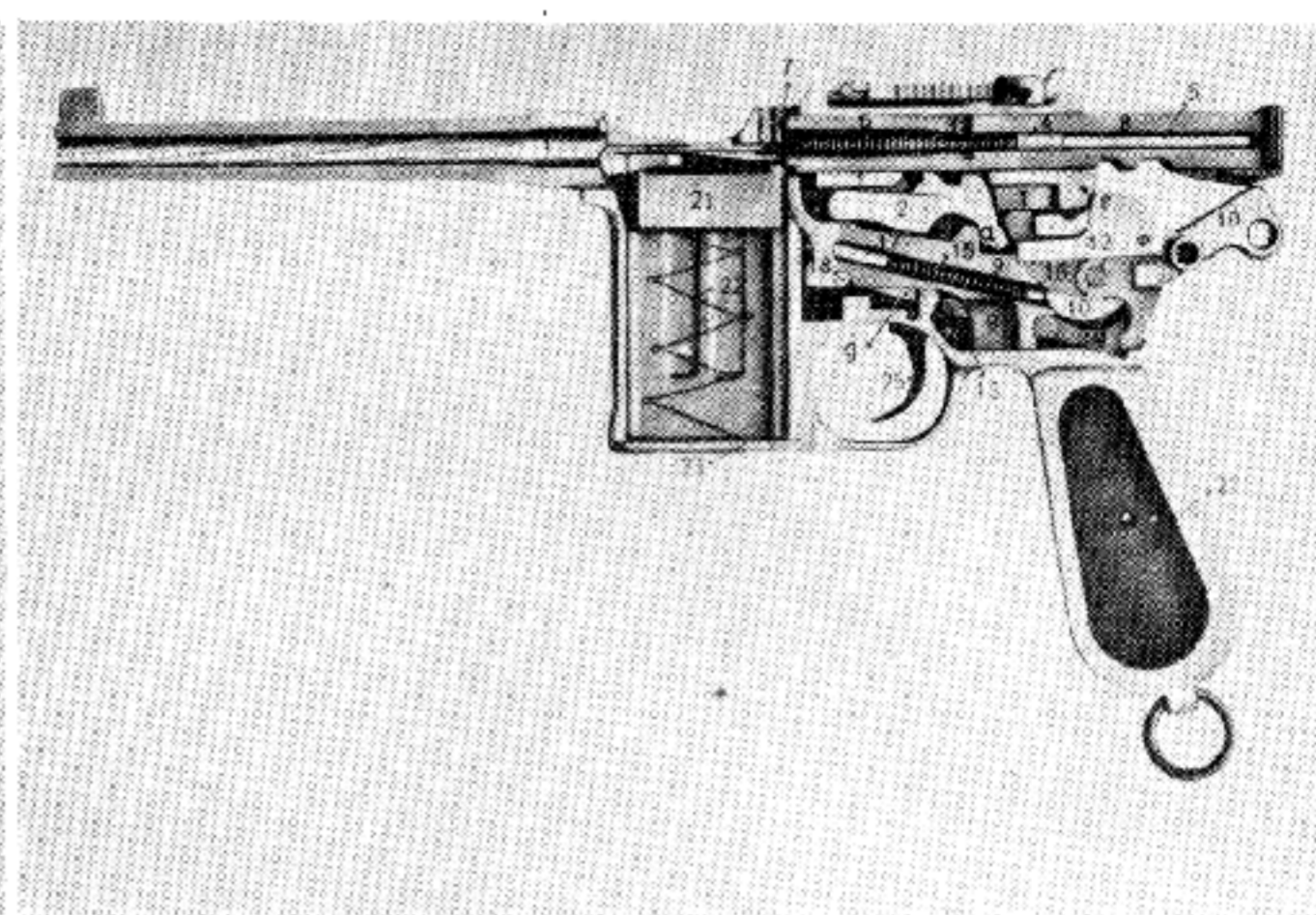

Pistol Open, Bolt Drawn Back, Ready for Loading.

1. (front) Barrel.
1. (rear) Barrel extension.
- 2-a. Bolt Lock.
3. Bolt Spring.
4. Bolt Spring Stop.
5. Striker.
6. Striker Spring.
7. Extractor.

8. Bolt.
9. Lock Frame.
10. Hammer.
12. (F-S) Safety.
13. Sear.
15. Mainspring.
16. Spring Bolt.
17. Rocker Plunger.

18. Coupling.
19. Lock Stop.
21. Magazine Follower.
22. Magazine Spring.
23. Magazine Bottom Plate.
25. Trigger.
27. Handle.

## USE OF THE MAUSER 7.63 MM AUTOMATIC PISTOL AS A CARBINE

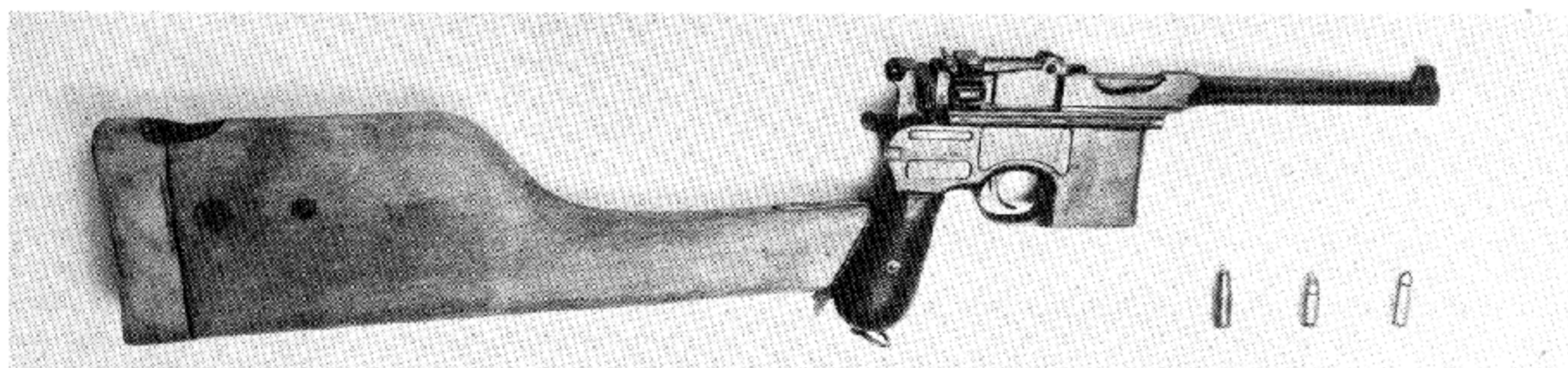

This pistol is usually issued in a wooden holster shaped so as to form a shoulder stock. The front end of this holster fastens rigidly to the lower end of the grip of the pistol. Because of the rifle-type design of the cartridge and its special ballistics, this weapon makes a

very efficient carbine. Its penetration is very great indeed. It is a particular favorite in Russia, Siberia, China and Malaya. It will be found in general use as a subsidiary weapon in nations all over the world. Used strictly as a pistol it is bulky and rather clumsy.

## MAUSER MILITARY PISTOL DESIGNED FOR 9MM PARABELLUM CARTRIDGE

Special models of this pistol manufactured during the First World War are encountered throughout Europe and Asia bored to take the 9mm Parabellum (Luger) car-

tridge. Such pistols will customarily have a large figure 9 carved into the stock which is usually painted red.

## CALIBER 9MM MAUSER

Although this caliber is no longer manufactured, cartridges are available and there are thousands of the pistols in use. Many were exported to South America, Turkey and the Balkans after the last war. This 9mm Mauser cartridge is a straight-cased cartridge whose overall length is .21" longer than the standard Luger

cartridge. It will **not** chamber in weapons designed to handle Luger-type cartridge. However, in certain 9mm Mauser models, the shorter Luger ammunition may function fairly well, although it is always susceptible to serious jams.



# GERMAN WALTHER 9-MM 38 AUTOMATIC

(Often Called Walther Military Model Auto.)



**Caliber:** 9mm.

**Parabellum:** (Pistol 08).

**Magazine:** Detachable box type in handle, capacity 8 cartridges.

**Ballistic Data:** Same as for Parabellum (Luger pistol).

**Barrel Length:** About 4 $\frac{3}{4}$ ".

**Overall Length of Pistol:** 8 $\frac{1}{2}$ ".

**Weight of Pistol:** 34 ozs.

**Sights:** Fixed. Inverted V front, open V-notch rear.

**Accurate Range:** 75-yards (German manuals give 125 yards, but very few men equipped with a pistol can do accurate work at such a range. 25-yards is the maximum range for average use of a pistol).

**Pistol Operated By:** Recoil.

**Locked:** By a locking piece swinging up from below as in the Mauser military pistol.

**Barrel and Slide Assembly:** Firmly locked together during the first quarter-inch of recoil.

**Type of Fire:** Single shot only, this weapon is fitted with a positive disconnecter preventing more than one shot being fired with each press of the trigger.

**Position of Slide When Last Shot Is Fired:** Open.

**Magazine Release Catch:** At rear of the bottom of the butt. Must be pushed back to release magazine.

**Safeties:** 1. Thumb catch on left rear of slide. Pushed down it exposes the letter "S" making the pistol safe. When this lever is thumbed up, the letter "F" is exposed and the pistol is ready to fire.

2. When firing chamber is loaded, a small pin will be seen to protrude from the rear end of the slide. If this pin is flush with the slide, the firing chamber is empty.

**Special Features:** This weapon is of very unusual design. It is fitted with a double-action movement. In the ordinary automatic pistol, the hammer must always be kept at full cock if the pistol is to be ready to fire on a moment's notice. In the Walther Pistol, once the slide has been drawn back and allowed to go forward over a loaded magazine to load the firing chamber, the hammer may be safely lowered and the pistol carried in that position. Then when you are ready to fire, you may either thumb-cock the hammer, as in the case of the Colt .45 Automatic under similar conditions, or you may simply **draw straight back on the trigger** as in the case of a double-action revolver, and the hammer will come to full cock and fall striking the firing pin. From that movement on, however, the weapon is full automatic pistol model again, and the hammer is cocked by the slide riding back over it.

When the pistol is at full cock after pulling the slide back, set the thumb safety in "safe" position; you may now drop the hammer without the danger of its striking the firing pin, a danger ever present when you are lowering the hammer on all other types of automatic pistols. Turning this safety locks the firing pin in its rear position.

## LOADING AND FIRING

1. Load and insert magazine in handle as is customary in all automatic pistols of this general design.

2. Draw back the slide, which will ride over the head of the hammer and cock it, meanwhile compressing the recoil springs and permitting a cartridge in the magazine to rise in line with the breechblock. Release the slide and let it go forward under the influence of the recoil springs.

3. If the safety catch has been in the "Fire" position during the backward movement of the slide, then the hammer will remain at full cock and the pistol is now ready for immediate firing.

4. If the safety catch was in the "Safe" position when

the slide was retracted, then the chamber will load but the hammer will go forward safely to its resting place. The pistol cannot be fired now as the safety is locking the firing pin. However, if you now remove the safety catch, the hammer may be cocked by the thumb, or the pistol may be fired by pulling straight back on the trigger bringing the double-action factor into play.

5. If the pistol is loaded, cocked and in firing position, pressing the catch down into the "Safe" will automatically and safely lower the hammer. Note: Remember if the safety catch is on "Safe" pulling back the slide will load the weapon but will not permit the hammer to remain at full cock.



# GERMAN WALTHER 9-MM 38 AUTOMATIC

## FIELD STRIPPING



1. Set the safety catch in the "Safe" position and pull the slide back over the empty magazine, so that the inside catch on the slide stop will be forced up by the magazine follower and hold the slide open. Then remove the magazine.



2. At the front end of the frame below the receiver is a lever-type locking pin. Turn this down and around as far as it will go.



3. Hold the slide under control with the left hand and with the right thumb push down the slide stop. Now press the trigger and pull the barrel and slide directly forward in their runners on the receiver, sliding them out of the guides.

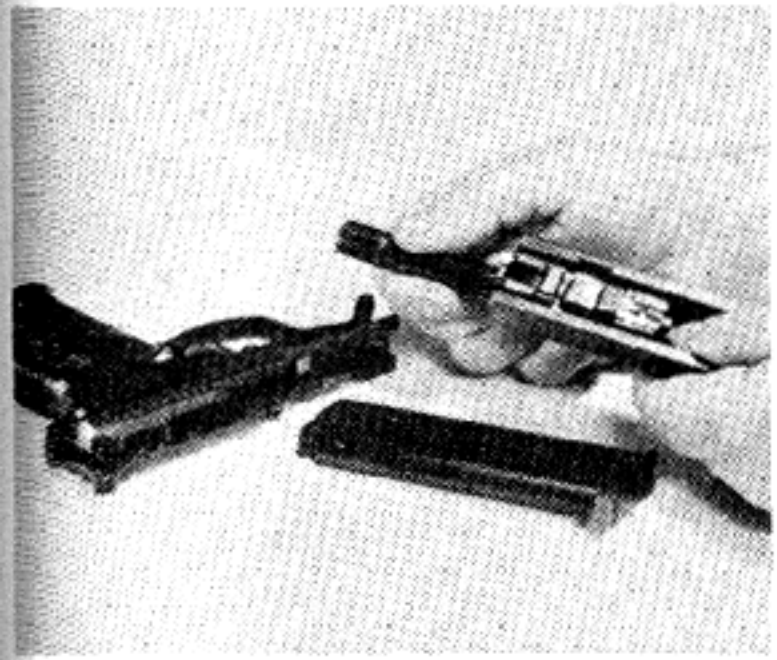

4. Now turn barrel and slide upside down. A small locking plunger will be seen at the rear of the barrel assembly. Push the plunger and spring out the white metal locking cam block.

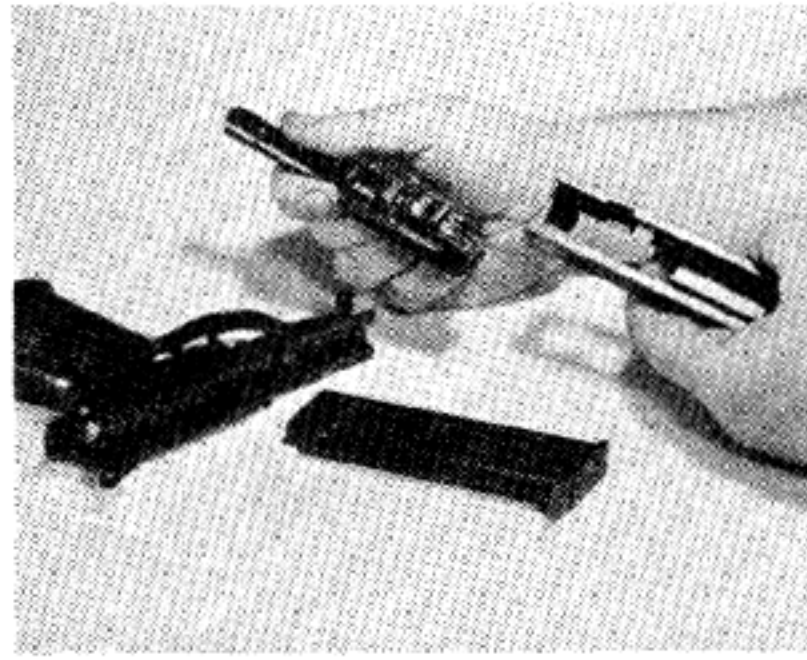

5. Now slide barrel directly ahead out of slide. Lock will come forward with barrel.

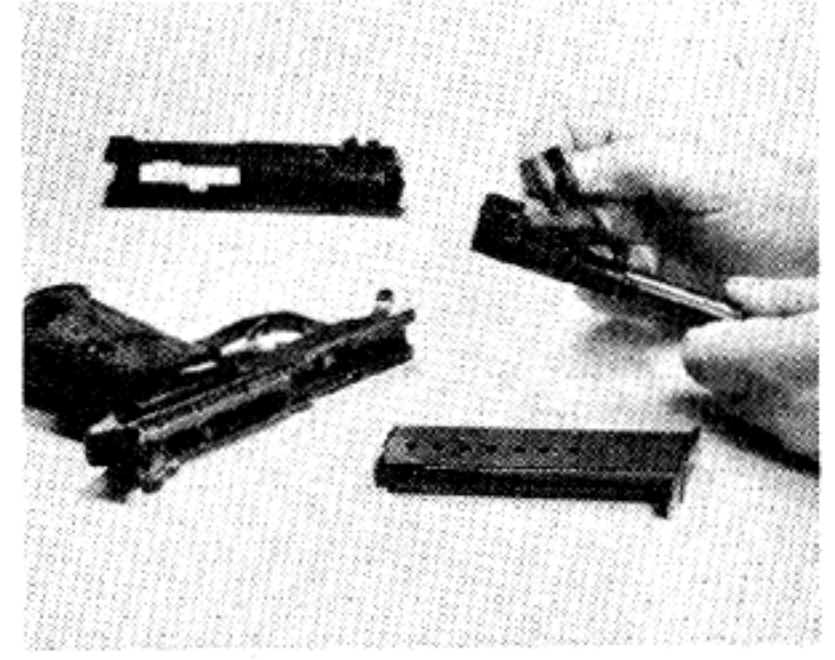

6. Push forward and up on locking cam block and lift it out of its recess. This completes field stripping.

### NOTE ON ASSEMBLY



Top to bottom, left: Slide, barrel, lock, magazine.  
Top to bottom, right: Receiver, stock.

1. Reverse stripping procedure.
2. When replacing locking block, be sure that its lugs are in line with the wide ribs on both sides of the barrel.
3. Insert barrel assembly as far as it will go into slide, then push the locking block into its locked position.
4. Hammer must be uncocked, and the ejector and the safety mechanism levers pushed down to prevent them from catching on the rear end of the slide.
5. With safety catch at "Safe" position, hold the locking block in the locked barrel position, and push the slide and barrel onto the receiver in the guide. Force the slide all the way back against the tension of the springs and raise the stop to catch and retain the slide in the open position.
6. Turn the locking lever around on its pin as far as it will go to its original position. Press the slide stop and permit the slide to run home. Insert magazine.



# GERMAN WALTHER 9-MM 38 AUTOMATIC

## SPECIAL NOTE ON THE PISTOL 38

This pistol appears likely to replace in time the Pistol '08 (Luger). It has all the good points of the old Luger and does away with practically all the bad ones. The grip, balance and hang of the pistol are as fine as in the Luger. This weapon is not muzzle heavy as are most automatic pistols. It also incorporates a fine, positive locking system on the general type of the Mauser automatic pistol with the locking block swinging up from below. Its general design, with the short slide running back on guides in the receiver, gives it the sturdiness of our own Colt automatic pistols. The position of the locking catch for the magazine is not good, and magazines cannot be extracted and inserted as rapidly as in the Colt and Luger.

It is the only Military Pistol fitted with the double

action hammer. In all other weapons of the type (Colt, Beretta, Steyr, etc.) when the firing chamber is loaded, the hammer is at full cock; and if it is eased down on the firing pin, must be drawn back by the thumb before the first shot can be fired. In the Walther, simply pulling the trigger will raise the hammer and drop it on the firing pin.

In the event of a light hammer blow, or a defective primer in the ordinary automatic pistol, it is necessary to draw the slide back by hand to eject the round from the firing chamber, or to recock the pistol by hand. A second or third pull on the trigger will very often fire a cartridge. In the Walther it is possible to do this without shifting position of hand or taking attention away from the target.



When the pistol is loaded with a cartridge in the firing chamber, a floating pin protrudes from the slide above the hammer. A glance or (in the dark) a touch will always tell whether the chamber is loaded, making it unnecessary to pull back the slide as in other pistols.



# GERMAN 9-MM 40 MACHINE PISTOL

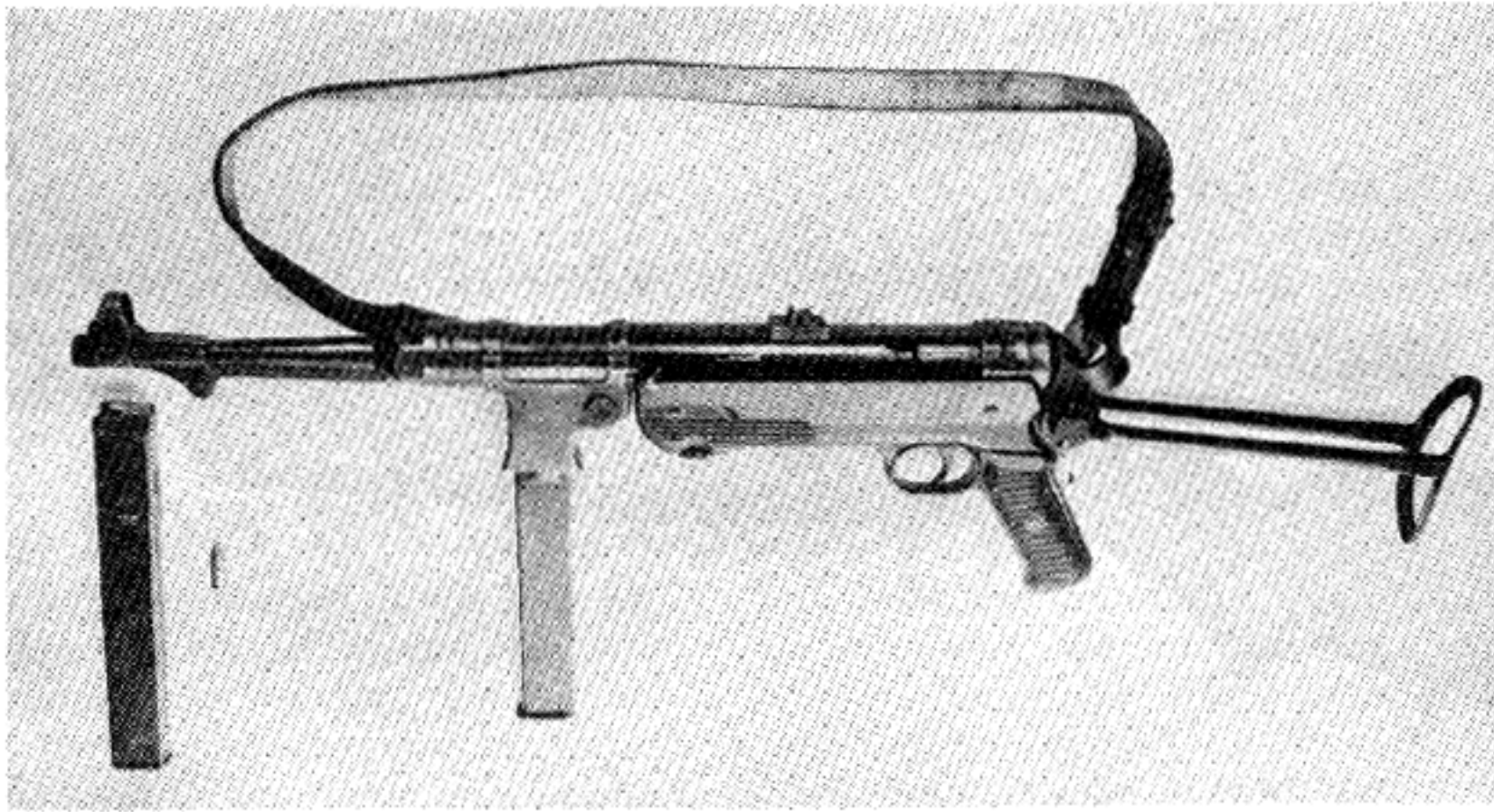

This is essentially the same weapon as the Model 38. Most of the changes made in it are to facilitate ease of manufacture. The receiver casing has been made smooth instead of corrugated as in the case of the M. P. 38.

On certain models a special locking device is incorporated on the cocking handle. Instead of the hook-shaped cocking handle, these models are fitted with a knob type. The knob must be **pulled out** slightly against the spring tension before the cocking handle can be drawn back to the rear, or released from the safety slot. This design is intended to overcome the danger

of a cartridge being fired when the cocking handle is accidentally freed from its locking recess, as by catching against clothing.

The correct position of the **left hand** when firing this weapon is gripping the corrugated section of the frame **directly to the rear of the magazine housing**. Holding the magazine itself, may cause serious jams. There is inevitably a certain amount of play in any magazine when it is locked into place; and if it is being used as a rest for the left hand during the course of recoil, it may rock the magazine mouth sufficiently to cause poor feeding.

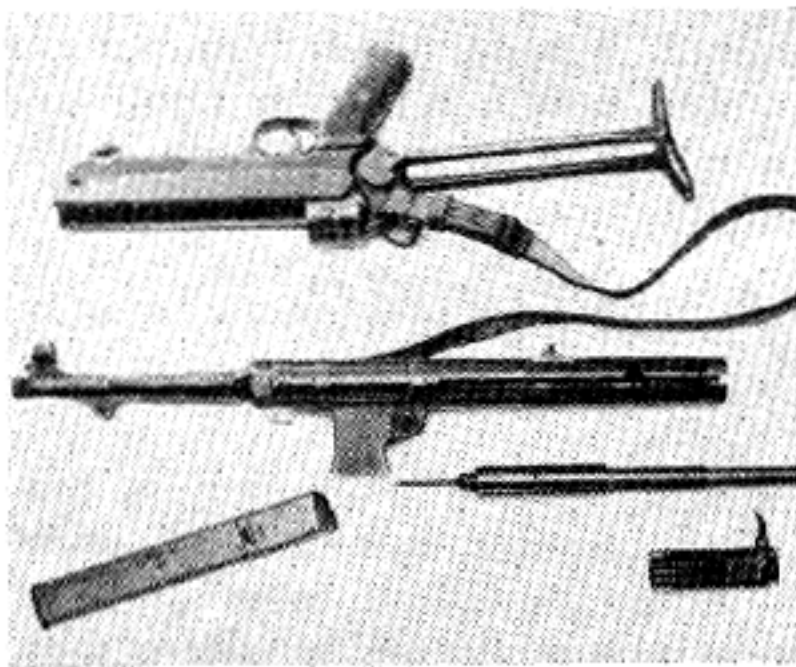

1. Weapon dismounted, complete field strip.

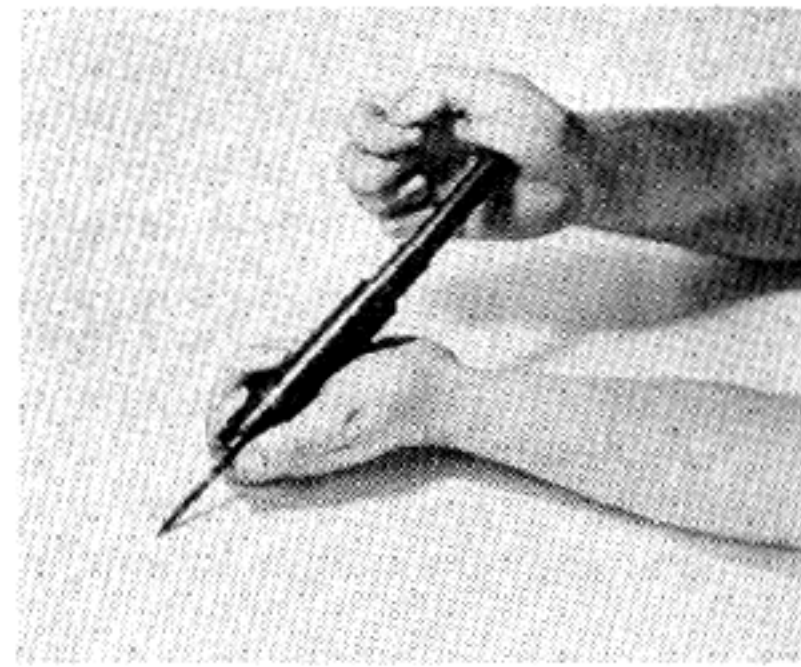

2. Recoil spring housing, showing firing pin and telescoping of tube.



# GERMAN STEYR-SOLOTHURN 9-MM MACHINE PISTOL

**Note:** In the United States, this weapon would be called a submachine gun. In Great Britain it is called a machine carbine.



**Caliber:** 9mm Parabellum.

**Magazine:** Detachable box type, capacity 30 rounds.

**Muzzle Velocity of Cartridge:** 1100 to 1600 feet per second in this barrel length.

**Weight of Bullet:** 125 grains, full jacketed with alloy or steel.

**Muzzle Energy:** 400 to 480 pounds.

**Magazine Positioned:** On left side of receiver slanting somewhat from the front.

**Length Overall:** 32 $\frac{1}{4}$ ".

**Weight:** 9 $\frac{7}{8}$  pounds.

**Sights:** Rear sight adjustable to 500 meters.

**Accurate Range:** About 300 yards.

**Gun-Operated By:** Recoil on the blowback principle.

**Locked:** Strictly unlocked. Weight of weapon, strength of recoil spring and forward moving parts combine to keep breech closed until period of dangerous pressure

has passed and bullet has left barrel.

**Cooled:** By perforated jacket surrounding barrel permitting air circulation.

**Cyclic Rate of Fire:** 700 per minute.

**Position of Cocking Handle:** A knob on the right side of the receiver.

**Bolt Position When Ready to Fire:** Open.

**Type of Fire:** Either single shot or full automatic. (a) Selector device is positioned in slot on left side of stock. (b) Push it forward to uncover the letter "E" for single shot fire. (c) Pull it back to uncover the letter "D" for full automatic fire.

**Safety:** Catch is on top of receiver directly ahead of the rear sight. Pushed forward against the stud it is "Safe." Pulled back against the sight, it is ready to "Fire." Safety may be applied both in the fired and the cocked position.

## INSTRUCTIONS FOR LOADING AND FIRING

1. Load magazine exactly as for automatic pistols if using loose cartridges.

2. **Pull back** the cocking handle and when the bolt stops at full cock, push the handle forward to its closed position.

3. (a) To fire a shot each time the trigger is pulled,

push the selector button on the left side of the stock forward.

(b) To fire full automatic as long as the trigger is held back, **pull** selector button back uncovering the lever "D." Note: except in cases of emergency the selector should always be set for single shot fire.

## FIELD STRIPPING

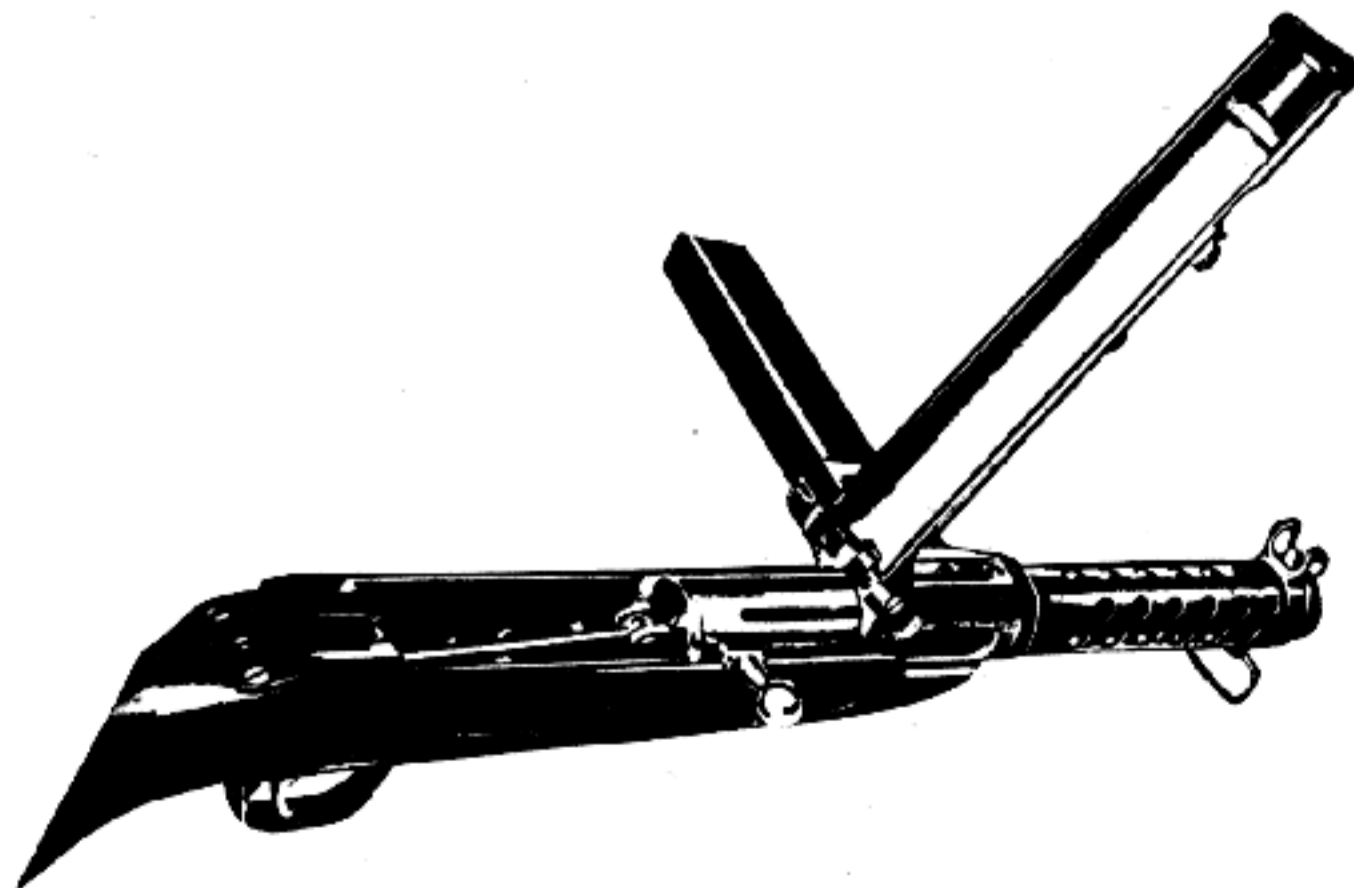



# GERMAN STEYR-SOLOTHURN 9-MM MACHINE PISTOL

1. On the cover directly behind the rear sight is a spring stud. While pressing this stud **down**, **push in** the catch at the end of the cover where it joins the stock. Now **raise** the cover. This cover is hinged directly above the firing chamber and to the side of the magazine housing. The entire bolt and breech mechanism are now open.

2. Draw the cocking handle back slowly, and when narrow portion of the bolt emerges **grasp that section**

**firmly** with the left hand. Hold the bolt securely while completing the back movement and **pull out the cocking handle**.

3. Now lift the **front end** of the bolt out of the guides, holding it firmly to prevent the mechanism from flying out under the pressure of the recoil spring and rod.

4. The recoil spring is removable through a small slot in the butt plate.

## HOW THE STEYR-SOLOTHURN WORKS

Magazine is loaded with 30 cartridges (it will hold 32, but best feeding results are achieved by loading with the lesser number). A ridge on the top side of the magazine strikes against the housing when the magazine is in the proper distance and the magazine locking catch on the rear of the housing snaps into place securing the magazine.

Pulling back on the cocking handle draws back the bolt, to the rear end of which is attached a hinged rod which pushes back against a housing, compressing a powerful recoil spring in the butt.

When the bolt is all the way back, the sear engages. The cocking handle is now forced forward again so it

will not be necessary for the bolt to carry it in its loading and firing motion.

The trigger being pressed, the bolt is released to be driven forward by the compressed recoil spring. The feed slots on its underside strip the top cartridge from the magazine into the firing chamber.

The firing pin in the bolt explodes the cartridge as it is being seated and the extractor snaps into the cannelure of the cartridge case.

The heavy bolt and powerful recoil spring during the forward motion hold the bolt safely closed until the bullet has left the barrel.

## SPECIAL NOTE ON LOADING MAGAZINE

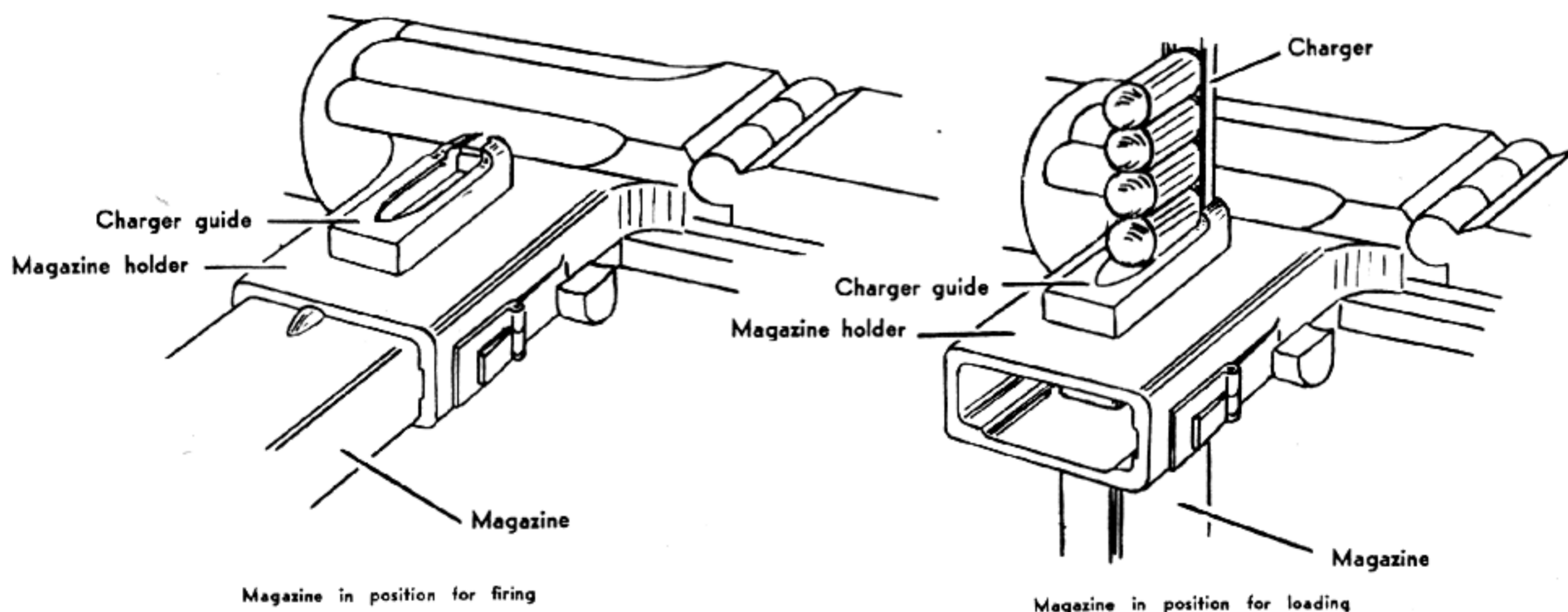

This weapon has a unique magazine loading device machined into it. To load with this device:

1. Insert magazine into bottom of magazine housing. A special slot is cut on the underside of the housing to permit this.

2. The special lock catch on underside of housing will lock it into place.

3. Now insert a standard 8-shot clip in the clip guide on top of the magazine housing.

4. Press the cartridges **straight down** into the magazine exactly as in rifle loading. When magazine is fully

loaded, press release catch and pull it out from the bottom of the housing. It is now ready for insertion in the **side** of the housing for loading the weapon to fire.

**Added Note:** The right side of the barrel casing is equipped to permit fixing a standard German Army bayonet.

The Steyr-Solothurn in use by the Japanese takes the 7.65mm Luger cartridge.

If this weapon is stamped "MP 34 (ö)" it indicates it was issued for **Austrian** use and takes the long 9mm Steyr cartridge—**not** the 9mm Parabellum.



# GERMAN MAUSER 7.63-MM 1932 MACHINE PISTOL

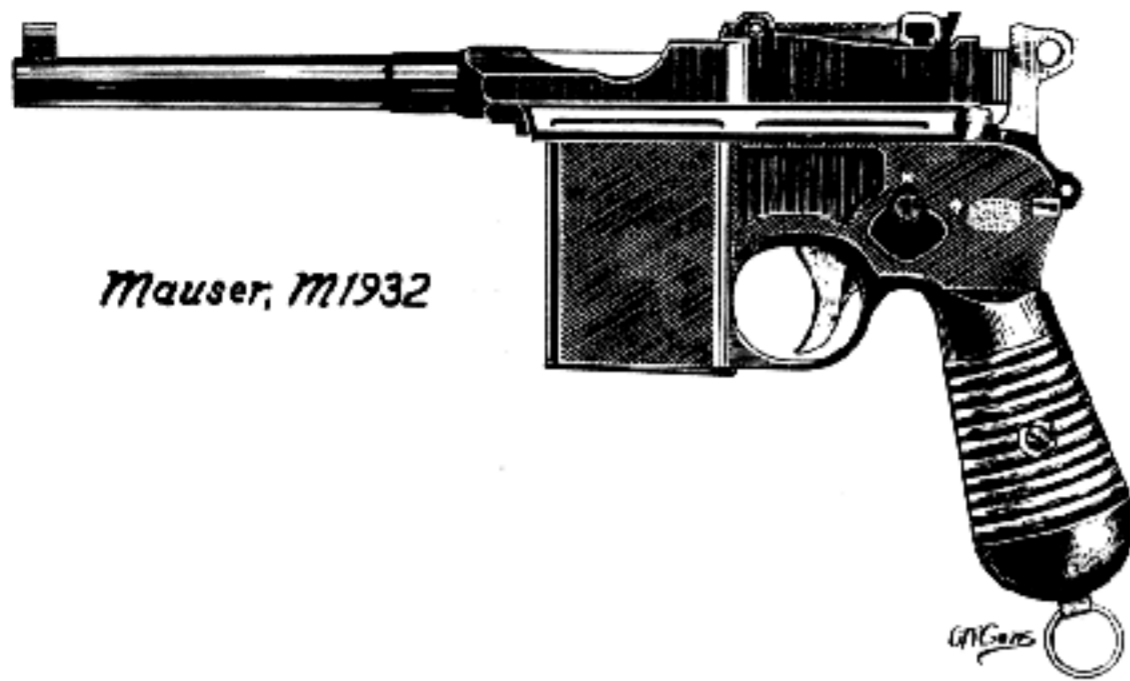

(Mauser Machine Pistol)

**Note:** This is a full machine pistol. It is a freak weapon intermediate between the pistol and the submachine gun.

**Caliber:** 7.63mm Mauser.

**Magazine:** Sheet metal detachable box.

**Capacity:** 10-shot or 20-shot depending on length of magazine. It is inserted into magazine housing from below until it locks. It may be loaded with clips from the top through the open action exactly as in the case of the standard Mauser Military Pistol.

**Type of Fire:** Single, shot or full automatic. Turning ring button on left side of pistol above and behind the trigger prevents the disconnecter from functioning and allows the pistol to fire as long as the trigger is held back and there are any cartridges left in magazine.

## HOW AUTOMATIC FIRING MECHANISM WORKS

The ring button lever on the left side of the pistol is turned to letter "N." There are two teeth on the axis of this lever, one engaging the catch hook bar and the other one working on the pawl. Turning the ring button pushes the catch hook bar forward allowing it to operate and pushing pawl forward. When this pawl is in forward position the sear is held out of engagement with the hammer as long as trigger is held back. When catch hook is in operating position, its middle arm engages

notch in the hammer and holds the hammer cocked. The tip of the upper arm of the catch hook works in a slot in the bottom part of the barrel extension sleeve. When the barrel extension strikes the catch hook it revolves it, releasing the hammer. Hence the hammer falls automatically as soon as the action is locked; and the pistol continues to fire so long as the trigger is held back. When the trigger is released the sear engages the hammer and stops the firing.

## NOTE ON USE OF THIS WEAPON AS A MACHINE PISTOL

This weapon should be used as a machine pistol only when the shoulder stock is attached so that stock may be pressed rigidly against shoulder or against side, with right hand firmly gripping handle and left hand holding rigidly to magazine housing.

Because of the high power of the cartridge and the low weight of the pistol and its recoiling members, the cyclic rate of this weapon is **entirely too high** to make it of any value for ordinary military use. It is in wide use among the S. S. Troops for the value its automatic firing device might have against mobs. Used as a pistol, this weapon functions so rapidly that it is almost impossible to distinguish between the reports of the different cartridges as they are exploded. Regardless of the strength of the firer, the succession of repeated recoils throw the weapon upward and backward so that it is utterly impossible to hold it down even if both hands are used.

While the first shot may hit the point of aim, the succeeding shots, except at ranges of a few feet, are bound to go high and miss. This merely wastes ammunition.

Using this weapon as a carbine, it is possible to fire in bursts of three or four shots. In this case, it has a practical military value.

**Note:** The Model 1932 Mauser is also manufactured in Spain where it is produced under the name of ASTRA Machine Pistol.

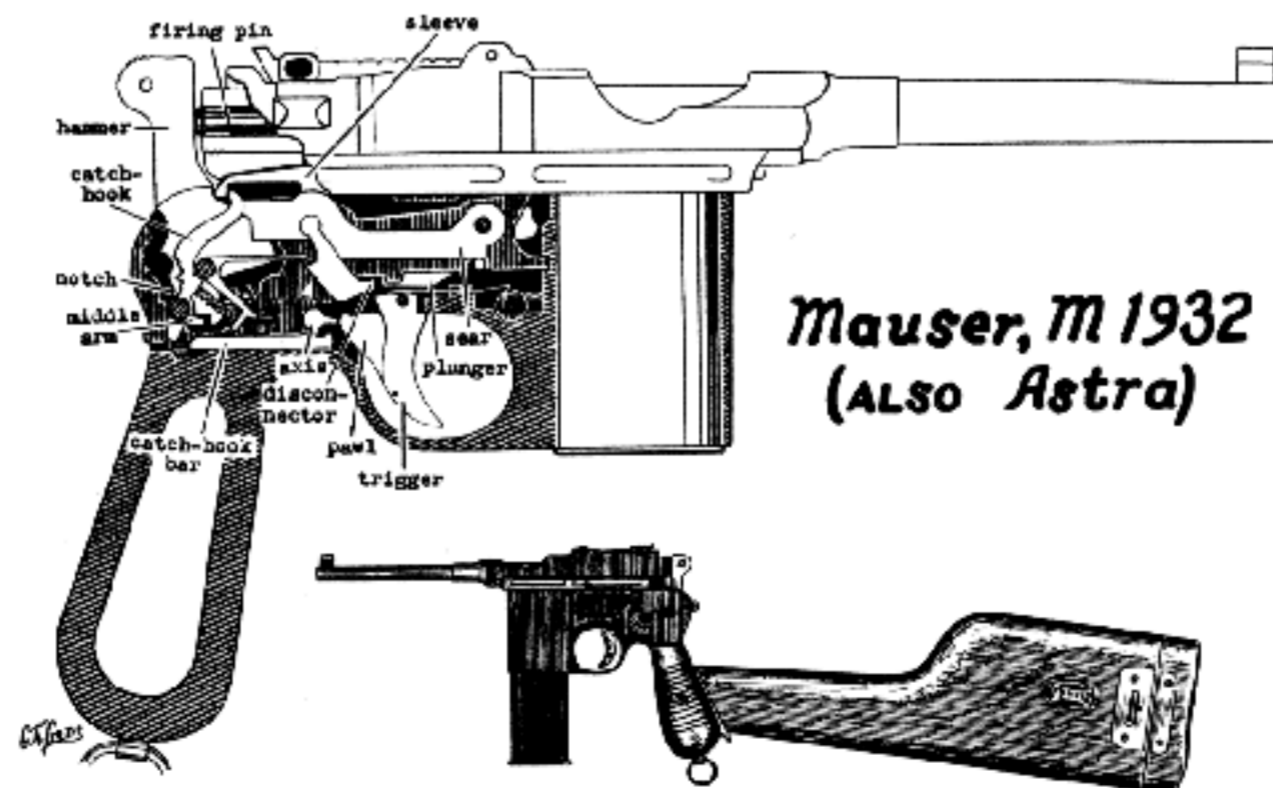



# GERMAN ERMA 9-MM MACHINE PISTOL

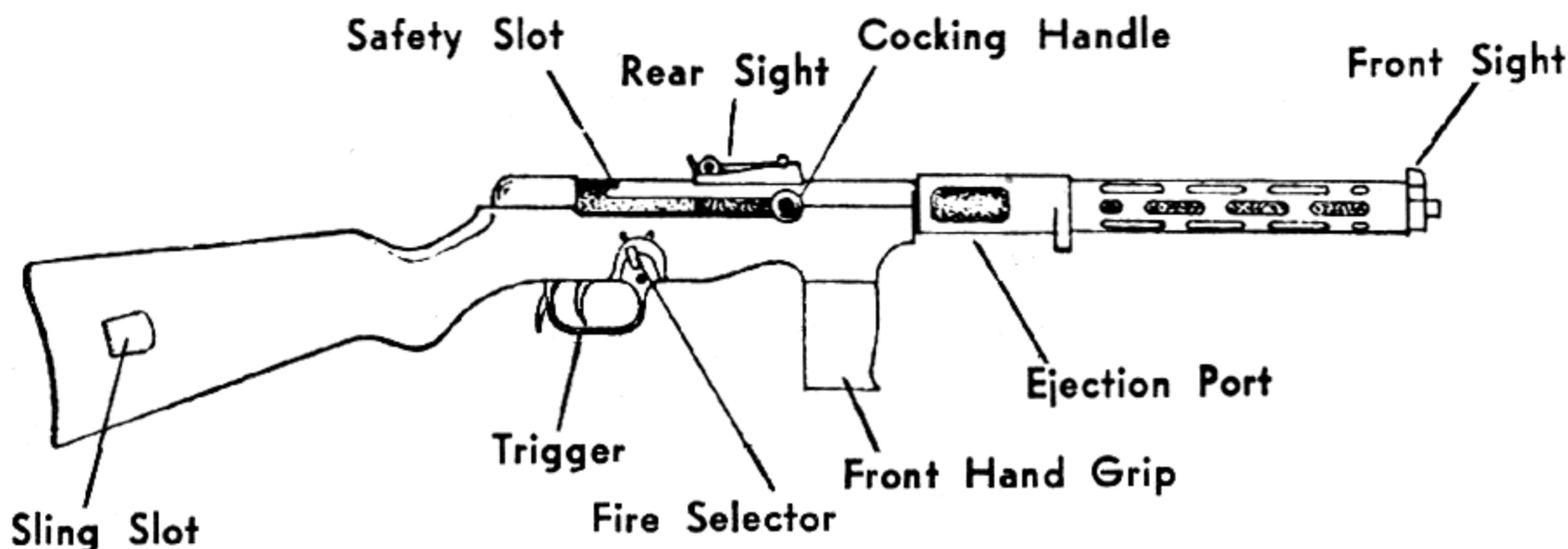

**Note:** This weapon is sometimes called the Schmeisser machine pistol or carbine.

**Caliber:** 9mm Parabellum (Pistol 08).

**Magazine:** Removable box type, single line. Positioned in housing on left side of weapon at an angle forward.

**Ballistic Data:** Same as for Steyr-Solothurn.

**Overall Length:** 33 $\frac{1}{4}$ ".

**Weight:** 9 lbs.

**Cyclic Rate of Fire:** 520 rounds per minute.

**Operation in Locking:** Similar to Solothurn.

**Cooling:** Similar to Solothurn.

(Barrel casing and radiation slots of different shape.)

**Type of Firing:** Single shot or full automatic. Selector device will be found on **right side** of weapon directly above front end of trigger guard.

**Safety:** The only safety on this weapon is a recess to the rear of the cocking handle slot. When the cocking handle is at full cock, it may be drawn still further back, then **turned up and pushed into locking slot**.

**Note:** A specially designed, pistol-type grip for the left hand extends downward from the front end of the stock.

This weapon is patterned after the Steyr-Solothurn, and in general operation follows its working principle.

## LOADING AND FIRING

1. Insert magazine in magazine housing on the side of the weapon and push home until the catch locks.

(The locking catch is placed on the top near side of the magazine housing.)

2. Pull cocking handle back as far as it will go, then

push it forward. Bolt itself will stay open; only exterior handle will move.

3. Pull cocking handle back and up into locking recess for safety. Now set thumb selector for "**single**" or "**full automatic**" fire as desired.

## FIELD STRIPPING AND REASSEMBLY

1. Push in on the catch in the rear of the receiver. This releases the casing which may be hinged **up to the front** exactly as in the case of the Steyr-Solothurn.

2. Now twist the recoil spring cap about 45° to the left. Withdraw the recoil spring and recoil spring cap.

3. Now raise the rear end of the lever which extends into the left side of the boltway and pull out the bolt and the firing pin.

Reassembling this weapon is not as simple as in the ordinary weapon of this type, hence the following description is necessary.

1. Start by inserting the bolt and the firing pin in the rear of the receiver.

2. Now push forward plunger at the rear of the trigger mechanism beneath the receiver to clear the sear from the boltway.

3. Turn the cocking handle **up** into its slot and thrust the bolt **forward**. The bents of the bolt and the sear will engage and hold it up; and it is **again** necessary to **push forward** the plunger before the bolt can be thrust home.

4. Attach cap to recoil spring and insert. Set the catch on the cap at an angle of 45° to the left and line up the cutaway sections above the cap and the receiver; turning the end cap to the vertical will now lock it into place. Now **snap down** the cover to lock it to the receiver.



# GERMAN 9-MM 38 MACHINE PISTOL

(Sometimes called Parachute Model, Schmeisser)

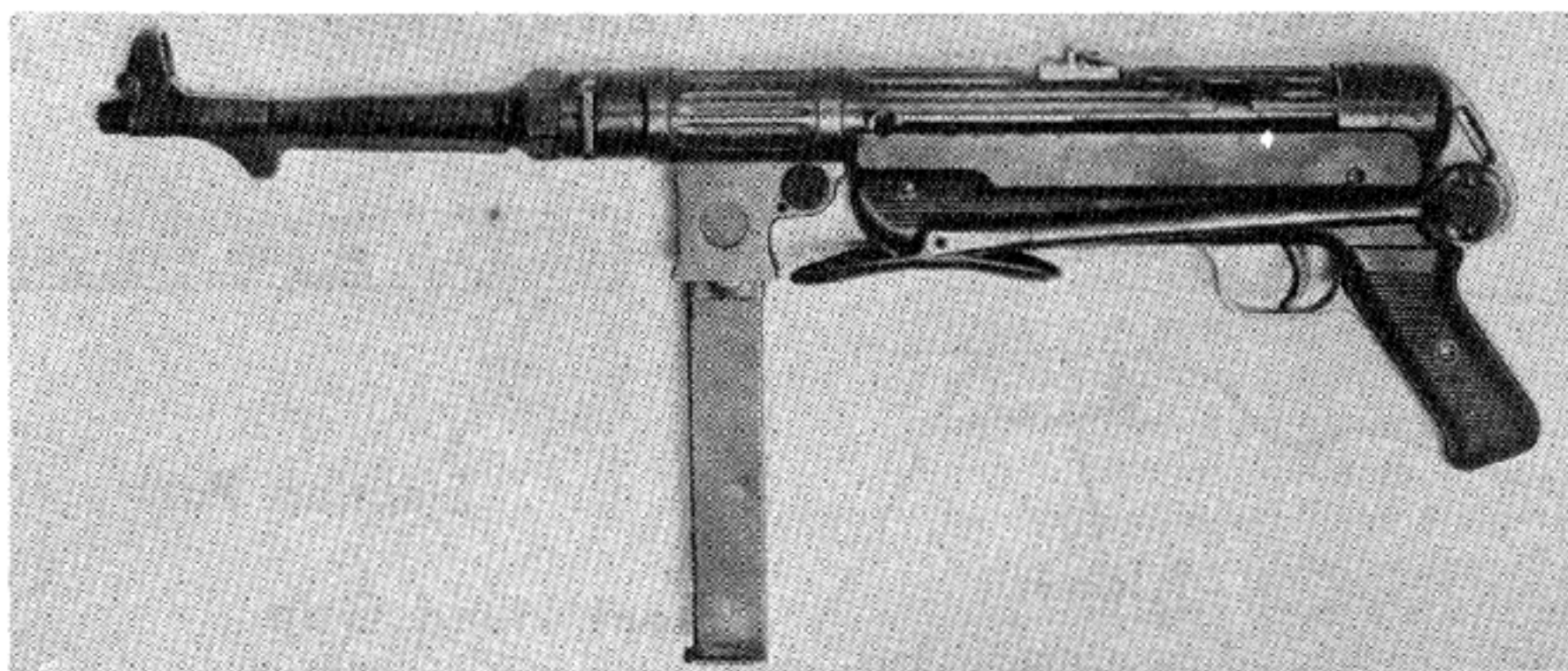

**Note:** This weapon was originally designed for use by Parachute Troops. It is so much superior to all other types of German submachine guns (or machine pistols, as the Germans call them); that this and its modification the MP-40 have rapidly supplanted all other types of machine pistols in use in the first line German Army. It is issued to Platoon and Section commanders, to the Armored Force Units for racking up in tanks, armored vehicles and lorries, and to parachute troops. The design is excellent.

**Caliber:** 9mm Parabellum, ball or semi-armor piercing ammunition.

**Magazine:** Single line box type, capacity 32 cartridges. (As in most machine pistols, best results are obtained by loading the magazine to **less** than full capacity. 26 or 28 cartridges are recommended for this weapon.)

**Weight:** 9 lbs. without magazine.

**Weight of Magazine:** Loaded, 23 ozs.

**Overall Length with Stock Folded:** About 25 inches.

**Overall Length with Stock Extended:** About 35 inches.

**Sights:** Fixed front with sight cover.

**Sights Rear:** Open. A standing leaf is sighted at 100 meters. Behind this is a folding leaf which when turned up provides a sight for 200 meters.

**Accurate Range:** About 200 meters.

**Gun Operated By:** Blowback pressure of gas forcing empty cartridge case back against bolt.

**Locked:** Straight blowback, unlocked. Breech is closed until bullet leaves barrel by inertia of moving parts and heavy recoil spring moving forward and pressing bolt against head of cartridge.

**Cooled:** Bolt remains open between shots, permitting air circulation through breech and barrel. Below barrel is a flat aluminum bar, designed primarily to protect barrel when being rested on cover. This bar may have some theoretical cooling effect in drawing

off barrel heat, but its value is highly questionable. **Cyclic Rate of Fire:** 450 to 540 rounds per minute, depending largely on type of ammunition used and strength of springs.

**Position of Cocking Handle:** On left side of receiver. It is hook shaped.

**Magazine Locking Catch:** On left side at rear end of magazine housing. It is a large, milled thumb piece. It is **pressed in** to release magazine.

**Stock Release Catch:** On receiver just above grip. **Pressing** the milled stud in the left side of the weapon releases the spring and permits the stock to be unfolded; the butt piece for the shoulder can then be opened.

**Type of Firing:** Full automatic **only**. Bursts of two or three shots are possible by tapping trigger.

**Safety:** The only safety provided in this weapon is a safety recess with the letter "S" stamped near it at the rear of the cocking handle slot. Pulling the cocking handle **past** the full cocked position and then **up** into this slot locks the weapon. This type of safety is subject to jarring or turning out of engagement without being noticed; it is a **practical** military device, but not a foolproof one.

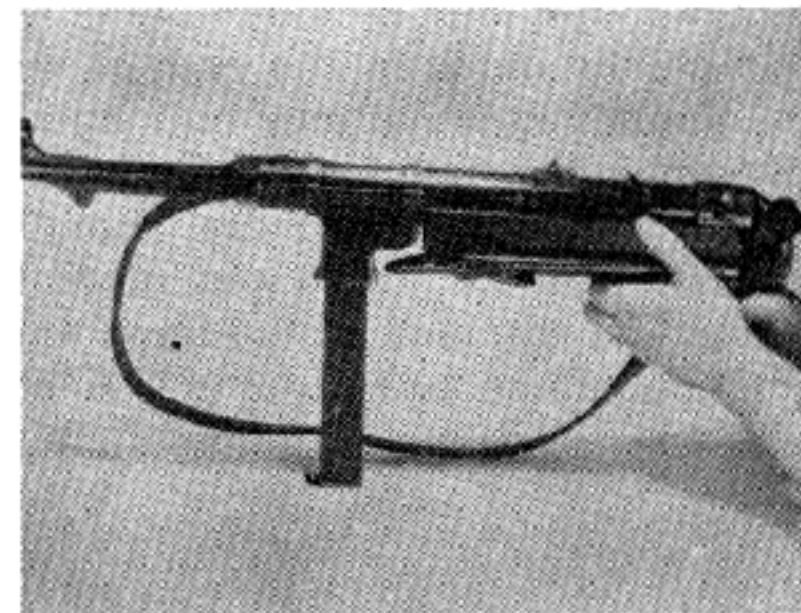

Safety Being Applied.

## LOADING AND FIRING

Six spare magazines and a special magazine loader are issued in a webb haversack with each one of these guns. The loader is a simple lever device with an attached housing into which the magazine is inserted. Snapping a cartridge into the top of the housing and pushing down firmly on the lever loads the individual cartridge into the magazine. This motion is repeated

until the magazine is filled. If no loader is available, cartridges may be inserted by the normal procedure for loading automatic pistol magazines; leverage for inserting the last few cartridges may be exerted by pressure of both thumbs, once the cartridge has been seated.



# GERMAN 9-MM 38 MACHINE PISTOL

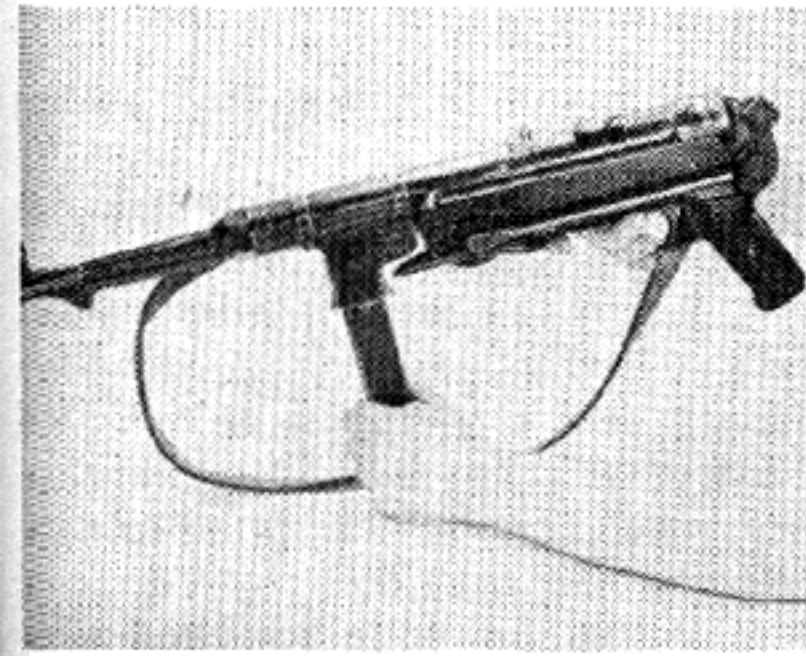

1. Insert loaded magazine from below into the magazine housing and push up until it locks. Note: A stud on the outside of the magazine will prevent it from going in beyond the proper length.

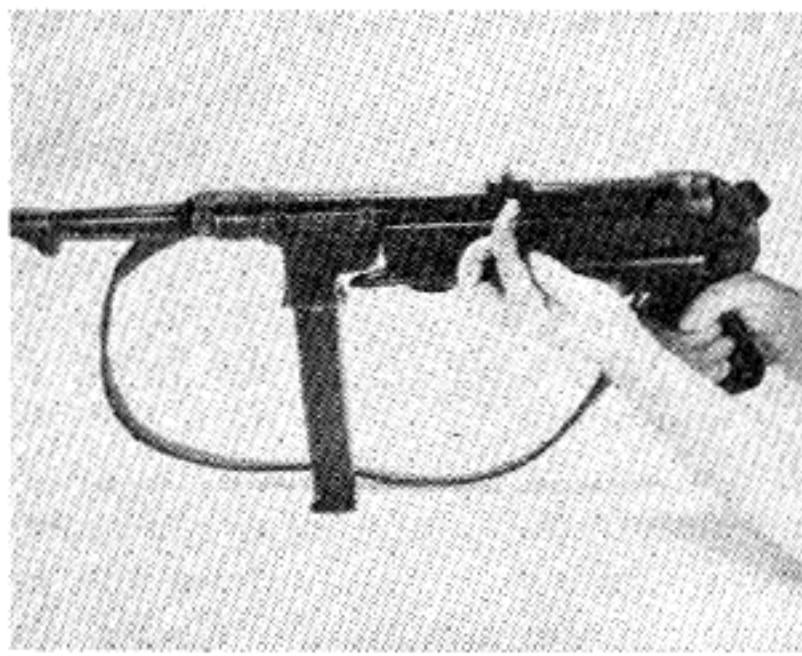

2. Pull back cocking handle and lock it up in its recess in the safety slot.

3. Warning: Always remember that this weapon fires **when the bolt goes forward!** Never, therefore, let the bolt go home while the loaded magazine is in position. Unless you wish to fire the weapon, **always extract** the magazine before easing the bolt home.



4. Whenever possible, always use this weapon as a carbine. To do this, press the catch stud as indicated. This will release catch and permit you to unfold the stock and turn the butt piece down into proper place for firing from the shoulder.

## FIELD STRIPPING

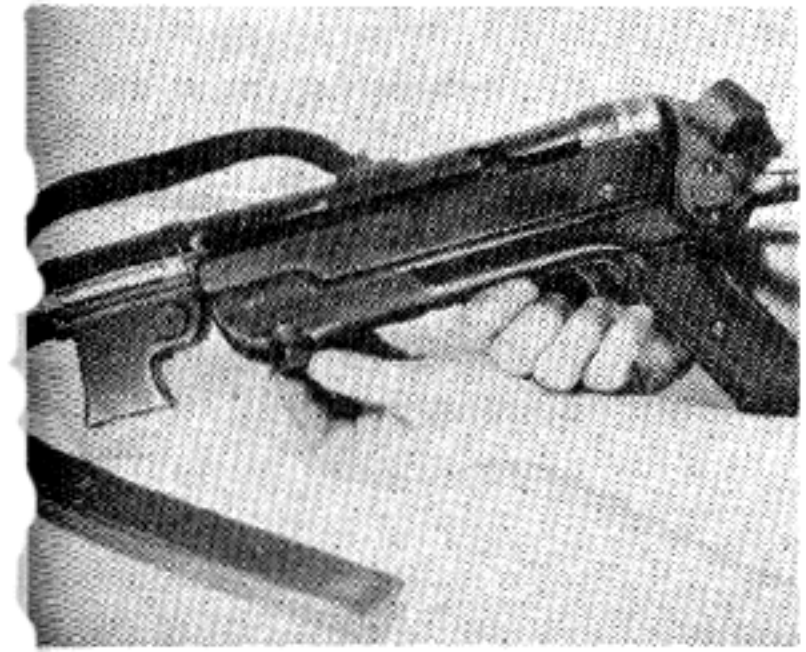

1. After extracting the magazine, and seeing that the bolt is in its forward position, pull out the receiver lock against the tension of the spring and twist it to keep it locked in the outward position. (This stud is on the bottom of the frame at its forward end.)

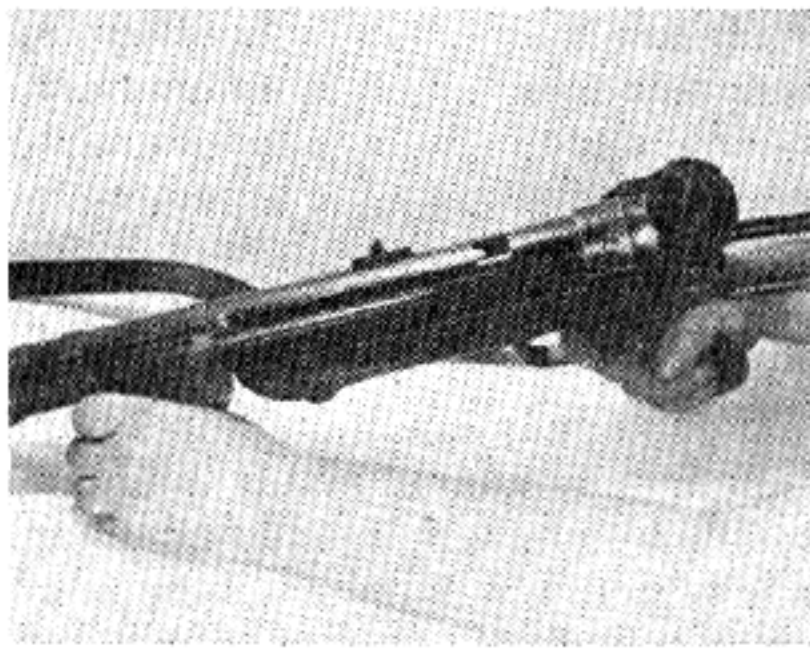

2. While pressing the trigger with the right fore finger, hold firmly to the magazine housing with the left hand, then twist the pistol grip **to the right, about 80°**; this will revolve the entire frame assembly and the components.

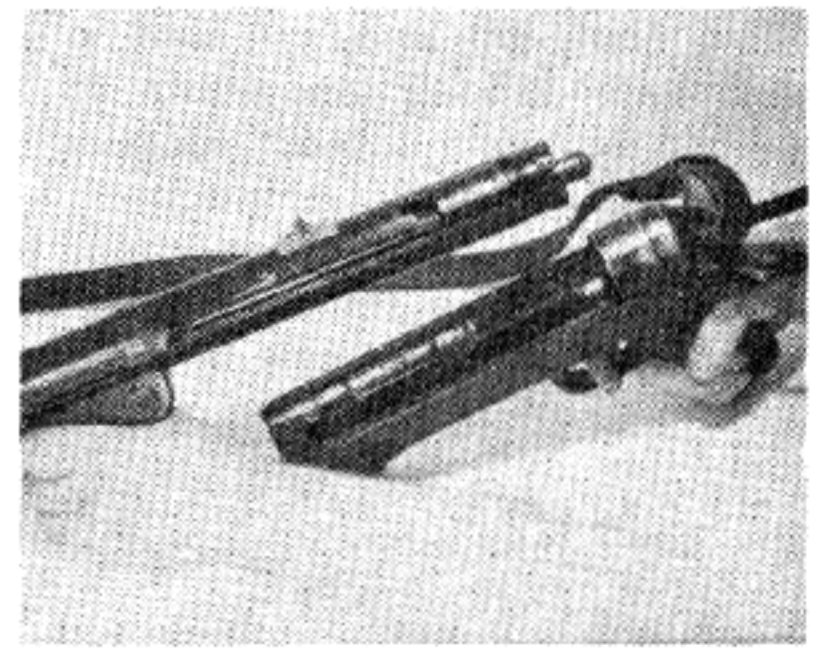

3. Now draw the frame group **back and out of the receiver.**

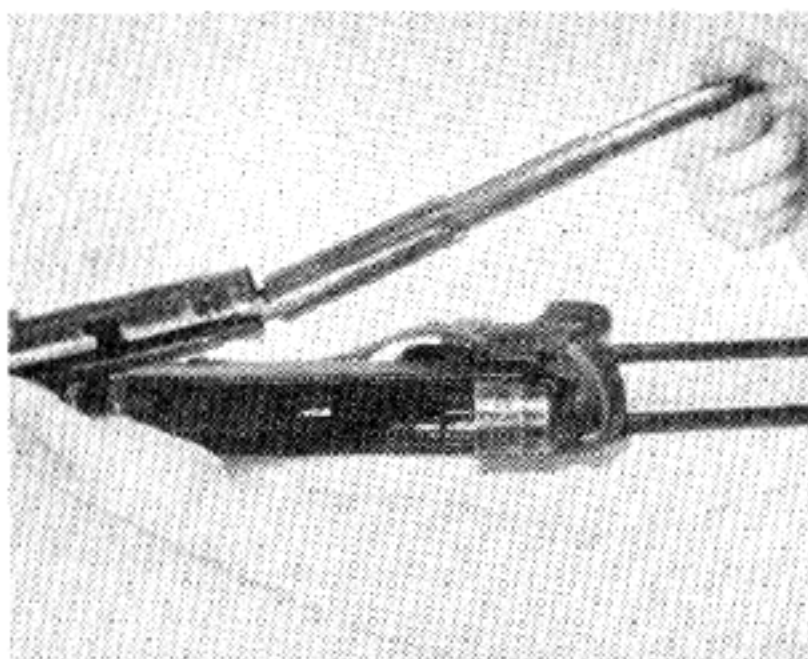

4. Draw back slightly on cocking handle. This will bring out a telescoping tube inside which is the recoil spring, and at the front of which is the firing pin. Remove this unit.

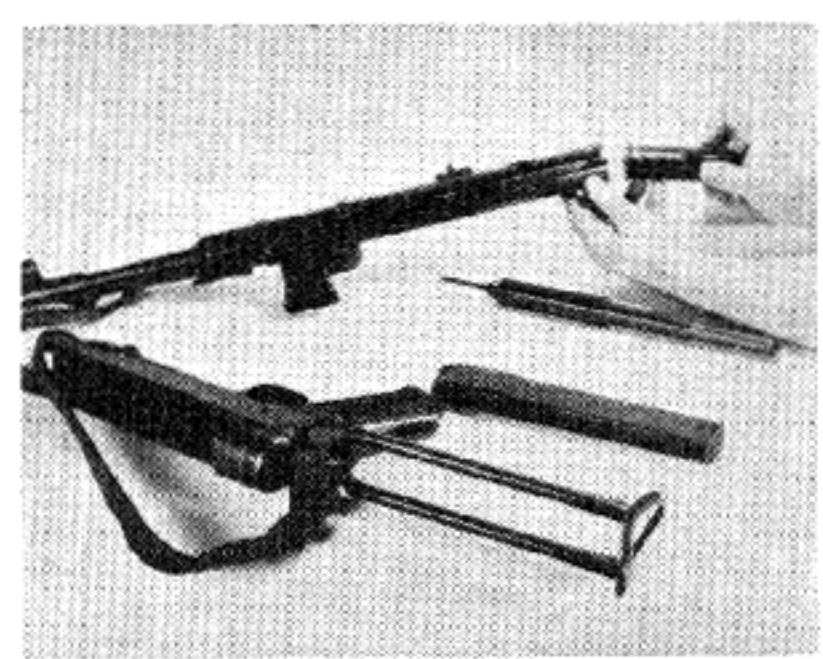

5. Now draw straight back on the cocking handle which is a part of the bolt and withdraw the bolt from the receiver. No further stripping is required.



# GERMAN 9-MM 38 MACHINE PISTOL

## HOW THE M.P. 38 WORKS

The loaded magazine inserted from below is held securely in place by the magazine lock. The firing pin is attached to the forward end of the telescope housing. It passes through the hole in the center of the bolt, while the abutment behind it lodges into the head of the bolt recess. As the bolt is drawn back by its handle, or forced back by the force of an explosion, it telescopes the three piece recoil spring housing (which carries the firing pin) and compresses the recoil spring which is inside the telescope. The rear of the recoil spring housing rests against the inside of the rounded buffer end of the frame, which is securely locked to the receiver.

When the bolt is in the fully cocked position, the sear locks into the bottom of the bolt and connects with the trigger. Pressing the trigger depresses the sear and permits the bolt to run forward under the influence of

the recoil spring acting through the telescopic section to force the bolt forward.

As the feed ribs on the bottom of the bolt strip the top round from the magazine and push it into the firing chamber, the face of the extractor set in the bolt **blocks the firing pin** to prevent it from striking the cartridge until the round has been securely chambered. As the cartridge is seated, extractor snaps over the cannelure in the cartridge case, and permits the firing pin to strike the primer exploding the cartridge.

During the backward action the extractor hook withdraws the empty cartridge case, carrying it back until it strikes against the ejector and is hurled out of the breech. This cycle of operation continues as long as the trigger is held back and there are any cartridges left in the magazine.

## NOTE ON THIS WEAPON

This machine pistol was developed by the Schmeisser factory at Suhl, Germany. It uses steel and plastics throughout—no wood is used in its construction. Experimental models are known to have been made in caliber 11.43mm (almost identical with our .45 Automatic Government Cartridge). Apparently they have never been put into production, because all captured types are of the standard 9mm caliber. This weapon (in common with our new M-3 Submachine Gun and our Reising Gun) is equipped with a folding stock which

makes it possible to use the weapon as a machine pistol, using one or both hands, or as a machine carbine shooting from the shoulder. All other types of this weapon either have a solid stock which cannot be removed; or have a removable stock which must be carried separately when detached. A study of Russian news-reels discloses a very wide use of this weapon by Russians, both soldiers and partisans. The Russians have shown amazing adaptability in converting to their use superior types of captured equipment.



# GERMAN NEUHAUSEN 9-MM MACHINE PISTOL

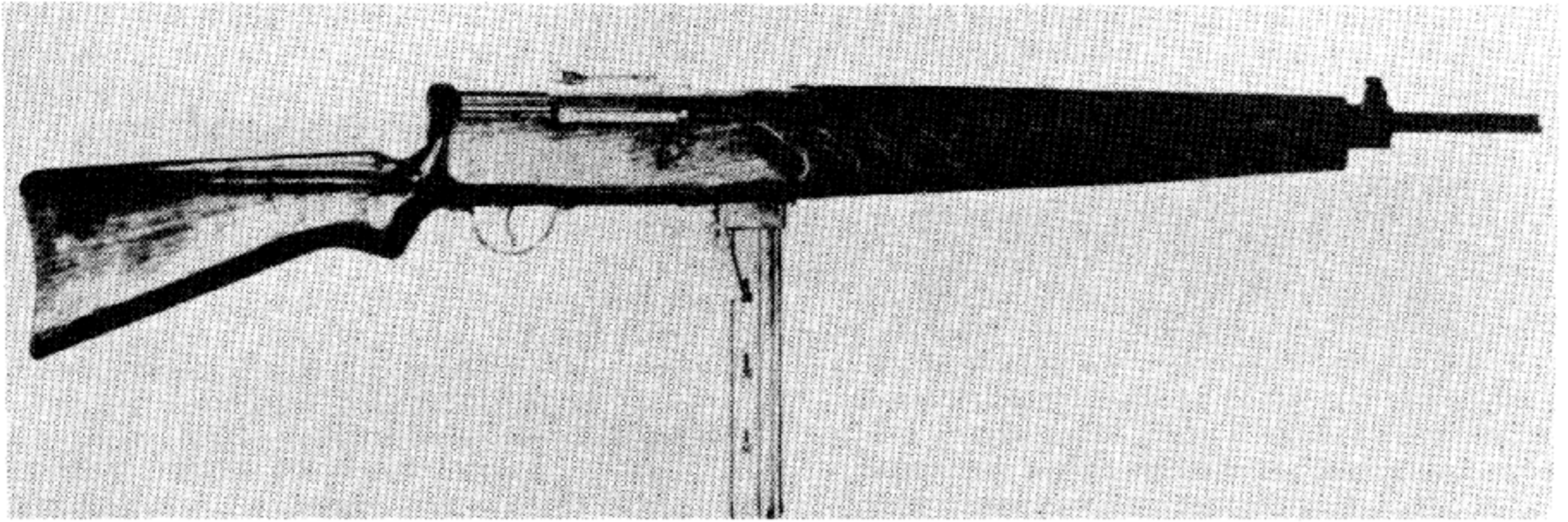

**Caliber:** 9mm Parabellum (Pistol 08).

**Magazine:** Removable box type single line holding 40 cartridges. Note: Magazine positioned directly under receiver. Supported by housing rear guard.

**Weight:** 9 lbs. 2 ozs.

**Sights:** Open, adjustable from 100 to 1,000 meters.

**Ballistic Data:** As the barrel is longer than the Solothurn and Erma types, the velocity, energy, and accuracy range are considerably greater than for those other machine pistols. Cartridges used are, however, identical.

**Operation in Locking:** Same as Solothurn.

**Cooling:** No device provided. Bolt stays open between shots permitting air circulation through breech down barrel.

**Position of Cocking Handle:** Right side as for Solothurn.

**Safety Catch:** On left side of receiver along side rear sight base.

Note: There is also a short barrel Neuhausen with a magazine capacity of 30 rounds and a weight of 9 lbs. 14 ozs. other details being the same.

## LOADING AND FIRING

1. A loaded magazine is inserted in the housing from below the weapon. This is pushed in until it locks.
2. Cocking handle is now drawn straight to the rear as far as it will go. Squeezing the trigger will now fire the weapon. Burst should be as low as possible, not to exceed 5 or 6 shots.

## STRIPPING

At the rear of the action is a milled cap. On the left side is a spring catch which is pressed to permit removing this milled cap. This permits removal of the bolt. No further stripping is normally necessary.

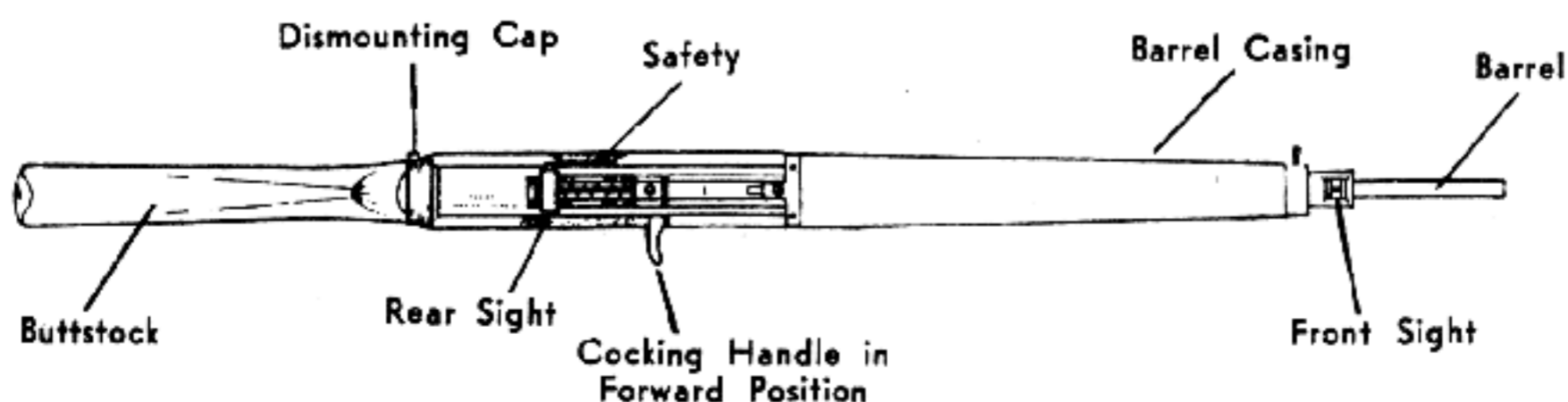

Top View Showing Dismounting Cap, Safety and Cocking Handle Position



# GERMAN BERGMANN 9-MM 1934 MACHINE PISTOL



This is a development of the original machine pistol Model 1918. It is in wide use in the German army, but it is even more extensively used in Russia. This design was the forerunner of practically every sub-machine gun manufactured today except the American Reising.

**Caliber:** 9mm Parabellum (08 Pistol).

**Magazine:** Removable box type, capacity 32 cartridges.

**Position of Magazine:** Right side of weapon pointing slightly towards the front. Earlier models may feed from the left side. Russian type models will commonly feed from underneath.

**Ballistic Data:** Approximately 10% better than for the 9mm cartridge used in the standard pistol. This is because of the extra length of barrel in the Bergmann— $7\frac{3}{4}$ " as against 4".

**Barrel Length:**  $7\frac{3}{4}$ ".

**Overall Length:** 33".

**Weight:** About 9 lbs. without sling.

**Sights:** Fixed front. Open rear with elevation from 50 to 1,000 meters.

**Operation and Locking Data:** Same as for other blow-

backs. This weapon is the original of all the blow-back type submachine guns.

**Cooled:** Has a perforated casing around the barrel which helps radiation and dissipates heat. Bolt stays open between shots, permitting additional air circulation through barrel.

**Cyclic Rate of Fire:** 540 shots per minute.

**Type of fire:** Either single shot or full automatic. A very light pull on the trigger fires **single shot**. Pressing the trigger still **further back** brings the main trigger into action and the weapon fires full automatic.

**Position of Cocking Handle:** A rotating lever with a knob on the end of it is placed at the end of the receiver on the right hand side.

**Safeties:** A thumb operated safety is placed on the left side of the receiver just to the rear and left of the rear sight. **Safe position** is forward when letter "S" can be seen; the **fire position** is to the rear, when the letter "F" is visible. An automatic safety device is incorporated in this weapon which prevents the trigger from being pulled unless the operating handle is locked down.

## LOADING AND FIRING

1. Insert loaded magazine in magazine housing on right side of receiver and push it home until it locks. Note: Magazine release catch is on the rear side of this housing.

2. Turn the bolt handle **up** exactly as for the bolt action type rifle and **pull** it straight back as far as it will go. This cocks the bolt.

3. Now **push** the bolt handle forward and **turn** it back down into its locked position. Note: The bolt

itself will stay back, leaving the ejector port on the left side of the weapon open.

4. This weapon has a unique trigger mechanism. It consists actually of double triggers. Drawing the trigger back slightly to its first position fires a single shot. If the trigger is drawn back as far as it will go, full automatic fire will take place as long as there are any cartridges in the magazine.

## FIELD STRIPPING

1. Turn the cocking handle up as far as it will go and pull it to the rear to its full extent. Now **push down** the vertical bolt stop which rises on the left side of the receiver just at the front of the bolt. This releases the bolt which may now be withdrawn straight back completely out of the receiver. Normally no further stripping is required. Note: Should further dis-

mounting be required, turn the trigger guard locking screws until their cutaway portion lines up with the similar portion of the trigger guard screws. Removing the trigger guard screws will permit the receiver to be lifted off the stock and the trigger housing being pulled out of the bottom of the stock.

## HOW THE BERGMANN MACHINE PISTOL WORKS

The loading magazine being inserted in the magazine housing and pushed in, it is locked by the magazine locking catch. Turning the cocking handle up and drawing it straight back to the rear draws back the bolt which is caught by the sear when it reaches full cocked position and is held there. Pushing forward the cocking handle compresses the recoil spring; while turning the

handle down locks it to the receiver by interrupted screw threads. Pressure on the trigger drives a plunger forward pushing a trigger barrel which forces the sear down out of engagement with the bolt. This trigger plunger now slides off the shoulder trigger bar and releases the sear so it can snap back in position to engage the bolt when it travels rearward from the force of the



# GERMAN BERGMANN 9-MM 1934 MACHINE PISTOL

recoil. Hence the trigger must be released before it can be again squeezed to fire the weapon for the second semi-automatic shot.

If on the other hand the trigger is pulled back at once as far as it will go, it draws back the secondary trigger; as the trigger plunger slides off its bar, a projection in the automatic trigger rotates back and away from the trigger, allowing it to be drawn all the way to the rear. This increased amount of rotation permits the upper part of the trigger bar to push all the way forward, holding the sear down for full automatic fire as long as the trigger pull is maintained. Note: While the cocking handle on this weapon functions in the same manner as the rotating bolt handle on a rifle, it does not duplicate the unlocking action of the bolt action rifle. An explanation therefore is necessary on the operation and functioning of this cocking handle mechanism.

1. The trigger being squeezed, the bolt goes forward

under the compulsion of the compressed recoil spring. The top cartridge in the magazine is stripped unto the firing chamber and the extractor in the bolt snaps over the cannellure of the cartridge because it is chambered.

2. However, just before the bolt reaches its fully forward position, the hammer comes in contact with a projection on the bottom of the receiver which compels the hammer to rotate and drive the firing pin forward to fire the cartridge.

3. As the bolt travels rearward under the force of the recoil, the extractor draws out the empty cartridge case and it is hurled out of the left side of the weapon. The empty case strikes a rigid ejector, which in this weapon is in the rear of the magazine slide on the right side of the receiver.

4. The recoil spring is compressed, and at the end of the motion the recoil spring guide over which the spring compresses, strikes the buffer spring and stops the recoil of the bolt.

## NOTE ON OTHER MODELS



In the Bergmann Machine Pistol No. 18-1, the magazine is fed in from the left side on a slant to the rear, and either a straight box or the special Luger snail-type magazine may be used. Cocking handle on this type is on the right side of the weapon and functions exactly as does the Schmeisser. The safety is a locking recess at the end of the cocking handle slot, into which the

cocking handle is turned to lock it. The cooling jacket design is not as efficient in this model as in the later ones.

**Note:** Bergmann machine pistols have compensators built into the barrel.

This model Bergmann is widely used by the Russians. It is also used by the Japs.



# GERMAN 7.92-MM 41 AND 41-W RIFLE



## The New German Semiautomatic Rifle

**Caliber:** 7.92mm German Service cartridges.

**Magazine:** Fixed rectangular box extending below the stock at front of the trigger guard.

**Magazine Capacity:** 10-cartridges.

**Overall Length:** 45 inches.

**Weight:** 10 lbs. 14 ozs.

**Sights:** Leaf rear sight, graduated from 100 to 1200 meters.

**Gun Operated By:** Gas. Barrel is **not** tapped as in most gas operated weapons. As bullet leaves barrel, expanding gas is trapped in a cone attached to the muzzle. Gas drives back a floating piston, operating

the gun.

**Locked:** Securely locked at moment of discharge.

**Cooled:** Air.

**Position of Cocking Handle:** Right side of rifle.

**Type of Fire:** One shot for each pull of the trigger.

**Safety:** Thumb safety catch extends from rear of receiver. Turned to the right it is "Safe." Turned to the left it is ready to "Fire."

**Bolt Release Stud:** On left side of rifle in stock above the rear end of the magazine. When weapon is open, pressing this stud will release the bolt and permit it to go forward.

## LOADING AND FIRING



Pull back cocking handle as far as it will go. Magazine follower will rise and hold the weapon open. Place a clip in the magazine clip guide and force the 5-cartridges down into the magazine. Insert a second clip in the clip guide and strip the next five cartridges down to fill the magazine.

Push in the stud on the left side above the rear of the magazine. This will release the bolt which will be driven forward by the recoil spring, permitting the bolt to strip a cartridge from the magazine and feed it into

the firing chamber.

Pressing the trigger will now fire the cartridge in the chamber; the gas caught in the trap at the muzzle will operate the action to unlock the bolt and eject the empty shell, compress the recoil spring and permit the magazine spring to force the next cartridge up into line to be driven forward by the bolt in forward motion. This operation will be repeated at each pull of the trigger.

## FIELD STRIPPING

Pull the cocking handle back as far as it will go to open the breech.

Press the locking bolt over to the right. This bolt operates through the cover just ahead of the cocking handle in the forward position, to hold the mainspring compressed.

Set the safety catch at the safe position; this is done by rotating it to the right.

At the rear end of the breech block is a locking plunger. Push this plunger in and raise the rear end of the block; this permits the breech block to be withdrawn from the receiver.

Turn the safety catch to the fire position and press

the trigger to release the catch on the hammer.

A small plunger in the sight base locks the muzzle cap; pressing this in permits the cap to be unscrewed and the gas cylinder and piston to slide out the front.

Removing the upper and lower bands permits release of the hand guard. Next the operating rod is lifted from its seat. Then the recoil spring assembly is lifted out of the stock.

The magazine is removed as for the U. S. Springfield Rifle.

**Note:** The bolt, slide, and the slide and receiver groups may be lifted out by locking the slide in its full forward position.



# GERMAN 7.92-MM 41 AND 41-W RIFLE

## FIELD ASSEMBLY

Turn the safety catch to the "Fire" position.  
Push the hammer down until it engages with the bent of the sear.

Turn the safety catch to the safe position (right).  
Insert the breech block in the receiver, holding the front end down and move it slightly to the front. Push in the

plunger at the rear end which will permit the rear of the breech block cover to position properly in the receiver.

Release the pressure on the plunger and turn the safety catch to the left.

Press the release stud to close the weapon.

## HOW THE GEWEHR 41-W WORKS

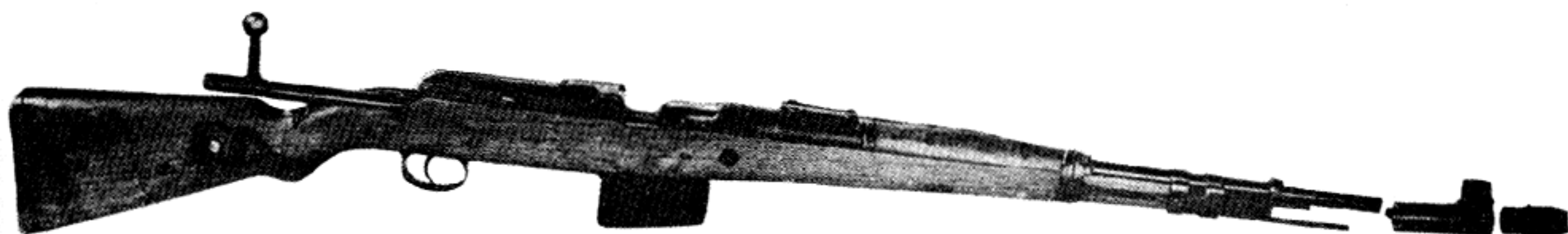

This rifle does not have a gas port tapped in the barrel. Instead a gas-trap, cone shaped, is screwed onto the muzzle.

As the bullet leaves the barrel, it jumps a gap which for just an instant permits the gas to stop up the muzzle end of this cone.

The pressure thus trapped rebounds against the gas piston which fits around the barrel end, and against the rear of the blast cone.

This pressure thrusts back the floating operating rod which rests against the cylindrical piston working on top of the barrel and under the hand guard below the rear sight base.

The end of this operating rod touches the front end of this slide and hence drives it to the rear under the force of the back pressure.

The travel of the operating rod is only about 1 1/2" but the blow imparted to the slide is stiff enough to drive the action back against the tension of the recoil spring.

A projection on the bottom of the slide engages with locking lugs inside the bolt. For the first half inch

of its travel it does not affect the lock which gives sufficient time to permit the high breech pressure to drop. Then it cams the lugs inward out of their recesses in the receiver, thus unlocking the rifle and permitting the assembly to travel straight back to the rear to eject, compress recoil spring, and prepare for forward motion of loading.

As the bolt assembly and bolt go back together, the bolt carrying the empty cartridge case gripped by the extractor, the case strikes the ejector and is tossed out of the breech. Then the bolt rides over the hammer to cock it and a cam on the bolt forces it down until it is engaged by the sear.

At that point the recoil spring comes into play driving the bolt forward to strip a cartridge from the top of the magazine and feed it into the firing chamber, while the projection on the slide cams the bolt locking lug into the recesses in the receiver.

The weapon is now ready for a press of the trigger. Remember that this rifle, like our Garand, fires from a closed bolt.

## NOTES ON THE GERMAN GEWEHR 41



While this is an excellent type of semi-automatic rifle, it does not compare in simplicity or ruggedness with our own rifle. It is interesting to note however, that the Germans in experimenting with such a weapon have also hit upon the gas operated principle.

The 41 and 41-W are **standard** rifles; the 41M is so infrequently met with that it is considered merely experimental and does not warrant attention here.



# GERMAN 7.92-MM 41 AND 41-W RIFLE

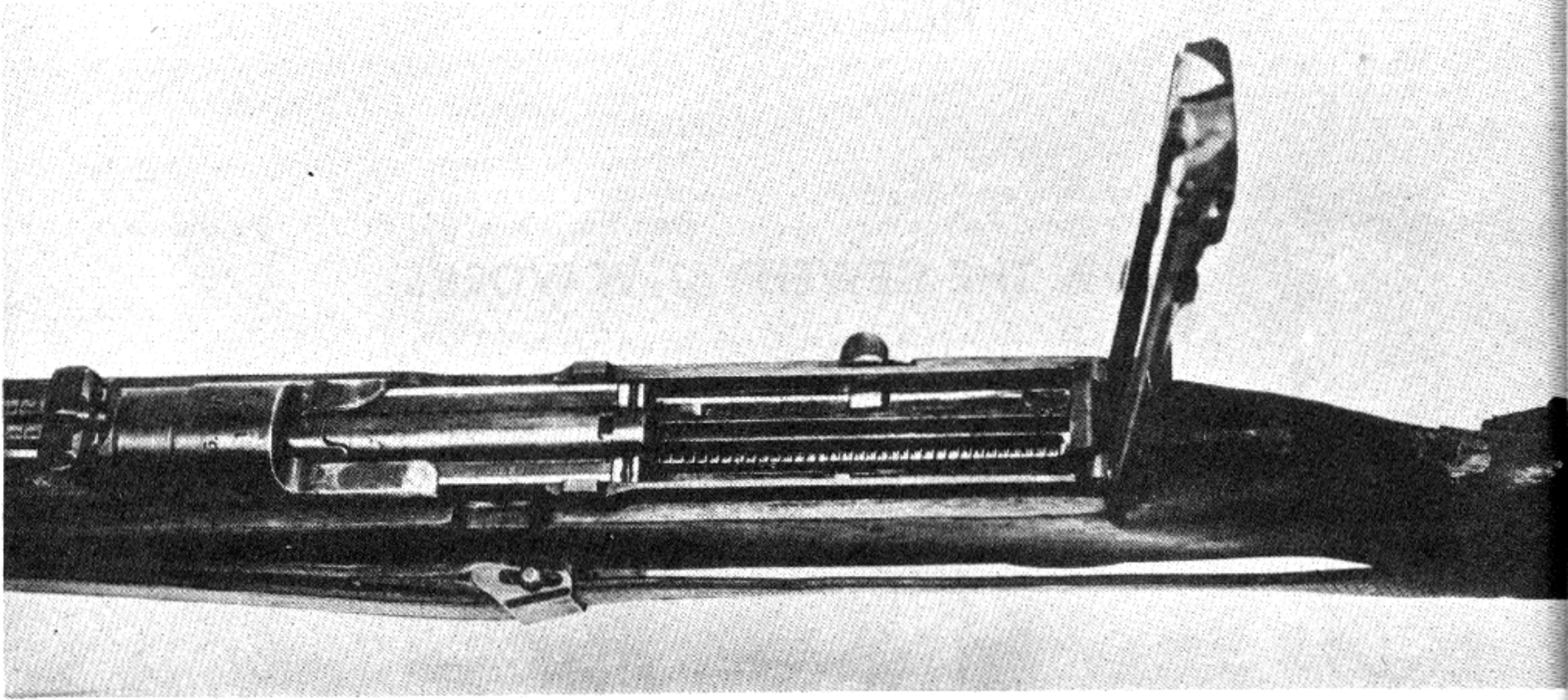

Bolt Cover open, Showing Detail of Bolt and Recoil Spring.

# GERMAN 7.92-MM GEWEHR 42 AUTOMATIC RIFLE

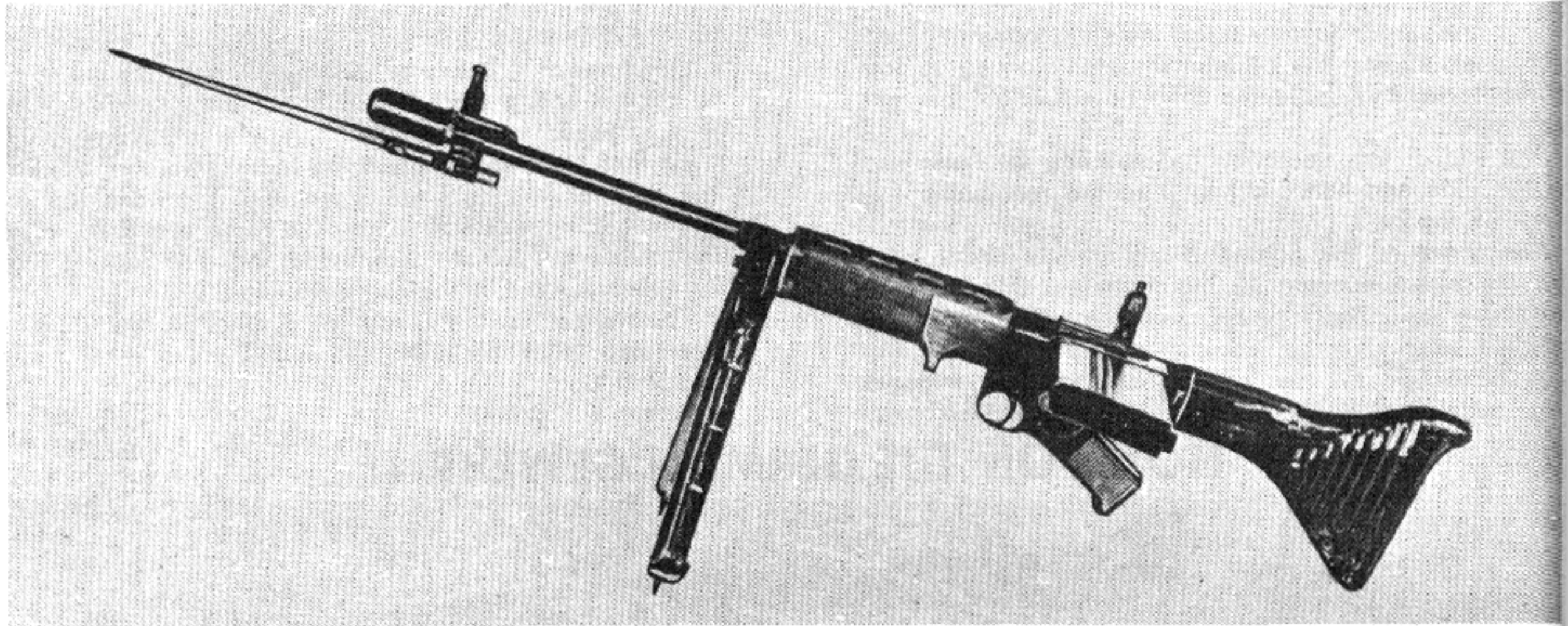

Note: This is a revolutionary military development. It is a paratroop weapon, fitted with a folding bipod mount. When fired semi-automatically, the bolt is in full forward position, which permits maximum accuracy as a rifle. When the change lever is moved to permit full automatic fire, the bolt remains open when the trigger is released to permit cooling, thus giving the full value of a light machine gun. It will be noted that this weapon uses the short gas-stroke of a type originally developed for our Winchester carbine.

**Caliber:** 7.92mm.

**Magazine:** Arc-shaped, inserted on left side.

**Magazine Capacity:** 20 cartridges.

**Barrel Length:** About 19 inches.

**Overall Length:** About 42 inches (without bayonet).

**Weight:** 9<sup>3</sup>/<sub>4</sub> lbs. without magazine.

**Sights:** Special folding post sights for both sniping and automatic firing.

**Cocking Handle and Change Lever:** Right side of receiver.

**Locked:** By turning bolt, Solothurn system.

**Operation:** Gas on short stroke principle.



# GERMAN MAUSER 7.92-MM 98 RIFLE AND 98K CARBINE

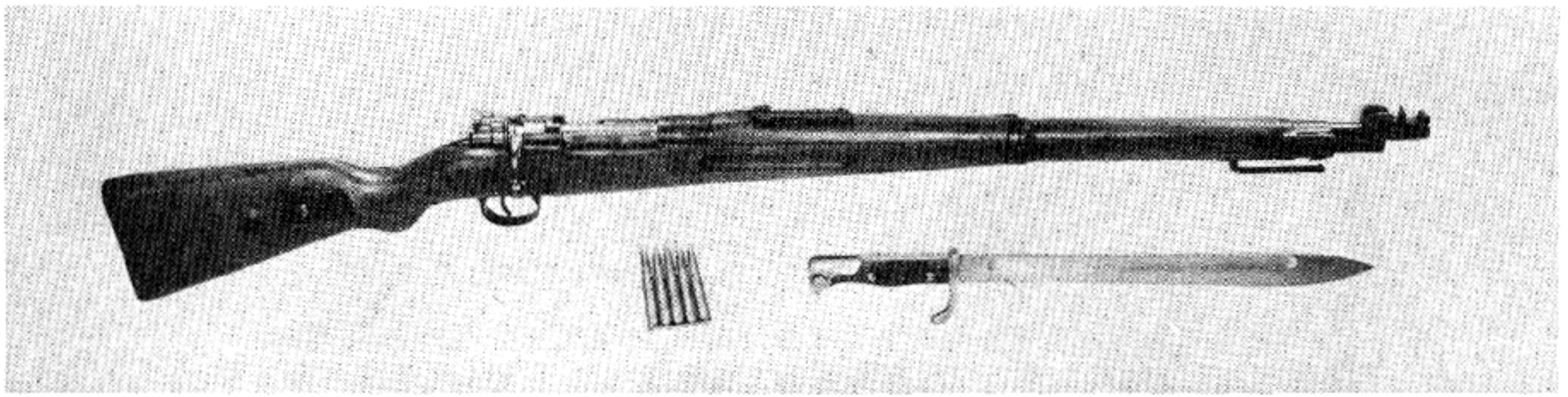

(Note: Our own Springfield Rifle was patterned after this weapon. The Mauser system is the most widely used military rifle system in the world. Bolt action rifles, however, are now being replaced in the German Army by semi-automatic rifles. It is interesting to note that the new semi-automatics use the gas operation principle, as do our Garands.)

**Caliber:** 7.92mm.

**Magazine:** Staggered-box type as for Springfield Rifle.

**Capacity:** Five cartridges.

**Muzzle Velocity:** About 2800 feet per second.

**Barrel Length:** 29.15 inches.

**Length without Bayonet:** 4' 11/2".

**Weight of Rifle:** About 9 lbs. (with sling).

**Sights:** Barleycorn type front, open V notch rear, adjustable from 400 to 2000 meters.

**Magazine Cutoff:** None provided.

**Locked:** Turning bolt action. This is the original Mauser locking system.

**Safety:** On rear of cocking piece same as for our Springfield Rifle Swung over **to the right** it is "safe." Has same type of mechanical safety to prevent weapon from firing unless bolt is fully closed as is found in our Springfield.

## CARBINES

The rifle described above is in general use in the German army together with two shorter carbine models, known as the Model 98B, long barrel carbine (the length is about the same as for the Model 98), and the short barrel carbine, known as the Model 98K.

## MAUSER CARBINE, MODEL 98K

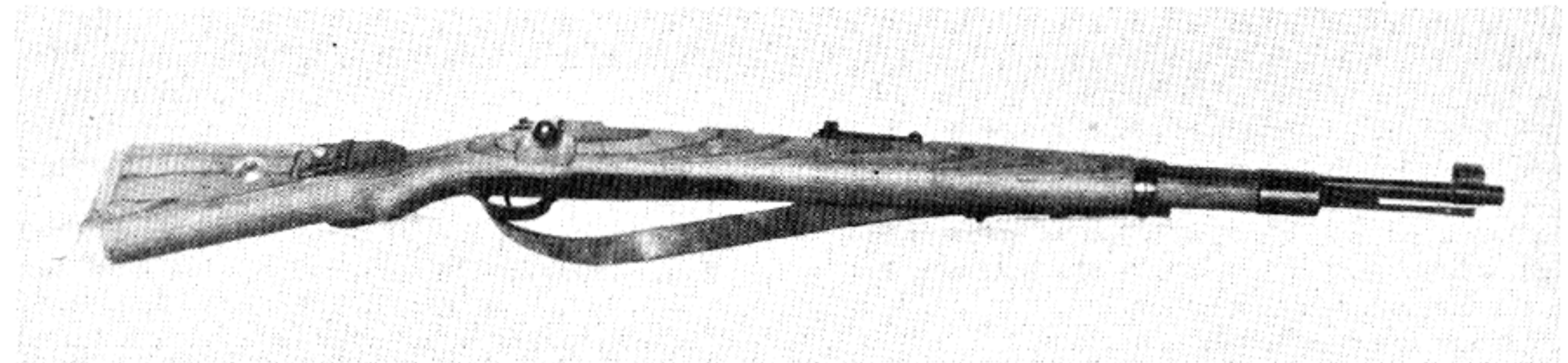

Barrel length on this weapon is about 23 1/2". This weapon works about the same as the Springfield rifle, except that there is no magazine cutoff. The short stock has a semi-pistol grip with sling on the left side for carrying rifle. This sling is not used as in our rifles as an aid to firing. Sights on this weapon are graduated from 100 to 2000 meters. A metal lined hole on the left side

of this stock is provided to insert the firing pin to protect it when the bolt is being stripped. A cleaning rod is fitted into the stock below the muzzle.

**Effective Ranges for This Weapon:** About the same as for the Springfield.

**Loading and Firing:** Same as for U. S. Rifle caliber 30, Model 1917.

## FIELD STRIPPING

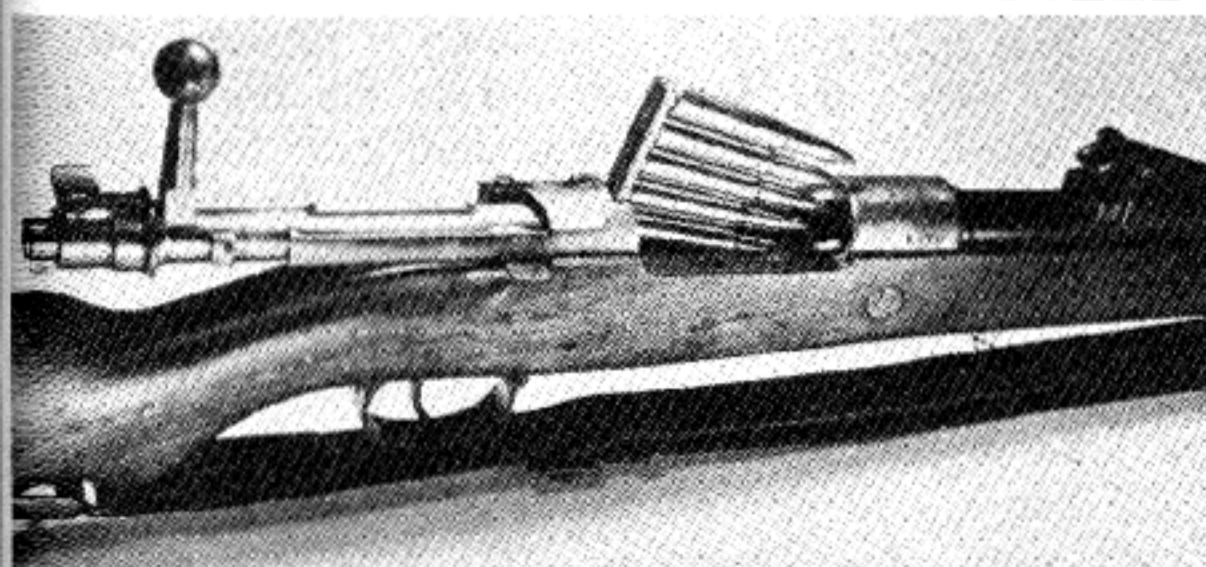

1. **To remove bolt.** Proceed as for U. S. Rifle Model 1917. With rifle cocked and safety lever vertical, half way between safe and locked position, pull out near end of bolt stop on left side of receiver and

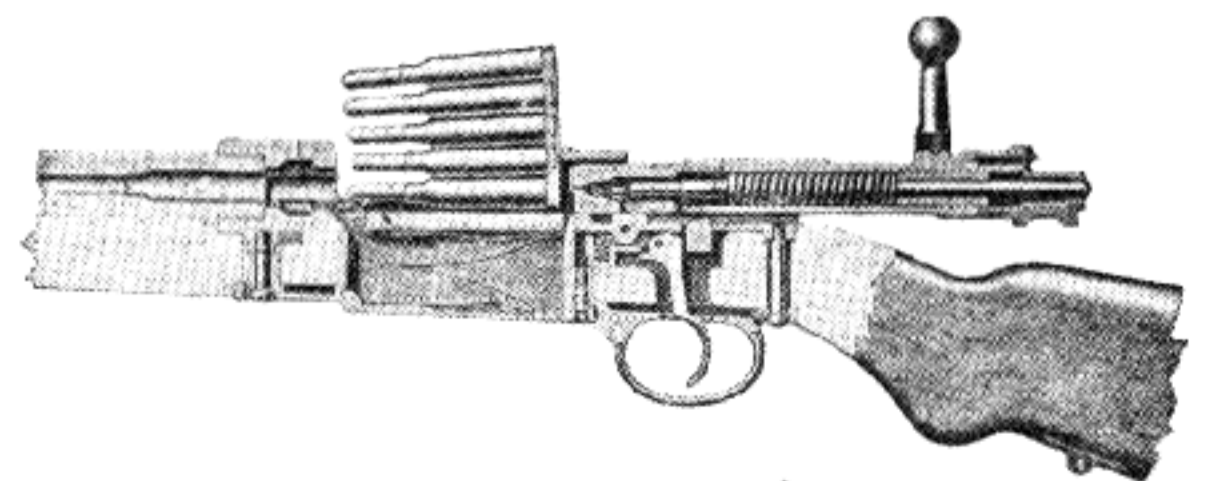

draw bolt straight out to the rear.

2. **To dismount bolt.** Proceed as for Springfield.

3. **To remove magazine mechanism.** Same as for Springfield.



# GERMAN 7.92-MM 42 LIGHT MACHINE GUN

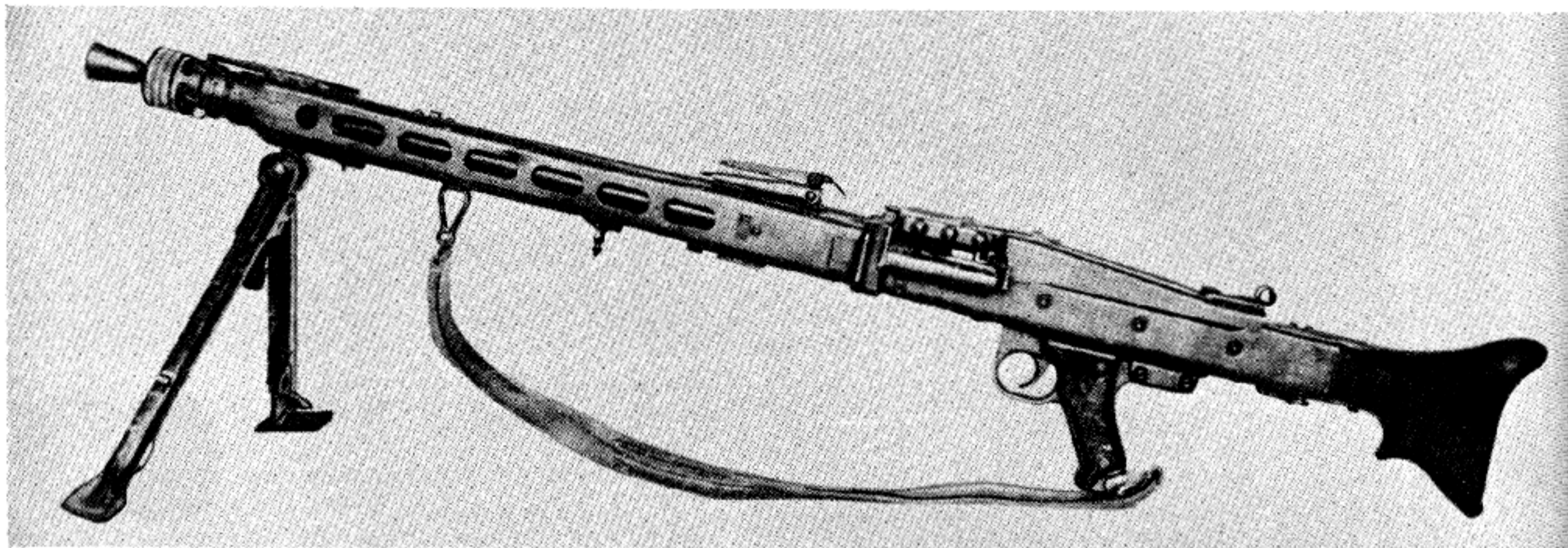

This is the latest German machine weapon. In many respects it is the most remarkable gun of its type ever developed. The cheapness and simplicity of its manufacture, as well as its superior performance, will probably lead to its supplanting the MG-34.

Following in the footsteps of the Russians, the Germans in developing this gun ignored all the shibboleths of machine gun designing. The result is an all purpose machine gun which can be produced cheaply and rapidly and which is amazingly simple and reliable. Like MG-34, it has the one defect of trying to be too many weapons. With a bipod mount it can be used by one or two men. On an antiaircraft mount it is a truly excellent antiaircraft gun. On a tripod mount it fills many of the uses of the heavy or medium machine gun. However, the rate of fire is so very high (a very valuable characteristic for antiaircraft work) that the weapon suffers as a ground-pattern light machine gun. It wastes ammunition and climbs entirely too much to utilize the accuracy inherent in the German service cartridge.

**Caliber:** 7.92mm German Service Cartridge.

**Feed:** Non-disintegrating 50-shot steel belts, which can be linked together to give any capacity desired; or 50-shot belts wrapped in individual steel drum as for the MG-34. Like the MG-34, also, some models are fitted to receive the saddle type dual drums holding 75-cartridges, one drum on each side of the receiver with a solid connecting piece joining them across the bridge of the receiver.

**Ballistics:** Standard for this cartridge.

**Weight of Gun With Bipod:** About 25 lbs.

**Sights:** As for MG-34. Has special attachments for anti-aircraft sight. Telescope sight provided for use with tripod. This is mounted on the tripod, not on the gun.

**Gun Operated by:** Short recoil and muzzle booster as

for MG-34.

**Locked:** By a unique locking system. The essential principle had previously been utilized in an automatic rifle of Mannlicher design. However, the development of this principle in the MG-42 is quite new. There is no rotating lock in this gun nor any rising or falling wedge systems. The bolt is securely locked to the barrel by two locking studs in the bolt head which are free to move under the action of locking cams on the barrel extension.

**Cooled:** Air; bolt open between shots. Heavy ventilated barrel casing.

**Cyclic Rate of Fire:** 900 to 1200 per minute. With some types of ammunition, this gun is capable of a speed close to 1500 per minute. This speed is too high for any practical use except on or against aircraft.

**Type of Fire:** Full automatic only.

**Flash Hider:** On end of barrel casing as in MG-34.

**Barrel Removal:** This is probably the most remarkable feature of the gun. On the right side of the barrel casing where it joins the receiver is a spring catch. When the gun is cocked, a forward and outward push on this catch with the heel of the hand will lever out a hinged side-piece which will bring the rear end of the barrel completely out of the gun. If the gun is so mounted that the muzzle can be elevated and the butt depressed, the barrel will slide out of its own accord. If the gun is level the extension on the barrel may be quickly grasped and the barrel whipped out of its seating. Inserting the muzzle of a new barrel through the hole in this lever and pushing it forward until its muzzle enters the forward end of the barrel casing, then slamming the side piece shut, locks the barrel in position to resume firing. No weapon made compares with this one on barrel change.



# GERMAN 7.92-MM 42 LIGHT MACHINE GUN

## LOADING AND FIRING

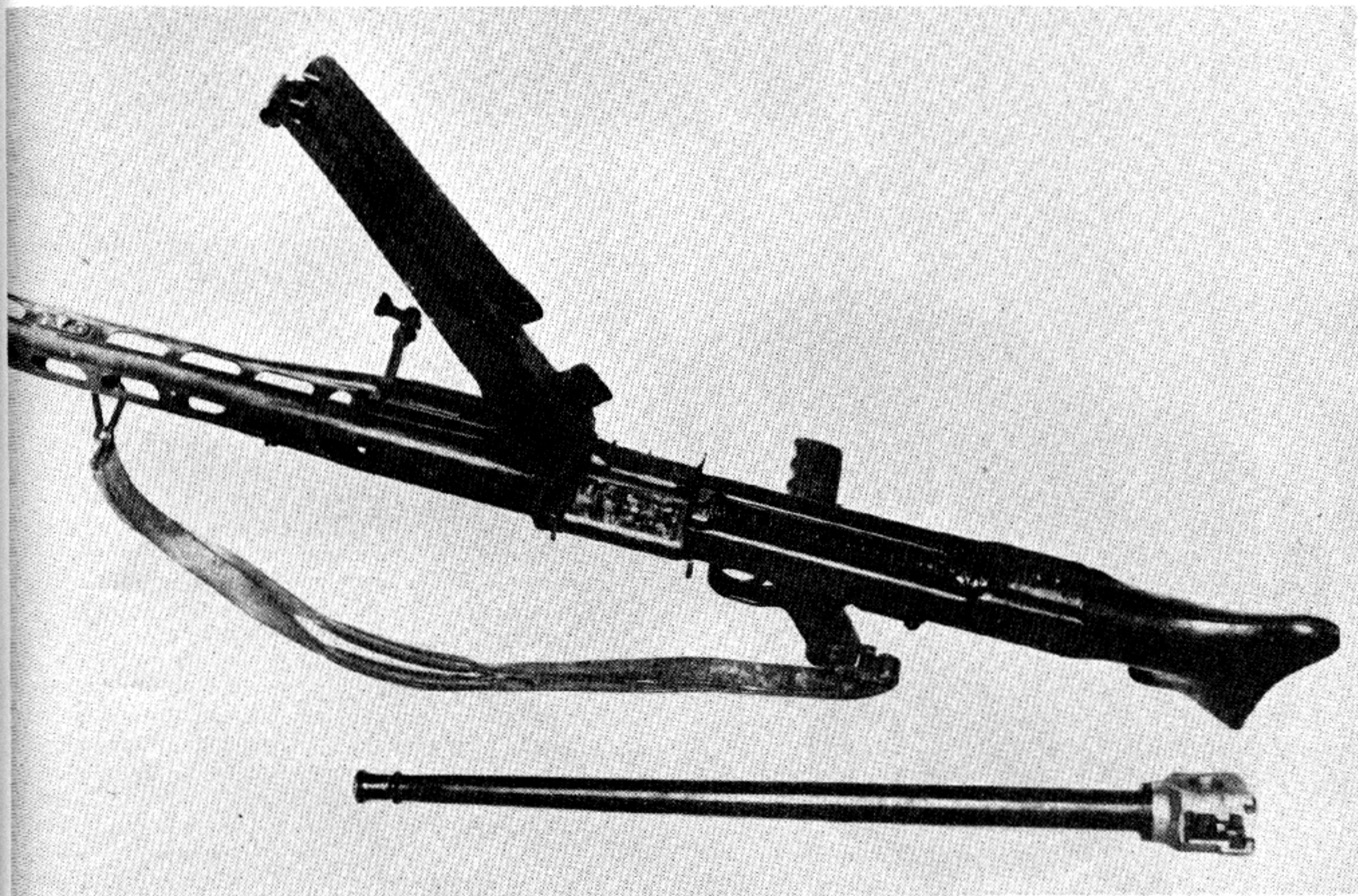

**To Load:** As for MG-34. Feed cover may be open or closed. Be sure that the first cartridge rests against the stop on the right side of the feed guide.

Pull back cocking handle on left side of gun as far as it will go. The bolt will stay open. Then shove the cocking handle fully forward until it clicks.

Unless gun is to be used immediately, set the safety. On this gun the safety is just above the pistol grip. Push the button from the **right** hand side, and it sets the safety. Push the button on the **left** hand as far as it will go and the gun is ready to fire.

**Notes on Unloading:** Unloading this gun is a very sim-

ple operation. First pull back the cocking handle as far as it will go. Then set the safety. Push forward the cover catch and raise the cover as high as it will go. Lift the belt out of the gun.

It is not good practice to permit the bolt to go home on an empty chamber. Always hold the cocking handle firmly while pressing the trigger and ease the bolt into forward position.

Note that there is a spring cover over the ejection opening in these guns. It flies open when the trigger is pressed. On "Cease Fire" always push it shut. This will keep dirt and dust out of the mechanism.

### FIELD STRIPPING

In general field stripping this gun is similar to the MG-34. There are however some few differences.

**Remove Barrel.** It is first necessary to cock the weapon. This is done by pulling back the cocking handle. Then thrust forward and outward on the heavy release catch jutting out from the rear of the barrel extension on the right hand side of the gun, below the feed block. This draws the rear of the barrel out of its seat and permits it to be drawn from the rear of the gun.

**The feed is the same as on the MG-34.** Push forward the feed cover catch on top of the gun near the stock and lift the cover. Pull out the feed cover hinge pin and remove the feed block from the gun. Dismounting this is very simple.

**Remove buttstock, same as for MG-34.** Catch is on the under side of the stock. Push it and twist the butt a quarter turn, right or left, and control the rearward motion as the heavy recoil spring forces it backwards.

**Remove buffer and recoil spring.** As in the MG-34, the housing catch is on the rear end of the receiver, just back of the pistol grip. Press the catch and control the buffer housing that moves away from the receiver under tension of the powerful spring.

**Remove the bolt.** Press the trigger and **strike the cocking handle a sharp rearward blow.** This will drive the bolt to the open rear of the receiver where it may be withdrawn.



# GERMAN 7.92-MM 42 LIGHT MACHINE GUN

## HOW THE GUN WORKS

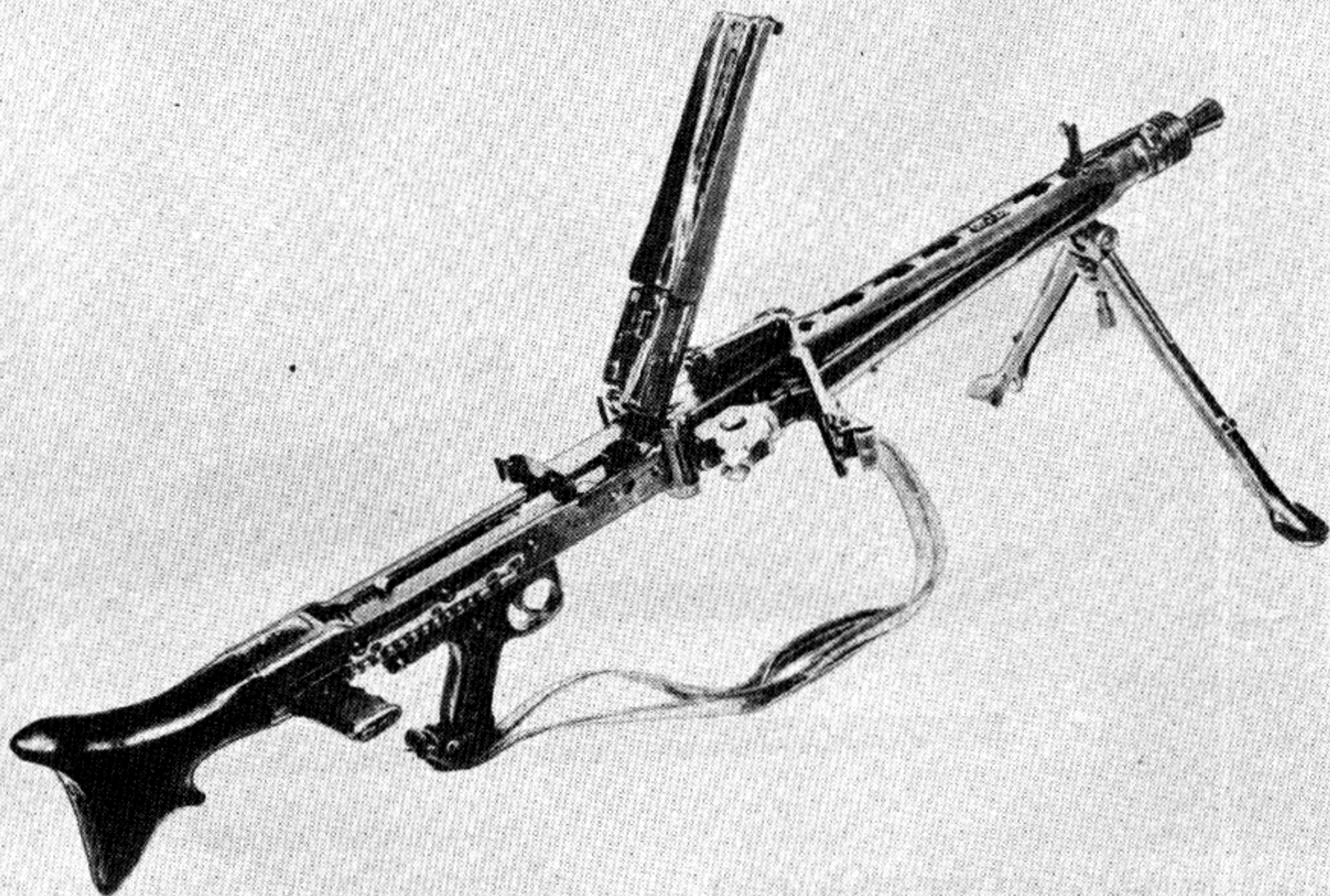

In general this gun follows the operating detail of the MG-34.

However, an entirely new design of bolt and locking mechanism is employed. The barrel and bolt in this gun travel back in a **straight line** during the period of recoil. There is no turning action.

A heavy barrel extension is screwed on to the chamber end of the barrel. In its sides are slots into which cams are machined. As the bolt goes forward, a movable locking stud on each side of the front end of the bolt strikes a corresponding cam in the barrel extension forcing locking lugs out and into slots in the barrel extension, as the face of the bolt comes flush with the base of the cartridge in the firing chamber. The extractor slips over the base of the cartridge. The firing pin, mounted in the rear of the bolt assembly, is driven for-

ward to explode the cartridge. Note that a stud driving from the top of this rear bolt assembly, travels in a groove in the curved feed arm and shuttles the feed across and back to operate the feed mechanism.

During the recoil movement, barrel extension and bolt are firmly locked together during the moment of high breech pressure. Then as the barrel extension and barrel are stopped in rearward travel, the studs on the bolt head are cammed out by the camming surfaces on the barrel extension and the locking lugs are thus withdrawn from their seats in the barrel extension permitting rearward direct line motion in the action. This action is patterned after a simple pile-driver. The bolt resembling the pile-driver hammer being pulled up (or out) to its full extent, then the gripping surfaces being cammed out to release it.



# GERMAN 7.92 34 LIGHT MACHINE GUN

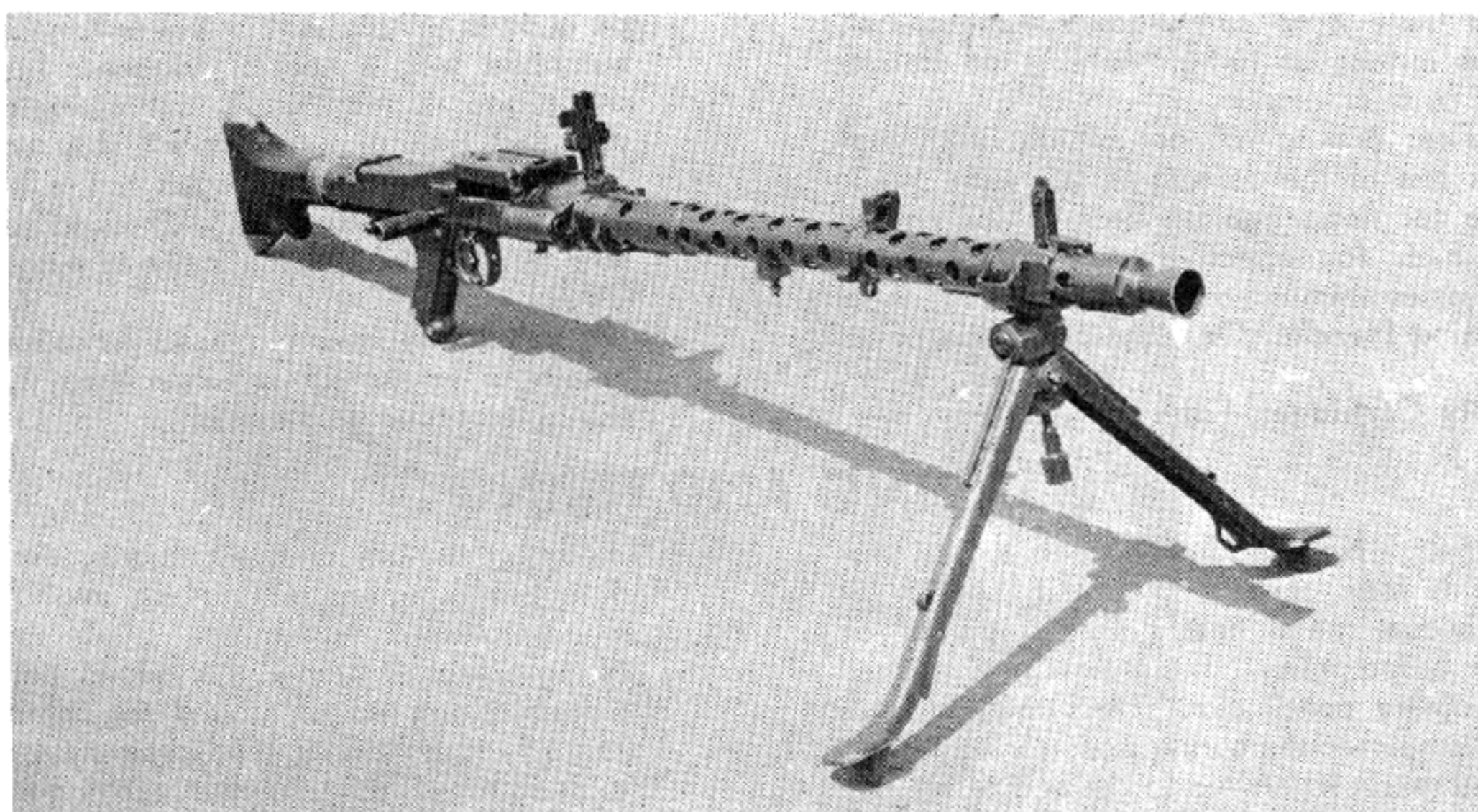

The Treaty of Versailles prohibited the Germans from manufacturing heavy machine guns. Their way around this restriction was to develop an all-purpose machine gun which could officially be called a light machine gun, but which had the necessary characteristics built into it, to enable it to be used as an anti-aircraft gun or in a special mounting as a heavy machine gun. Originally, a light machine gun was a weapon with a magazine capacity of 20 or 30 cartridges, and a light, not easily removable barrel. Thus it could not be used for sustained firing nor was it valuable for long range use as a tactical weapon.

With the facilities of the Solothurn factory in Switzerland, the Germans were able to develop a light weight machine gun whose barrels could be changed so rapidly that the disadvantage of overheating was completely eliminated. This compensated for the heavy weight and water cooling devices necessary on the typical heavy machine gun. By developing a special metal link belt whose sections can be fastened together speedily to provide a belt of any length, they overcame the factor of feeding. By developing a special form of mount in which the excessive recoil of the gun in continuous operation is utilized to work the elevating movement, when mounted in a heavy tripod, they made the weapon suitable for long range searching fire.

This weapon can be used by an individual or by a gun crew of three or more men. Each gun is issued with three spare barrels. These barrels can be changed in a matter of seconds.

This is the most widely used machine weapon in the German Services at the present time.

However, a new light machine gun, somewhat resembling this one in exterior appearance but however far surpassing this simple design in simplicity, reliability and ease of manufacture, was introduced to the German Services in 1942.

In passing it should be noted that the L. M. G. 34 is intended as an all-purpose weapon. No gun in this particular class has yet been developed in the United States. In Great Britain, the Bren Gun has been utilized along these lines.

**Caliber:** 7.92 German Service cartridge.

**Feed:** (a) Metal belt feed is normal. Capacity of belt is 50 rounds. Any number of belts may be fastened together.

(b) In tank and anti-aircraft uses, this gun may be fitted with a 50-round belt contained in a drum type magazine, attached to the left side of the feed block.

(c) On anti-aircraft types of this kind, a saddle-type drum is used. In this type, which holds 75-cartridges, two drums are connected by a center strip which locks down over the feedway so that a drum lies on each side of the receiver.

**Barrel Length:** 23½".

**Overall Length of Gun:** 48".

**Weight:** 26½ lbs. with the attached bipod mount.

**Sights:** V-notch rear is graduated from 200 to 2,000 meters. A folding peep on the rearsight may be used with an anti-aircraft ring. Also an anti-aircraft air sight is issued which fits on the barrel jacket. A telescope sight is also provided for mounting on the tripod when gun is used as a heavy machine gun. This is graduated to 3500 meters.

**Effective Range of the Gun:** German sources claim 2000 yards used with the bipod and about 3800 yards with the tripod mount.

**Maximum Range:** About 5000 yards.

**Ballistics:** Standard for type of German cartridges employed. Muzzle velocity may vary from 2500 to 3000 feet per second.

**Gun Operated By: Recoil.** (A special recoil booster screwed onto the muzzle causes some of the expanding gases that follow the bullet after it has left the barrel to rebound against the face of the barrel, thus speeding up the rearward action of the recoiling parts.)

**Locked:** Breech block is firmly locked to the barrel at the moment of firing by interrupted screw threads.

**Cooled:** Air. Barrel is mounted in a fixed barrel jacket or casing which is perforated. This gun fires from an open bolt. As it stays open between shots, air can circulate through the breech opening and the



# GERMAN 7.92 34 LIGHT MACHINE GUN

barrel. Since there is no cartridge in the chamber, except at the instant of firing, there is no danger of a cook-off in this weapon.

**Cyclic Rate of Fire:** 800 to 900 per minute. This high rate of fire is one of the defects of this gun. While it is desirable for firing against aircraft, the rate is entirely too high for effective use as a ground weapon. It wastes ammunition.

**Position of Cocking Handle:** On right hand side of receiver.

**Ejection of Empty Cartridge:** From bottom.

**Type of Fire:** Single shot or full automatic. This gun is equipped with a special trigger. The top part of this trigger is marked "E." Pressing it will fire one shot and then the weapon will stop until the trigger is released and pressed again. The bottom part of the trigger is marked "D." Pressing this bottom half lets the gun fire automatically as long as the trigger is held back.

**Safety:** A safety lever is placed just above the trigger. Pushing it to the "S" position locks the sear so that the bolt cannot go forward.

## LOADING AND FIRING

Loading the belt. No machine is needed nor provided to load this form of belt. The belt consists of a series of individual metal links, joined together by small pieces of coiled wire. These links are shaped much like an ordinary pencil clip. Press the cartridge down into the clip so that the spring sides spring around the cartridge and retain it. A nib at the end of the clip will spring into the cannellure of the cartridge and hold it in the correct position. It will be evident that in this form of belt there can be no malfunction of the type

so common to web belts which may expand when wet and to brass-studded belts which must pass through a complicated feed mechanism.

In the 50-round drums, the loaded belt is inserted in the drum, being wound around the center piece.

The 75-round, saddle type drums, do not use a belt. The drum itself contains the cartridges. The springs force them around into position, one coming alternately from each side.

## TO LOAD THE GUN

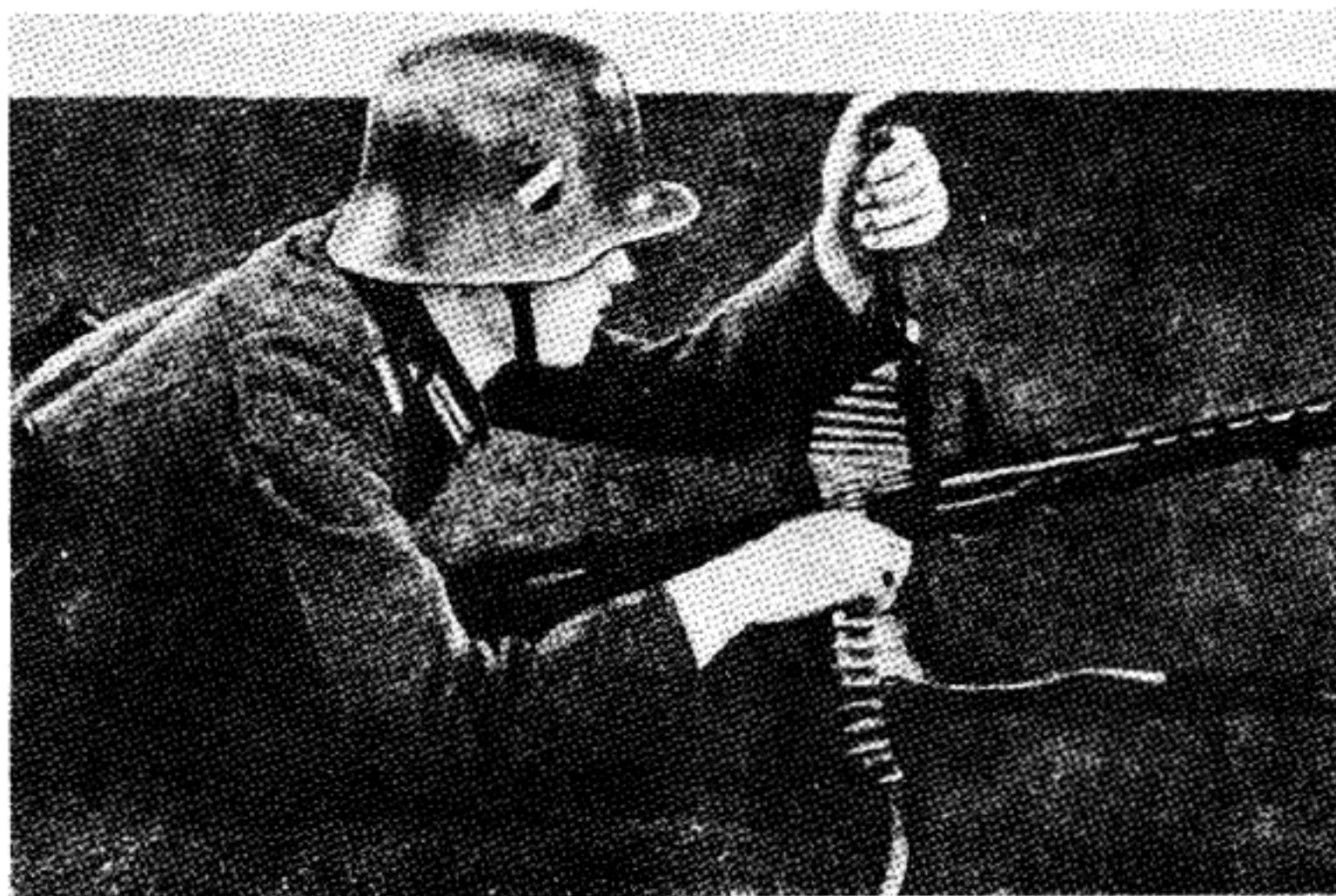

Tabs are provided on the end of each belt. If several sections are being fastened together, or if no tab is available, then the first two or three cartridges should be removed from the metal belt.

Insert the feeding end of the belt in the feedway on the left side of the receiver, and pull through as far as it will go.

**Warning:** Unlike the Browning and the Vickers, the belt on this gun lies **on top of the cartridges** as they pass through the feed block. An alternate way of loading is to push forward the cover catch (which is on top of the receiver at the rear of the gun) and lift the feed cover to vertical position. The belt may then be laid in the feedway; make sure that the first

cartridge rests against the stop on the right side of the guide. Close the cover and snap it down in place.

Pull back the cocking handle as far as it will go and the bolt will be caught and held in rearward position by the sear. Now **push the cocking handle forward** as far as it will go. If this is not done it will be carried forward as the bolt moves to the front, and this additional weight may cause malfunctioning.

Pressing the upper part of the trigger will now fire a shot. Pressing the lower part of the trigger will fire the weapon full automatically.

**Note:** If the cocking handle will not come back, it indicates that the safety is on. Move the lever to the "Fire" position.



# GERMAN 7.92 34 LIGHT MACHINE GUN

## FIRING WITH THE 50-ROUND DRUM

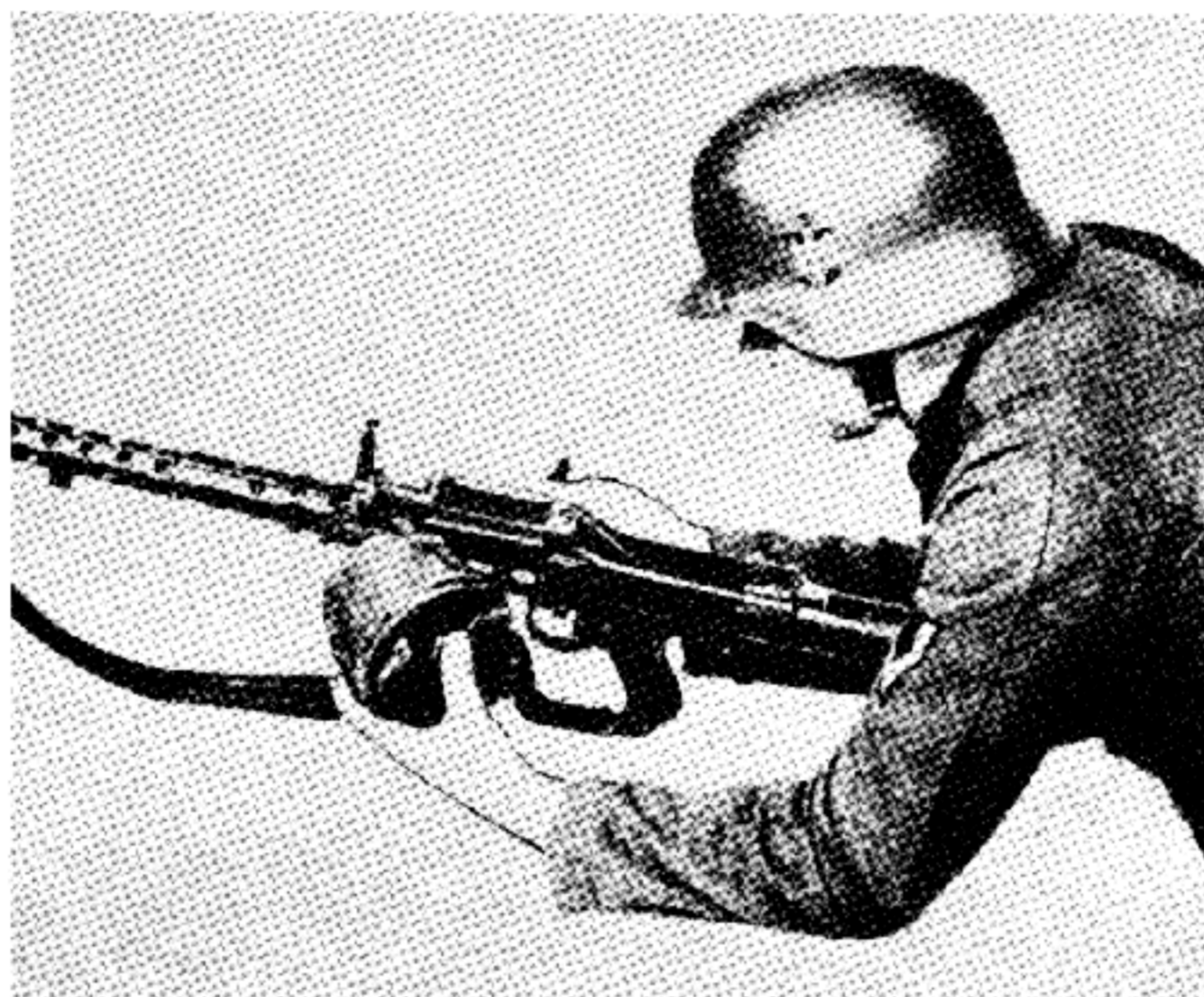

Press the catch on the sliding cover of the drum and open the cover so that the tag end of the belt can be pulled out. Insert the tag of the belt in the feedway as for the ordinary belt. The narrow end of the belt is the front end. Engage the hook on the front end with

the lug on the rear end of the lower part of the feed plate. Now swing the rear end of the drum around until the spring catch engages with the lug on the rear end of the feedway. Pulling back the cocking handle now leaves the weapon ready for firing.

## 75-ROUND SADDLE DRUM

These drums are normally issued with a gun having a special feed block. Belts are not used in this type of feed. The drum is placed directly over the receiver ahead of the trigger guard. Its center piece pushes

down the dust cover in the receiver. A spring catch at the top center of the connecting piece can be pressed to release the drum and a hand-strap is provided to lift it off the gun.

## FIELD STRIPPING

One of the outstanding characteristics of this gun is the extreme ease of barrel removal. The gun is normally issued with three spare barrels. The barrel will normally be changed after continuous or fairly rapid burst fire of 250 rounds. However in emergency this gun has been known to fire 400 rounds without serious trouble

due to overheating. This compares favorably with water-cooled guns.

Pull the cocking handle back to cock the weapon. Now push the safety lever (on the left side of the receiver above the trigger) to the position marked "S" for safe.

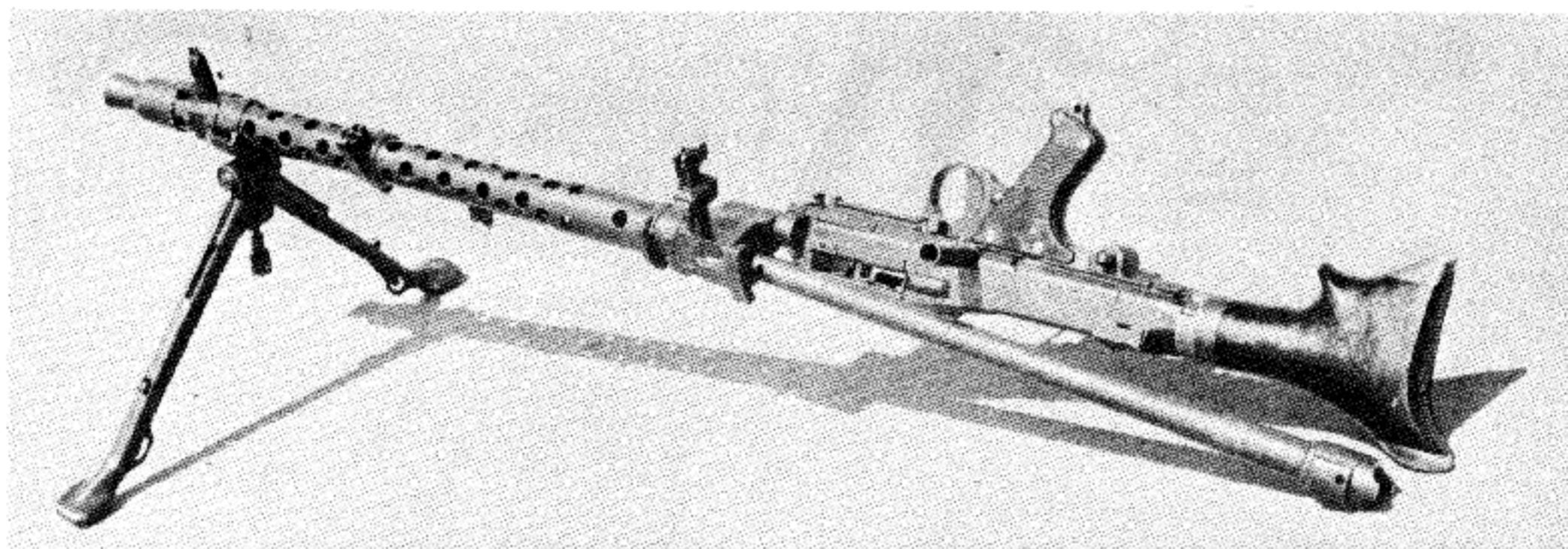

A spring catch will be found on the left side of the gun just below and to the rear of the rear sight. This is a body locking catch. Push this in with the left thumb, and with the right hand twist the frame, or body, with an anti-clockwise twist—that is twisting it from left to right—through about 180°. The body or receiver group is pivoted on a pin at the upper right of the barrel casing; thus when it is unlocked, the receiver

can be swung around on this pivot. If the muzzle of the gun is now lifted, the barrel will slide out of the barrel casing by its own weight.

Insert fresh barrel. Level the gun and push the barrel home as far as it will go in the casing. Then turn the receiver group down clockwise, from right to left, and the catch will spring into engagement, locking the gun ready for instant action.



# GERMAN 7.92 34 LIGHT MACHINE GUN

**Order of Stripping:** Push the spring catch at the extreme rear of the cover on top of the receiver and lift the cover to a vertical position.

Push the cover hinge pin from the right and lift out the cover. The feed block may be lifted off.

The butt catch is on the underside of the receiver a few inches behind the pistol grip. Press this up with the left thumb. With the right hand, turn the butt a quarter-turn left or right. (Note: The bolt should be in forward position when this stripping motion is being done. Otherwise, the very powerful recoil spring cannot be controlled.) The recoil spring will now force the butt out of the receiver. Now remove the recoil spring.

Pull the cocking handle back with a quick motion. (A jerking motion is required here because the action in releasing the bolt, twists the barrel extension and the barrel. Watch that the bolt and its carrier do not fly out the back of the receiver.) Bolt and carrier may now be removed.

Pressing the locking catch on left of receiver, below and behind rear sight, twist receiver from left to right, until it clears the barrel casing. Raise the muzzle and slide the barrel out of the casing. A hinge pin catch will be found on the underside of the barrel casing, near its end and to the right. Press this up and while maintaining pressure, twist the receiver, left to right until it has completed its full half turn. It may now be pulled out to the rear.

A catch will be found in front of the foresight.

Lifting this permits you to unscrew the flash hider over the muzzle. Inside it is a mouthpiece and a recoil cone. Remove them.

The trigger assembly is locked to the receiver by two automatic locking pins. Pinching the split ends together permits them to be pulled out. (Removal of this assembly is not recommended without suitable tools.)

**Notes on Assembling:** Be sure that the barrel is full home in the casing before twisting the receiver back into locking line.

Check that the bolt rollers line up with the lugs on the bolt carrier and that ejector is forward before inserting in the receiver. The ejector in this gun runs through the bolt at an angle from the bolt face to just above the right hand pair of rollers.

Pressing the trigger permits the bolt and carrier to be eased forward in preparation for inserting butt group.

**Further Stripping:** Bolt may be removed from bolt carrier as follows: Twist it so it slides inside the carrier and so the trigger lever is pulled and the firing pin spring released from tension. This lever is behind the right hand pair of rollers on the bolt. Pull back on the cocking piece and unscrew it from the firing pin. The bolt and its carrier can now be separated.

Should it be necessary to remove the buffer, press the buffer catch on the lower side of the butt and then twist the buffer group a quarter turn right or left.

## HOW THE GUN WORKS

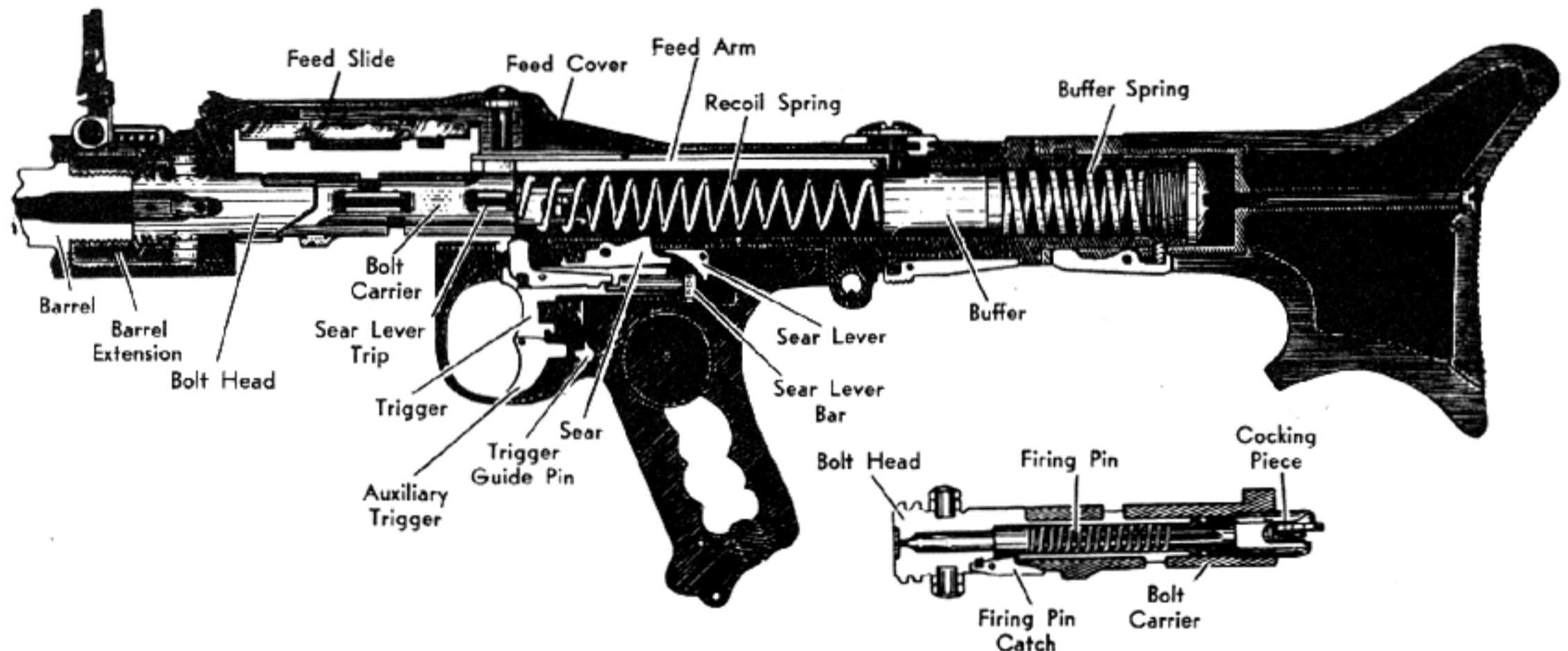

Starting with the gun loaded and cocked, the action is as follows: Pressing the trigger pulls the sear out of its bent in the breech block and allows it to go forward under the thrust of the compressed recoil spring located in the butt.

A feed piece on the top of the breech block strikes the base of the cartridge in line and pushes it from the belt towards the firing chamber. The feed arm is hollow and is operated by a stud on the top rear end

of the breech block carrier, which rides in this hollow groove and causes the feed pawl to push the next cartridge in the direction of the firing chamber.

As the breech lock continues forward, two inner rollers on its head strike two cams on a cam sleeve and rotate the head of the breech block from left to right so that threads on the breech block lock engage threads on the cam sleeve; this effectively locks the breech block to the barrel.



# GERMAN 7.92 34 LIGHT MACHINE GUN

As the cartridge chambers, the extractor in the bolt face slips over the cannelure of the cartridge. Meanwhile the breech block carrier continues forward, tripping the firing pin lever and allowing the firing pin to go forward through the face of the bolt to strike the primer. The forward movement of the bolt is stopped when a shoulder on its right frontside, strikes the cocking handle stop which is in its forward position at the end of its slot. Just before the cartridge is fired, a locking catch on the breech block engages behind the outer roller on the right side of the head of the breech block.

**Return Movement of the Action:** This gun is fitted at the muzzle with a recoil increaser somewhat resembling that operating on the Vickers gun.

As the bullet leaves the barrel, part of the gas pressure behind it expands in the muzzle attachment and rebounds against the cone to give additional backward thrust to the barrel. This action, together with the rearward thrust of the gas in the firing chamber against the head of the empty cartridge case, which transmits it to the bolt, starts the action to the rear.

Barrel and breech block start back, firmly locked together during the period of high pressure. After a backward travel of about  $3/16$ " the outer rollers on the breech block head again engage with the two cam-faces in the forward end of the receiver, thus forcing the breech block head to rotate from right to left, thereby unlocking the breech block from the barrel.

The rearward motion of the barrel is stopped, as soon as the unlocking operation is completed, when its cam sleeve strikes against shoulders in the front end of the receiver.

The stud riding straight to the rear on the breech block carrier, its head caught in the groove in the feed arm above it, twists the feed arm which forces the feed pawl slide to move back and permits the feed pawl to lock behind the next cartridge in the belt.

The empty case being drawn from the firing chamber by the extractor in the face of the bolt, is struck by the ejector and hurled out of the gun. The ejector is a pin in the top of the breech block; during the backward movement of the breech block the rear end of this pin strikes against a stop which forces the front end through its hole in the breech block to hit the base of the empty cartridge case. The ejection is downward. The end of the breech block carrier strikes against the buffer, the compression of the recoil spring is completed, and if the semiautomatic portion of the trigger is being pulled, the bolt will stop open, engaged from below by the sear forced up by its spring. If the automatic trigger is being pressed, the firing cycle will be completed and continued as long as there are any cartridges left in the belt.

Six modifications of the L. M. G. 34 are known. Differences are slight, however. Some models may have only a full automatic trigger and a push through safety.



# GERMAN MAXIM 7.92-MM 08-15 LIGHT MACHINE GUN

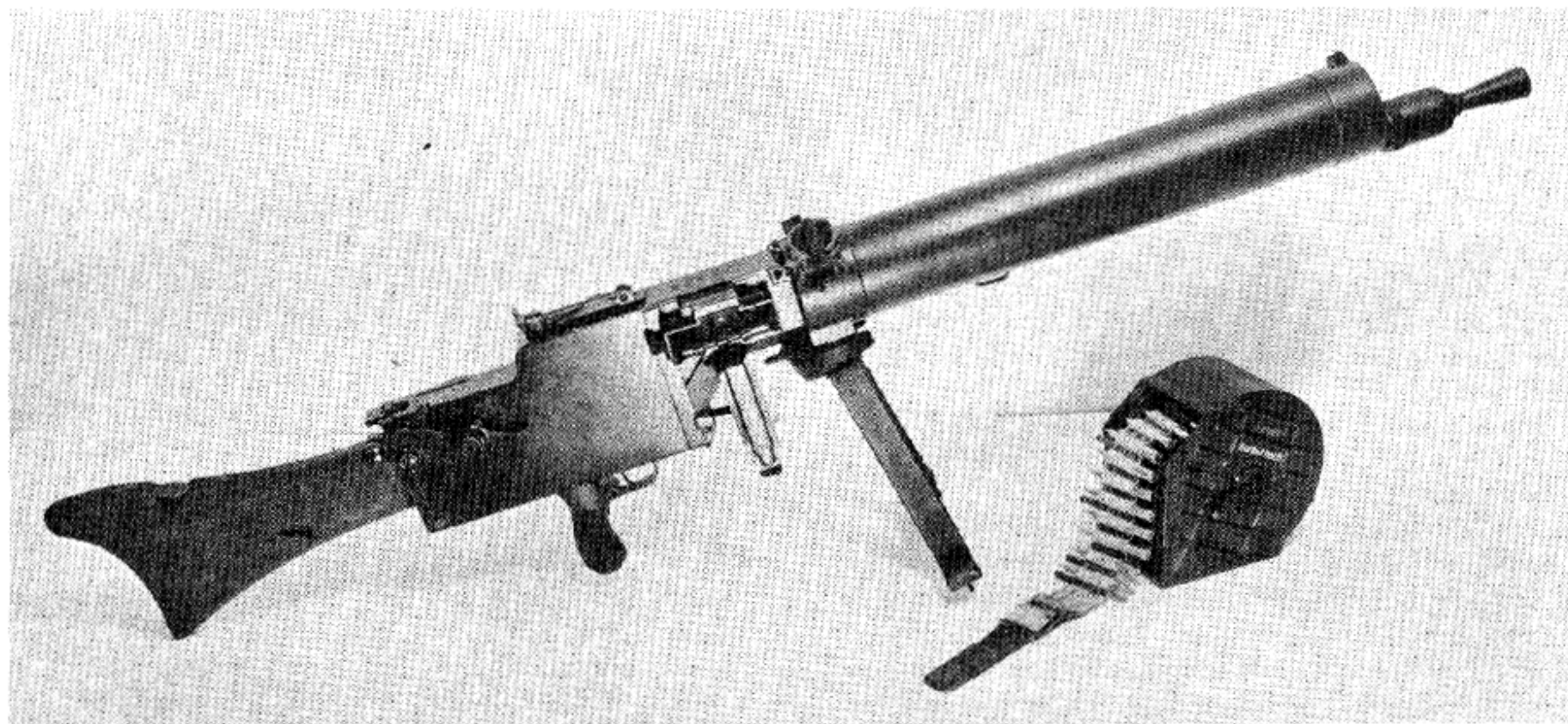

The operating principles of this weapon are essentially the same as those of the other Maxim types. It was designed to provide greater mobility and to be handled by one man if necessary. It too is a second line weapon with the German Army today. However, the gun and detailed hand books were being distributed by the German Army as late as 1936. This is evidence of the value the Germans still attach to these weapons.

**Caliber:** 7.92mm German Service cartridge.

**Type of Feed:** Belt feed from a box when used by a gun crew. Belts unreeled from a steel drum when used by an individual.

**Length of Barrel:** 28 $\frac{1}{4}$ ".

**Weight of Gun:** 31 lbs. when adapted for tripod; 30 lbs. if adapted by bipod rest.

**Mounting:** Tripod weighing fifty-one lbs.; or bipod weighing 2 $\frac{1}{2}$  lbs.

**Gun Operated by:** Recoil. Maxim principle.

**Locked:** Toggle joint Maxim principle.

**Cooled:** Water. Water jacket around barrel.

**Cyclic Rate of Fire:** 500 a minute.

**Sights:** Barleycorn front and open V rear, adjustable to 2000 meters.

**Type of Fire:** Full automatic only.

**Position of Crank Handle:** Right side, pushed forward to load the gun.

## LOADING AND FIRING

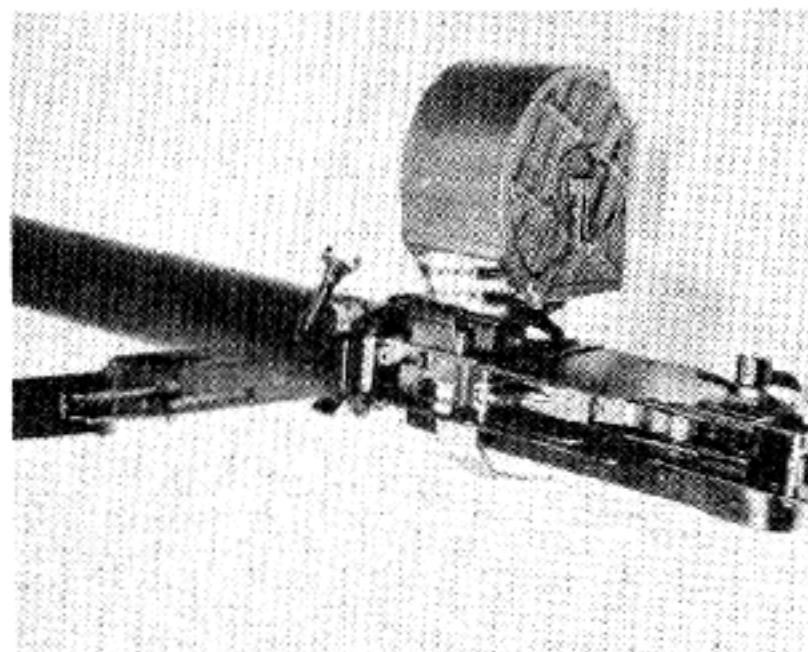

1. **Loading:** If belt is used from box, load exactly as for heavy Maxim. If drum is used, the cartridge belt is wound around the wheel which revolves within the drum. An indicator on the outside shows the number of cartridges remaining. Slide this drum into its locking slot (directly below the feed block on the right hand side of the gun). A catch at the forward end of the feed block will lock it securely.

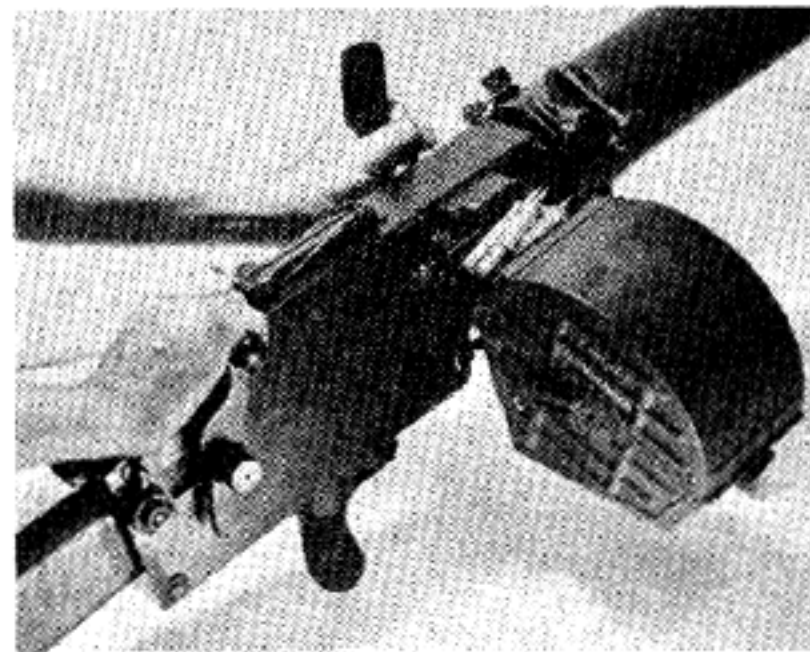

2. Now proceed exactly as for heavy Maxim. First pull the belt through with a slight draw to the front. Then while retaining a firm hold push the crank handle forward as far as it will go and holding it in that position, pull the belt through. Release the crank handle and let it slide back under the influence of the spring. Now roll the crank handle forward a second time, pull the belt through again, and release the crank handle to fly back for the second trip.

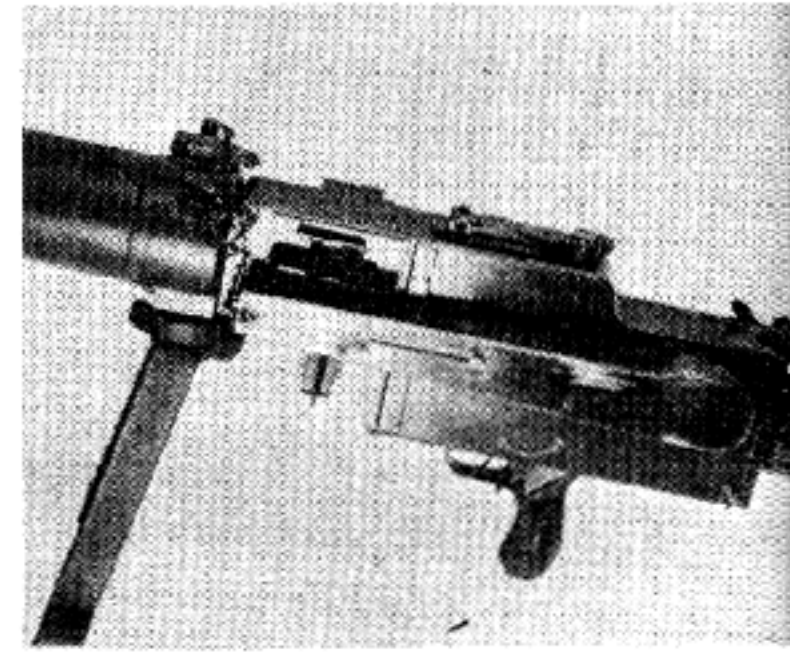

**To fire**—This weapon is fitted with a rifle type butt. It is intended to be held against the shoulder. It also has a pistol grip and standard type trigger and trigger guard, below the receiver. On the left side of the receiver above this pistol grip will be found the safety lever. Pushed forward to the letter "S" it is safe and the gun cannot be fired. Drawn down to the rear to "F" it is in firing position. When the gun is loaded, and the selector set at "fire" pressing the trigger will fire the gun. Operation will continue as long as there are any cartridges being fed into it.



# GERMAN MAXIM 7.92-MM 08-15 LIGHT MACHINE GUN

## FIELD STRIPPING

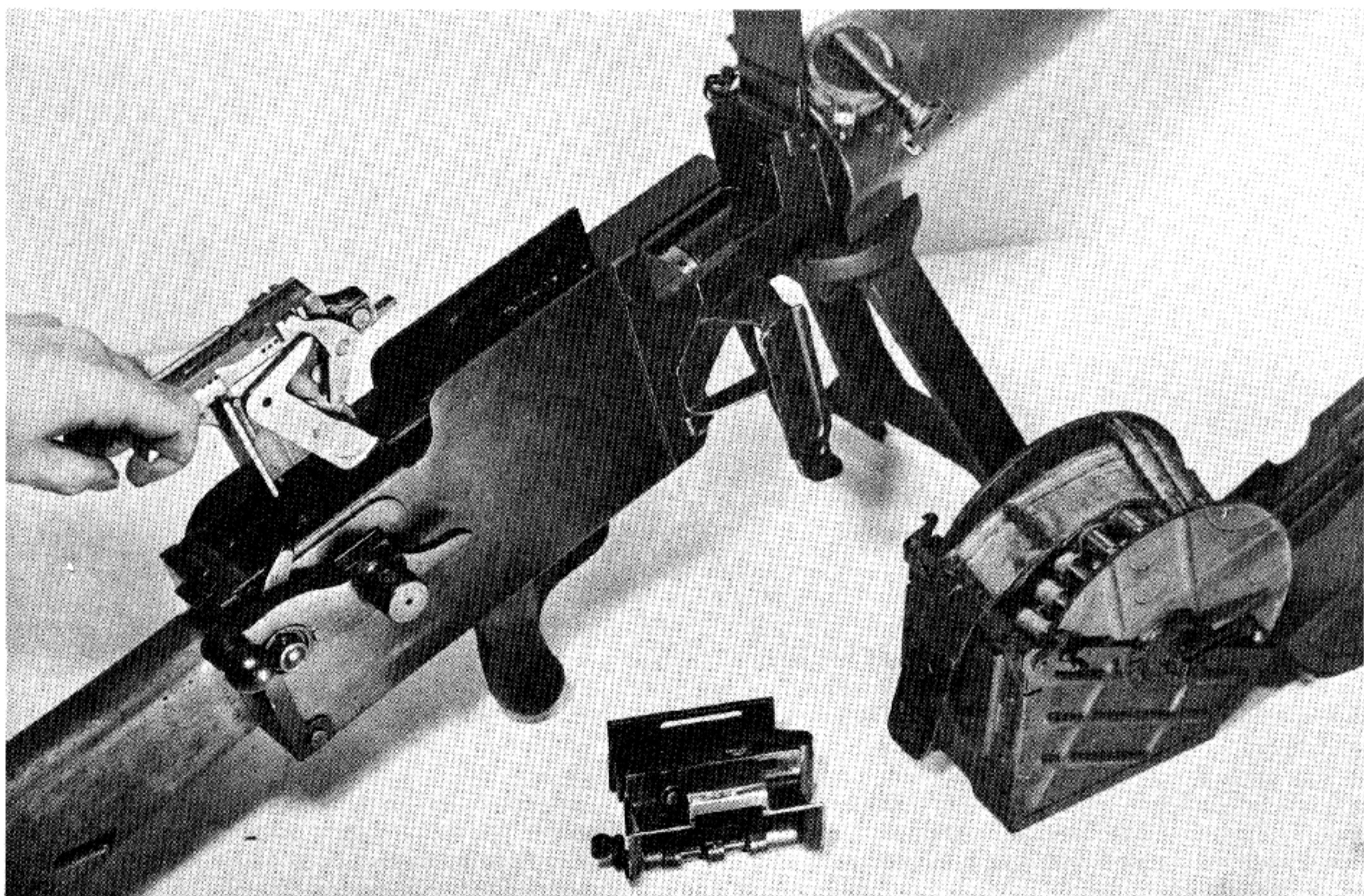

Dismounting this weapon is essentially the same as dismounting other Maxims. The cover is raised by pushing up on the spring cover latch at the rear of the gun where the butt joins the frame. The cover is lifted, the feed block lifted directly out of its seating, the crank handle pushed forward and held there while the lock is lifted out. The lock is then twisted on the stem connecting it to the connecting rod. The lock is then lifted out. Spring box on the left side of gun is sprung forward, down and off as in the case of other Maxims. Locking pin passing through gun above crank handle is released from the left side and pushed through to the right after which the butt may be dropped down out of line with the barrel extension. Side plates, barrel extension and barrel may then be withdrawn directly

to the rear.

**Note:** On Maxim Guns, there is an indicator on the fusee spring box indicating the weight of the spring.

The bipod mount is so arranged that it can be fastened near the muzzle or just ahead of the feed box below the gun.

Another model of the Maxim known as the Light Machine Gun 08-18 also is manufactured in large quantities in Germany. This gun is practically identical with the model 08-15 except that it has no water jacket; instead is fitted with a heavy barrel and an outer barrel casing. It is air cooled. A carrying handle for the barrel is provided on the barrel just forward of the feed block.



# GERMAN MAXIM 7.92-MM 08 MACHINE GUN

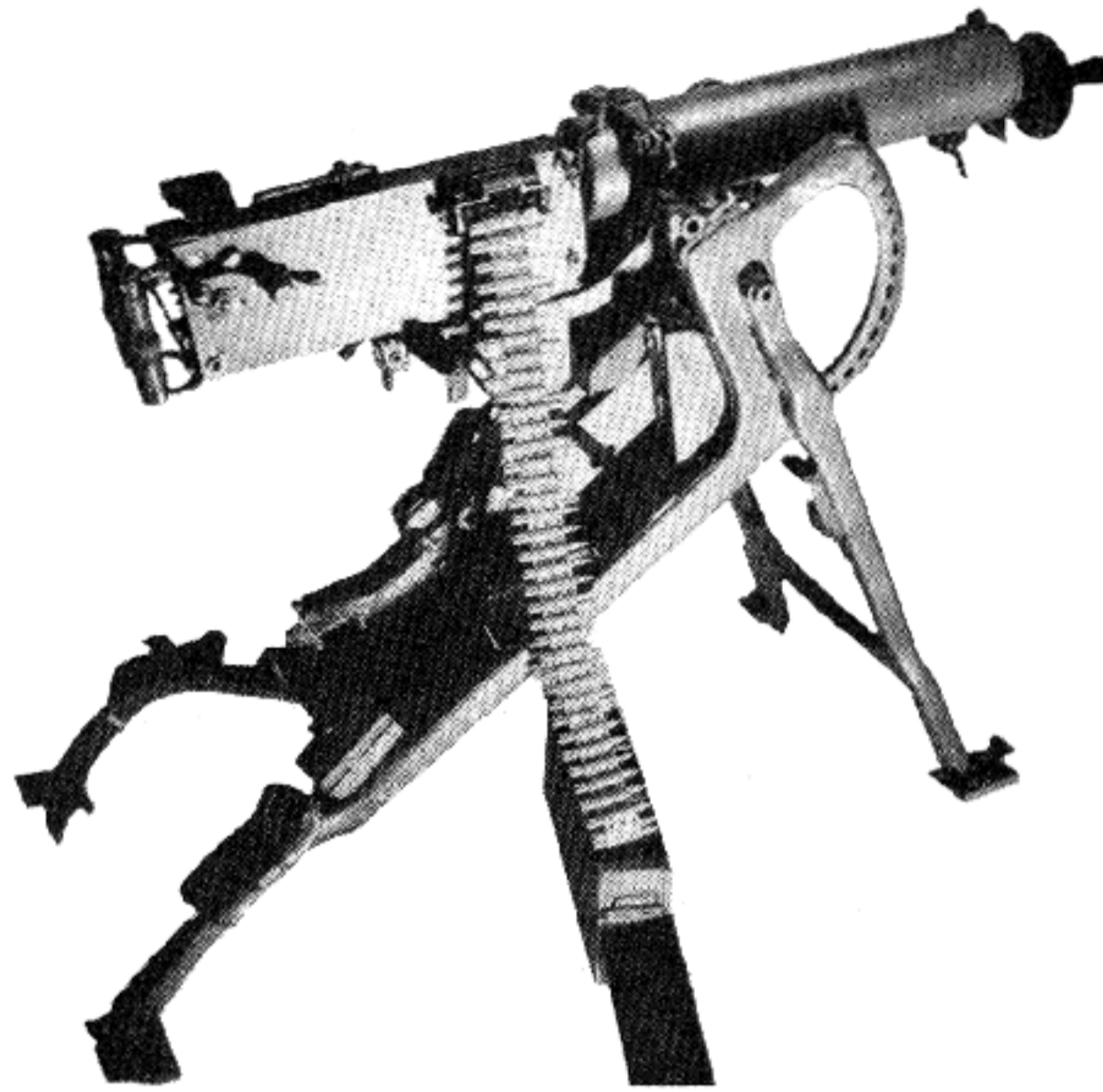

This is the so-called Medium Machine Gun. It is no longer used in the German first line armies. It has been supplanted by the M. G. 34 and M. G. 42. However, it is an excellent type of heavy machine gun, and tremendous quantities are known to exist and be in use for Home Guard and fortress defense in Germany. The Russians use a Maxim of this type very widely.

**Caliber:** 7.92mm German Service cartridge.

**Type of Feed:** Fabric belt with brass eyelets as in the case of the British Vickers.

**Capacity of Belt:** 100 and 250-rounds.

**Ballistic Data:** Standard for this cartridge.

**Barrel Length:** 28 $\frac{1}{4}$ ".

**Weight of Gun:** 40 $\frac{1}{2}$  lbs.

**Mounting:** Tripod type, weighing 65 $\frac{1}{2}$  lbs. and sleigh type weighing 83 lbs.

**Accurate Range:** About 600 yards. So called "effective range" with telescopic sight about 3800 yards and maximum range about 5000 yards.

**Gun Operated By:** Recoil of weapon aided by rebounding gas from muzzle attachment as in Vickers. This is the basic Maxim principle.

**Locked:** By toggle joint on general principle employed in Vickers. Barrel and locking mechanism recoil together for a short distance, barrel then halts while lock continues to rear.

**Cooled:** Water. Water jacket surrounds barrel.

**Cyclic Rate of Fire:** About 500 a minute.

**Type of Fire:** Full automatic only. Single shot fire can be obtained if trigger can be released quickly enough; otherwise it can be obtained only by method of loading the belt.

**Safety:** Safety on thumb trigger must be pushed to the right before trigger will go in. Automatic safeties customary to machine guns to prevent cartridge from being fired until action is completely locked, are also incorporated in the mechanism.

## LOADING AND FIRING

1. The tag end of the loaded belt is fed through the breech block from the right hand side and given a sharp pull through and somewhat ahead. Then holding the pressure on the tag, push the crank handle forward as far as it will go. Note that the crank handle is pushed forward, not pulled back as in the Vickers.

2. Now with the left hand pull the cartridge belt through again. Release crank handle and let it fly back.

3. Pull with the left hand, roll the crank handle forward as far as it will go for a second time. Pull belt through again. Release crank handle again.

4. **To Fire:** In the center of the split thumb-trigger, is a small lever. While grasping the traversing handles when ready to fire, the left thumb must push this safety over towards the center, to permit the thumb trigger to be pushed in with both thumbs. When the thumb is removed from the safety, the weapon stops firing.

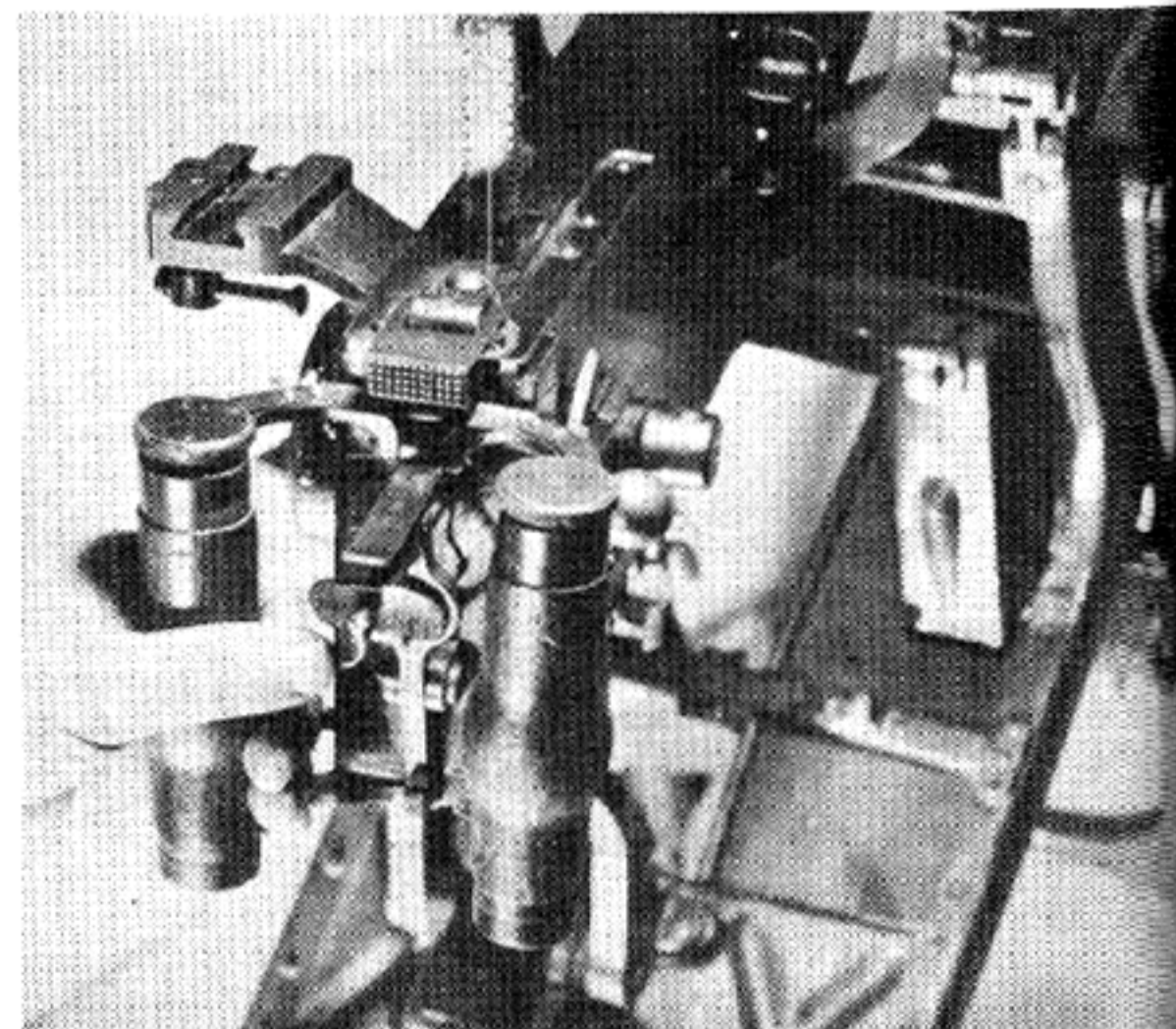



# GERMAN MAXIM 7.92-MM 08 MACHINE GUN

## NOTES ON FIELD STRIPPING

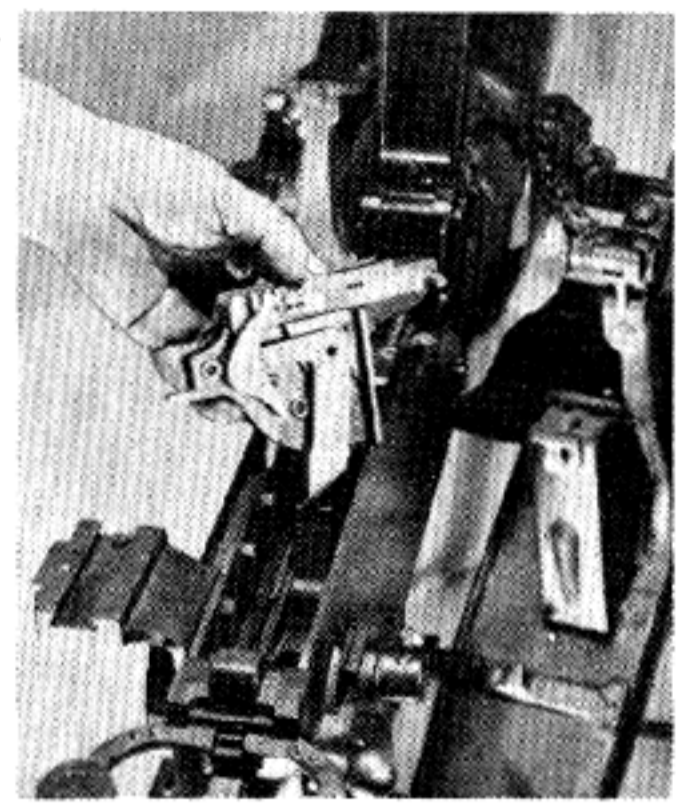
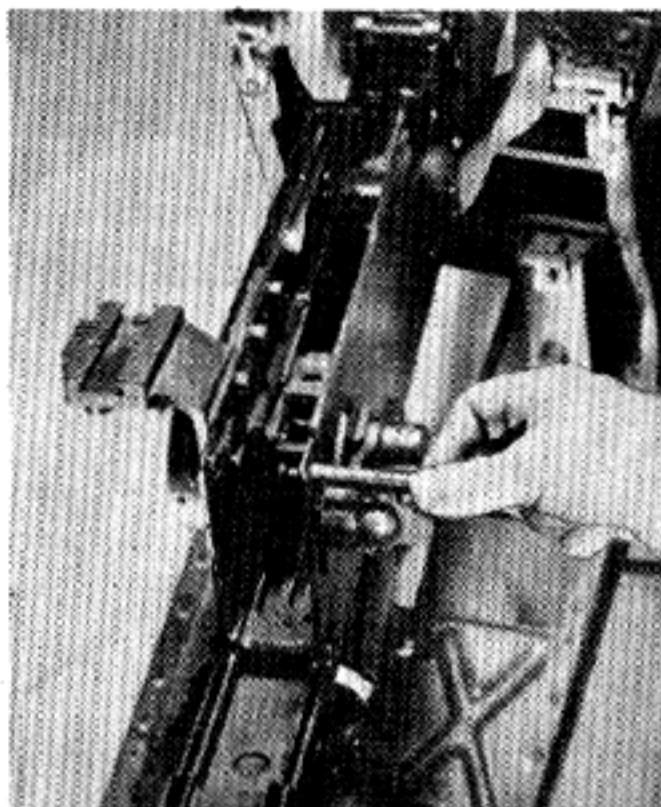
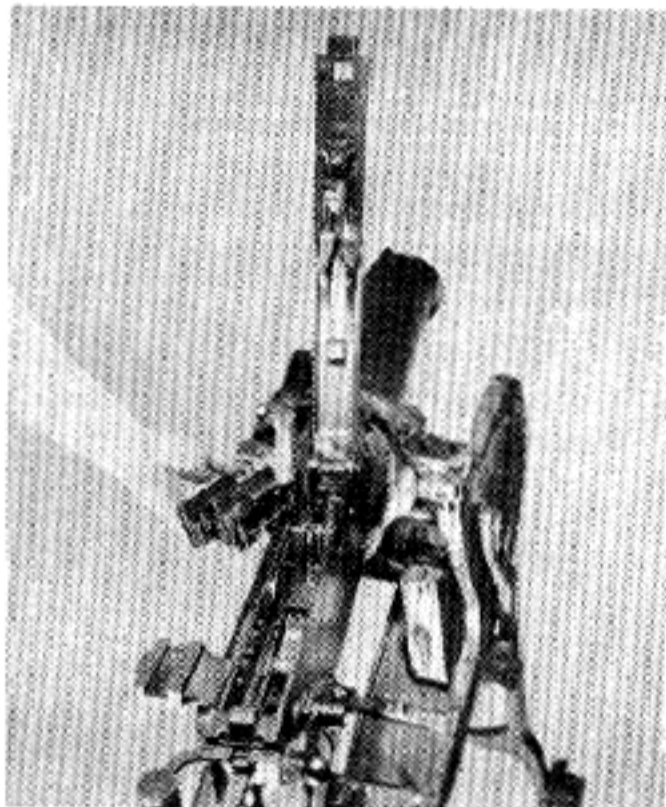
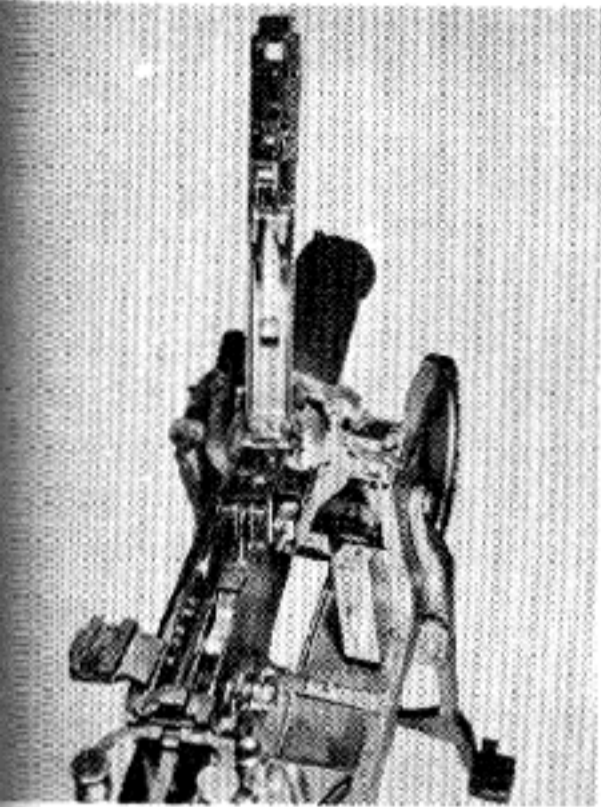

1. The top cover catch is located at the end of the cover just over the traversing handle. Push this up against this spring and raise the cover as far as it will go.
2. The feed block, positioned just behind the hinge of the top cover may now be grasped by the hands on either side and lifted straight up and out of its place in the receiver. (Note that the cover on the Maxim extends the full length of the receiver.)
3. Push forward the crank handle with the right hand and reaching inside with the left hand grasp the lock firmly, pull it straight up out of the receiver. Then

twist the lock on its stem on the connecting rod, which will free it and permit it to be lifted off the connecting rod. **Note:** This lock resembles the Vickers lock but is much more massive and rather more complicated. However, the stripping sequence is close enough to the Vickers so familiarity with one will enable you to dismount the other.

4. Press the locking spring on the pin which passes through the gun directly above the crank handle at the rear of the gun. The spring pin is located on the left side of the gun. Push it through and remove the pin from the right. The travers-

ing handles may now be pulled down to the horizontal position.

5. Spring box and fusee pin are removed as for the Vickers.

6. Side plate, barrel and barrel extension may now be pulled directly to the rear as in the Vickers. This completes field dismounting.

**NOTE:** Unlike the Vickers it is not necessary to remove the muzzle attachment in order to pull the barrel out of this gun. In the Vickers the barrel cap is screwed onto the barrel itself. In the Maxim it is screwed onto the water jacket.



# HUNGARIAN FROMMER 7.65-MM AUTOMATIC

(In general use in Austria)



This is a Hungarian weapon very widely used in the Balkans. The design is simple and very efficient, but the cartridge is of the type considered a pocket pistol cartridge in the United States. It uses the Standard United States, .32 caliber Automatic Colt Pistol cartridge.

**Details:** This pistol has a grip safety as in the Colt .45 Automatic. When the pistol is gripped firmly the weapon may be fired. It also has an external hammer which may be lowered to half cock. Grasping milled sur-

faces on head of bolt just in front of hammer permits bolt to be drawn back against the tension of the main spring. Releasing the bolt loads the firing chamber and leaves the pistol ready for firing. Magazine capacity is 7 cartridges. Muzzle velocity about 980 feet per second. Muzzle striking energy: 152 pounds.

While this is a well-designed and beautifully made weapon, it does not qualify as a military pistol in the accepted sense of the term. However, it is esteemed by Austrian officers.

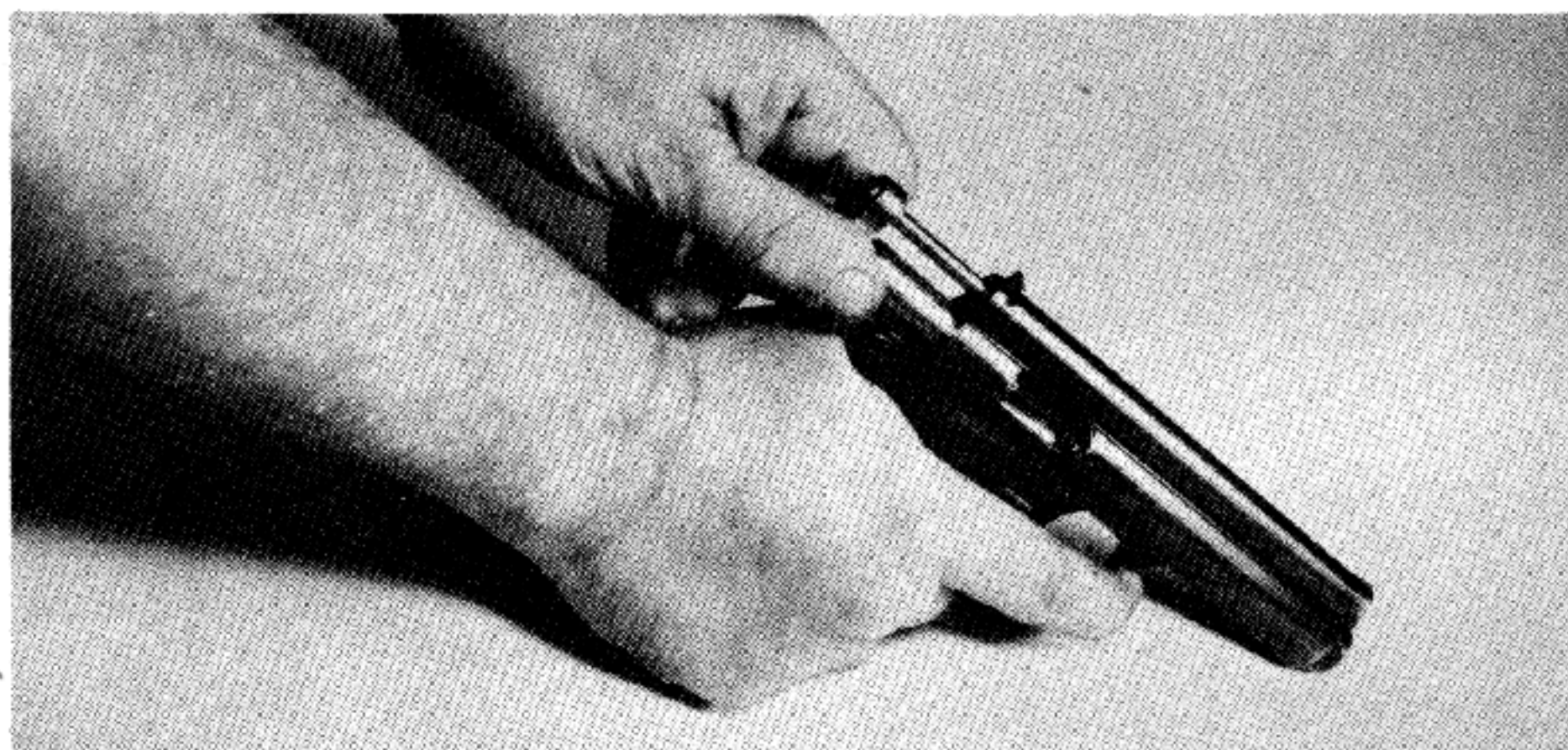



# ITALIAN BERETTA 9-MM SUBMACHINE GUN



**Note:** This is the finest and most important Italian sub-machine gun.

**Caliber:** 9mm Parabellum type cartridge.

**Note on Ammunition:** This weapon uses the Parabellum type cartridge with a flat, truncated-cone like bullet. This cartridge is generally used in Glisenti automatic pistols. However, the weapon is well and strongly made and will withstand the additional power of standard German-type Parabellum ammunition.

**Ballistic Data:** 9mm cartridges, Parabellum type, of Italian manufacture seldom develop over 960 feet per second velocity. This establishes the general relationship between the Italian and the German manufactured ammunition.

**Magazine:** Straight box type: 10-20-40 round capacity.

**Position of Magazine:** Directly under receiver. Magazine catch on under side of weapon.

**Weight:** 10.3 pounds with loaded 40 round magazine.

**Accurate Range:** About 300 yards.

**Sights:** Fixed front, open rear elevating in 100 meter stages from 100 to 500 meters.

**Operation, Locking and Cooling Data:** Same as for Solothurn.

**Cyclic Rate of Fire:** 400 to 500 rounds per minute, depending largely on type of ammunition used.

**Compensator:** Like the Solothurn, this weapon has a built-in compensator which permits escaped gases to rise freely **up** and straight ahead and forced **down** on the shelf on the bottom of the compensator, thus tending to hold the weapon down and forward against the thrust and rise of the recoil.

**Note:** This weapon is issued with a folding bayonet. The blade folds and locks back on the under side of the barrel casing.

**Position of Cocking Handle:** A knob on the right side of the receiver.

**Type of fire:** Single shot or full automatic. Weapon has **two separate triggers**. Pressing the **forward trigger** fires a single shot. Pressing the **rear trigger** fires full automatic as long as pressure is maintained.

1. Insert a loaded magazine from the underside, push in as far as it will go.

2. Pull back cocking handle to cock bolt; and then push the handle forward as **far** as it will go, or the bolt will have to carry it forward in its motion, giving a weak striking action which will cause a misfire or jam.

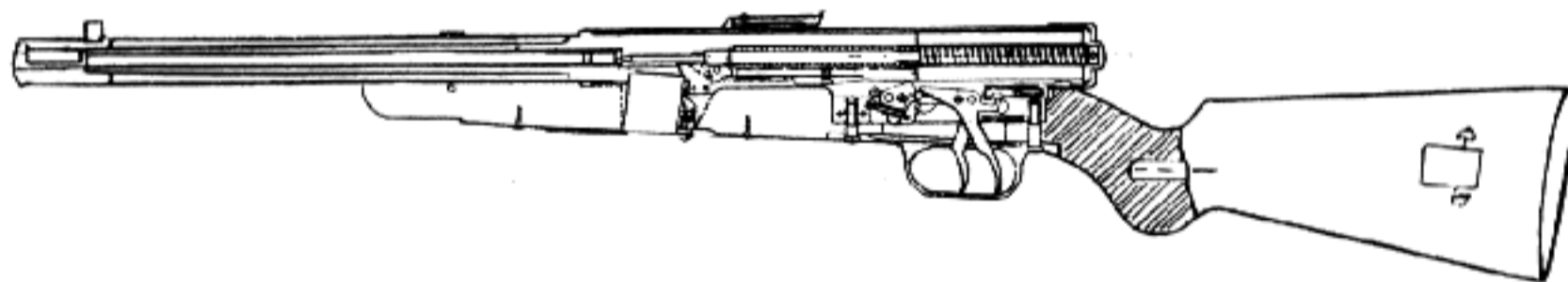

sezionale

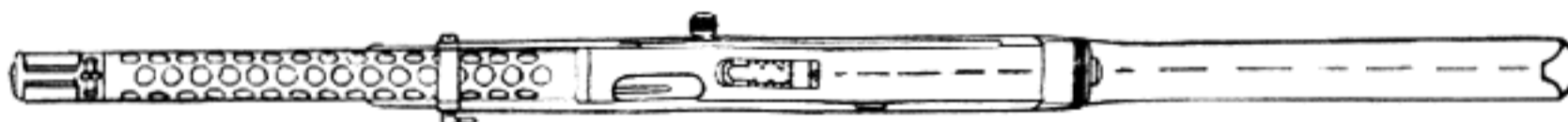

visto dell'alto



# ITALIAN BERETTA 9-MM 1934 AUTOMATIC

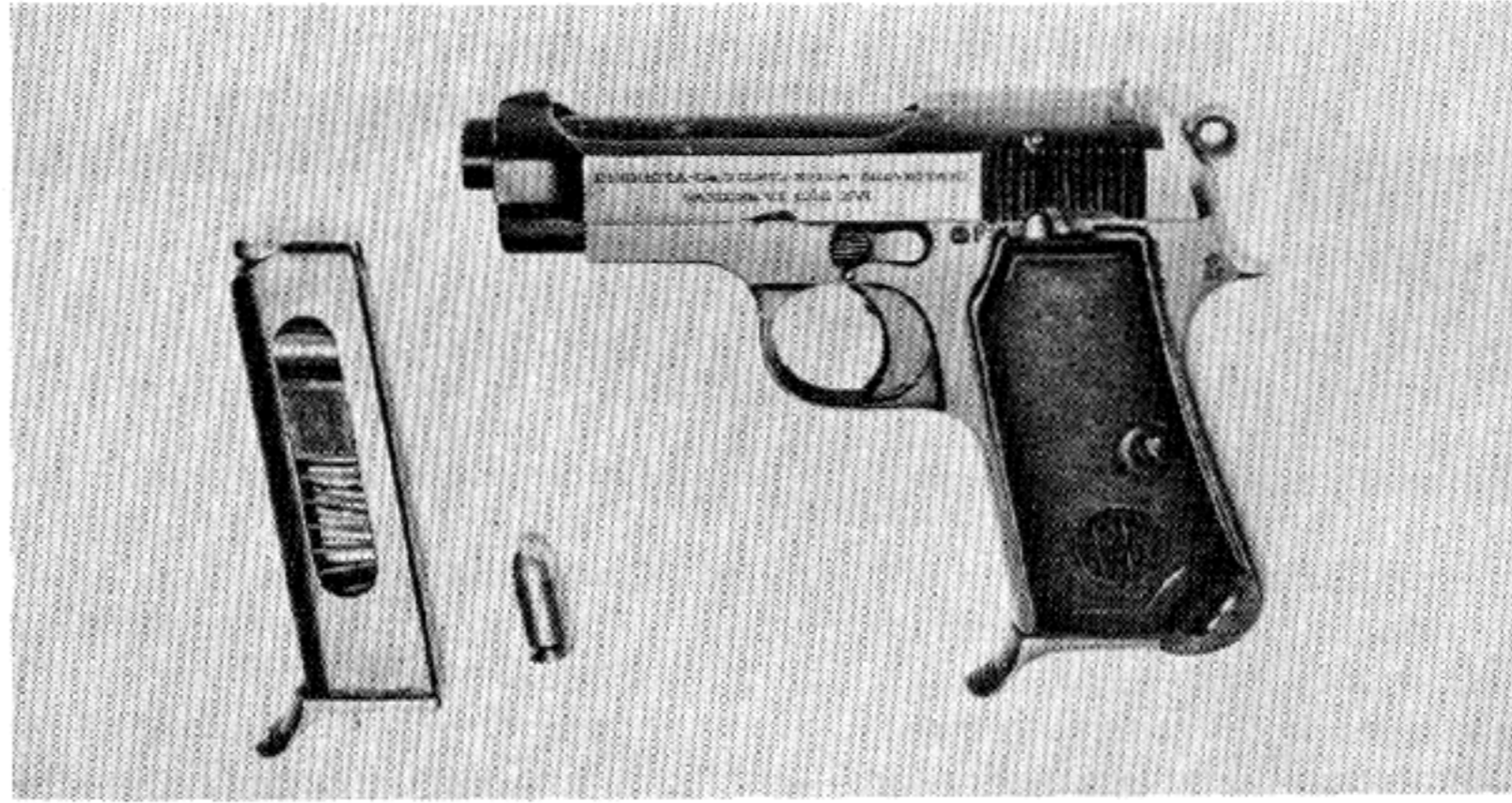

**Caliber:** 9mm Corto (Identical with .380 Colt Automatic Pistol cartridge)

**Magazine:** Box type, single line, Capacity 7 cartridges.

**Muzzle Velocity:** 970 feet per second.

**Weight of Bullet:** 95 grains, lead with full metal jackets.

**Muzzle Striking Energy:** About 195 foot pounds.

**Barrel Length:** 3 1/2".

**Overall Length of Pistol:** 6".

**Weight of Pistol:** 23 1/2 ozs.

**Sights:** Fixed, front sight machined into slide.

**Accurate Range:** 25 yards.

**Maximum Range:** About 800 yards.

**Pistol Operated By:** Recoil.

**Locked:** Blowback type, unlocked. This is a low power cartridge, and heavy recoil spring and slide keep the breech closed until bullet has left barrel.

**Type of Fire:** Single shots only.

**Magazine Release Catch:** Thumb piece on lower rear of handle. Must be pushed back to release magazine.

**Position of Slide When Last Shot is Fired:** Open. Note: This is a tricky arrangement. When magazine is extracted, slide moves forward immediately. Thus this feature is intended merely to advise you that the pistol is empty; and is not to be used as a reloading help



as in the Colt and Luger hold-open devices.  
**Safety:** Directly above the trigger on the left side of the pistol. When catch is pushed down and to the rear, it covers a small red ball and the letter "F." It is now safe. The letter "S" is exposed.

**Note:** Earlier models of the Beretta pistol used the 9mm Glisenti cartridge which is more powerful than the 9mm Corto. These models have an additional heavy recoil spring in the handle to act as a buffer. They are not particularly reliable weapons, and can be dangerous if used with high power German ammunition.

## INSTRUCTIONS FOR LOADING AND FIRING

1. Load Magazine exactly as for Colt Automatic Pistol. Insert in handle and push in until its locks.

2. Draw back slide exactly as for Colt Automatic. Release slide and let it drive forward pushing cartridge into firing chamber and closing pistol.

3. Push safety catch around into locking position unless weapon is to be fired.

(Note: The exposed hammer may be let down gently on the firing pin if care is taken and the operation is done with both hands. It may also be set at half-cock).

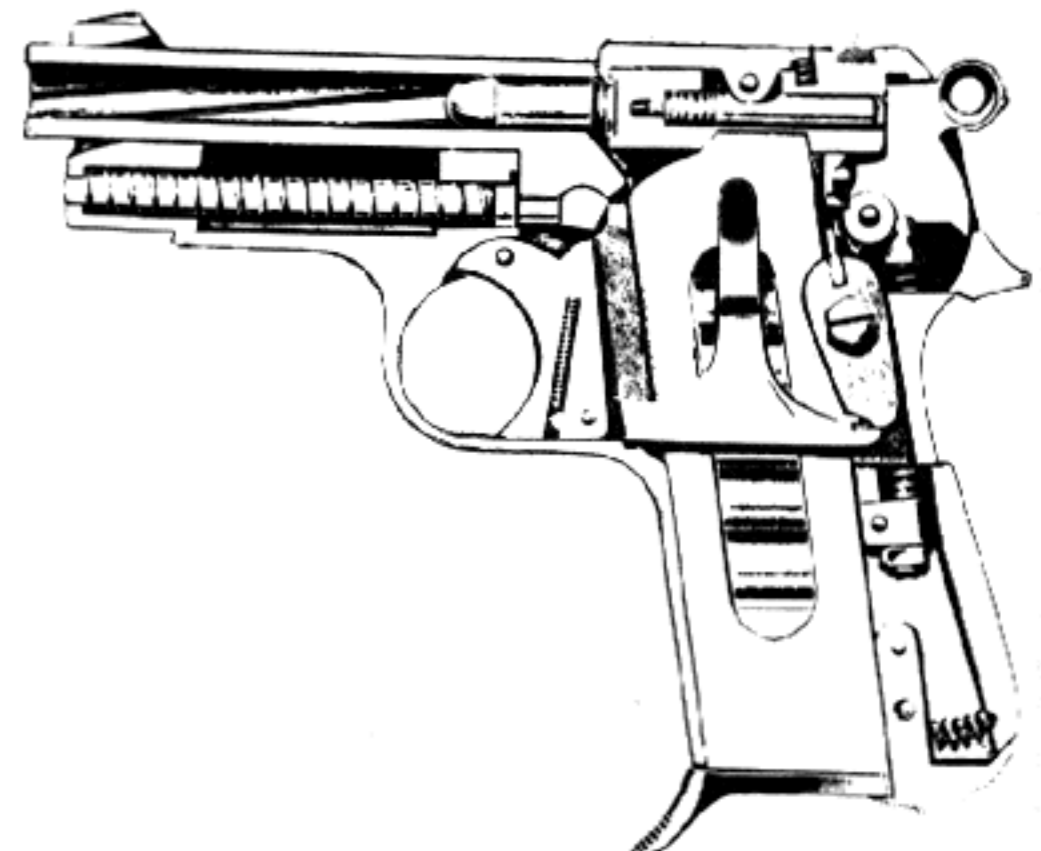



# ITALIAN BERETTA 9-MM 1934 AUTOMATIC

## FIELD STRIPPING



1. With magazine out of weapon, pull back slide as far as it will go; hold it with right hand and with left thumb push safety catch up into locking notch in under side of slide.



2. Now push **straight back** on barrel with palm of hand. This will free barrel from its locking recess.

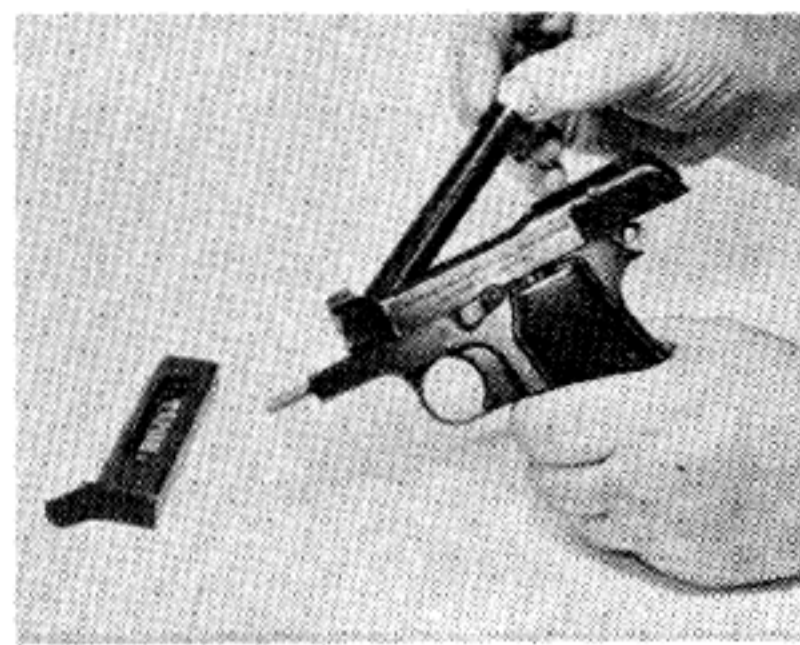

3. Pull barrel straight back and up, drawing it out of the slide as shown.



4. Push slide, recoil spring and recoil spring guide straight forward off the receiver. Spring and guide may now be removed from their seats. Safety locking stud may also be lifted out now. No further dismounting is necessary with this pistol.



# ITALIAN GLISENTI 9-MM 1910 AUTOMATIC

(This is the Standard Italian Pistol)

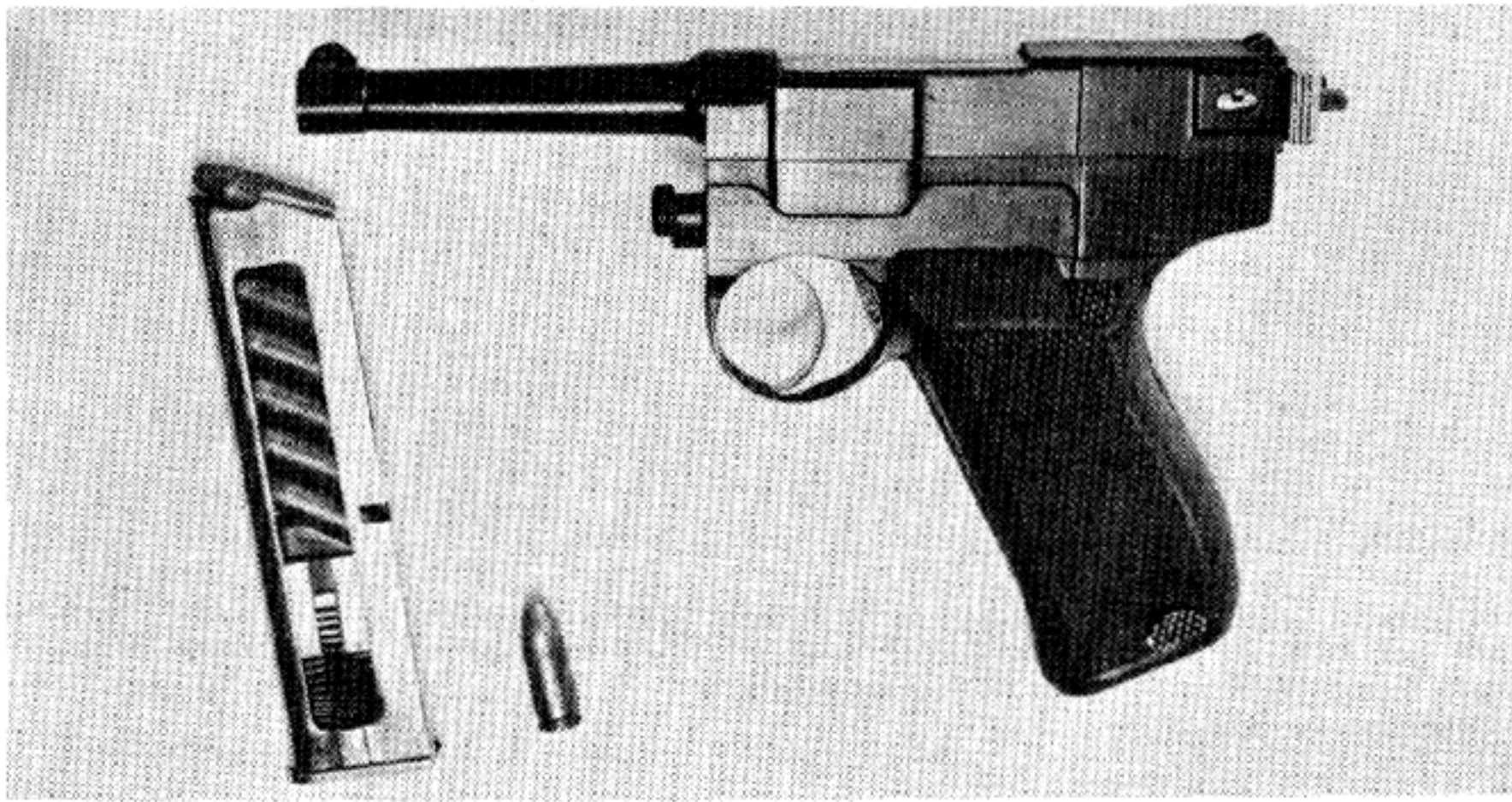

**Caliber:** 9mm, Parabellum type.  
**Magazine:** Box type, single line, capacity 7 cartridges.  
**Muzzle Velocity:** About 960 feet per second.  
**Weight of Bullet:** 125 grains, lead with full metal jacket, truncated cone type.  
**Muzzle Striking Energy:** About 320 pounds.  
**Barrel Length:** About 4".  
**Overall Length of Pistol:** 8 $\frac{1}{4}$ ".  
**Sights:** Luger type, fixed.  
**Accurate Range:** 75 yards.  
**Maximum Range:** About 1000 yards.  
**Pistol Operated By:** Recoil.  
**Locked:** By locking arm moving up through sleeve or barrel extension, into notch in bottom of bolt.  
**Type of Fire:** Single shot only.  
**Magazine Release Catch:** On lower left side of handle, it is a milled button which must be pressed to release the magazine.  
**Position of Bolt When Last Shot is Fired:** Full back; pistol open.  
**When a Loaded Magazine Has Been Inserted:** Pulling back slightly on the open bolt and releasing it will

reload the chamber and lock it ready for firing.

**Weight of Pistol:** 32 ozs.

**Safety:** (a) An automatic grip safety is in the front end of the grip underneath the trigger. As in the Colt Automatic, the weapon cannot be fired until the pistol is gripped firmly in the hand so that this grip safety is pushed in. (b) **Thumb Safety:** At the extreme rear end of the bolt is a flying nut which may be turned down to the left to set the pistol on **safe**. The weapon cannot be fired when safety is in this position.

**Note on Ammunition:** This pistol takes a Luger or Parabellum type cartridge. However, it is about 2/100th of an inch shorter than the standard German pistol cartridge of this type. The Glisenti will **not** handle the 9mm Corto type cartridge used in the Beretta and similar automatic pistols. The standard German ammunition is unpleasant to shoot in this pistol, while the high velocity ammunition developed for use in such weapons as the Machine Pistol 38, may be actually dangerous because of the excessive breech pressure developed.

## INSTRUCTIONS FOR LOADING AND FIRING

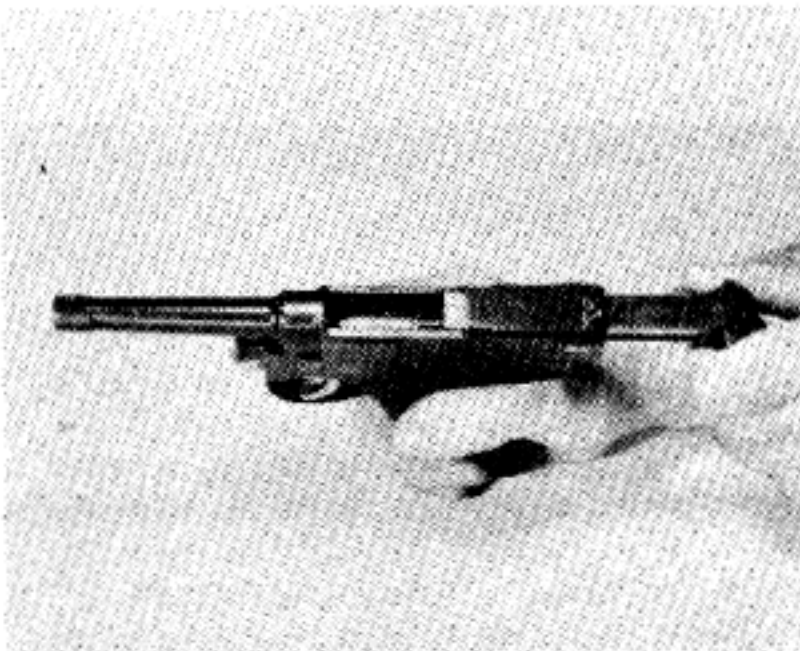

1. Insert magazine in handle and push up until it locks securely.

2. Grasp the bolt wings at the rear of the weapon firmly and pull straight back. This will cock the striker and permit the first cartridge to rise in line with the bolt. Now release the bolt to drive forward, loading the firing chamber.



3. Turn up the fly nut thumb safety as illustrated. This will securely lock the pistol against accidental charge. Note: when the striker is cocked, a circular plunger protrudes slightly between the wings of the thumb safety, showing the cocked position.



# ITALIAN GLISENTI 9-MM 1910 AUTOMATIC

## FIELD STRIPPING

1. Protruding from the front of the trigger guard is a circular milled screw. Beneath this is a pin retained by a spring. Push this pin in and while holding it in, pull the screw out slightly and twist it in locking position. This will free the side plate which may then be lifted out of the pistol.

2. Pressing in on milled button at top of left hand stock will release the stock so it may be pried loose from the pistol. This exposes most of the working mechanism.

3. Because of the variety of small springs and pins involved, further dismantling of this pistol is not recommended. For barrel cleaning, insert empty magazine in the handle and withdraw bolt. The bolt will now stay open.

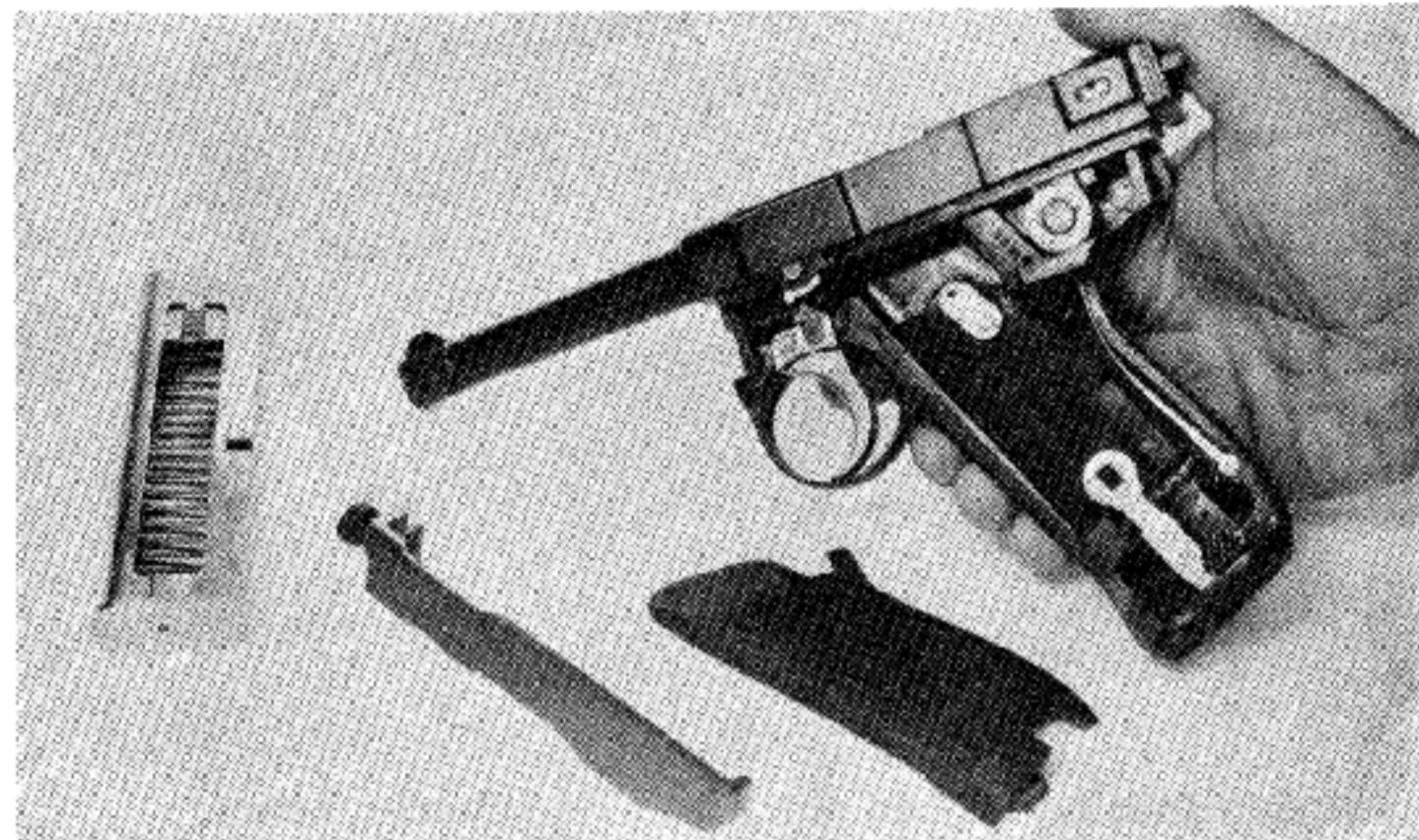

## HOW THE GLISENTI PISTOL WORKS

**Starting with the Pistol loaded and cocked, the action is as follows:** The grip safety being pressed and the trigger squeezed, the sear is permitted to revolve and the striker is released and driven forward by its spring. As the cartridge is fired, the bullet moves forward out of the barrel and the rearward pressure of the gas forces the cartridge case and the locked bolt, barrel and barrel extension directly to the rear. They travel back locked together for about  $\frac{5}{8}$ ". Here the barrel halts against the barrel stop; the locking arm moves down out of its notch in the bottom of the bolt and out of line with the barrel extension. During this action the locking arm spring is compressed; as is the combination striker and recoil spring. The extractor fitted in the head of the bolt draws with it the empty cartridge case, which strikes against the ejector and is hurled up and out of the pistol.

The magazine follower spring drives the top cartridge up in line with the bolt.

**Return Movement of the Action:** The bolt is now pulled forward by the force of the recoil spring. Nearing its forward position it picks up the top cartridge from the magazine and drives it ahead into the firing chamber. The striker lug makes contact with the sear and is held in position by it, the spring partially compressed. This action cocks the striker for the next shot. The locking arm, driven by the locking arm spring, now moves up through the sleeve into the notch in the bottom of the bolt, securely locking the bolt to the sleeve (or barrel extension). The combined pressures of the locking arm spring and the recoil spring carry the barrel and barrel extension forward for the additional distance necessary to complete the locking motion. The sear is mounted on the sleeve (barrel extension), and cannot be operated unless the action is fully forward and locked.

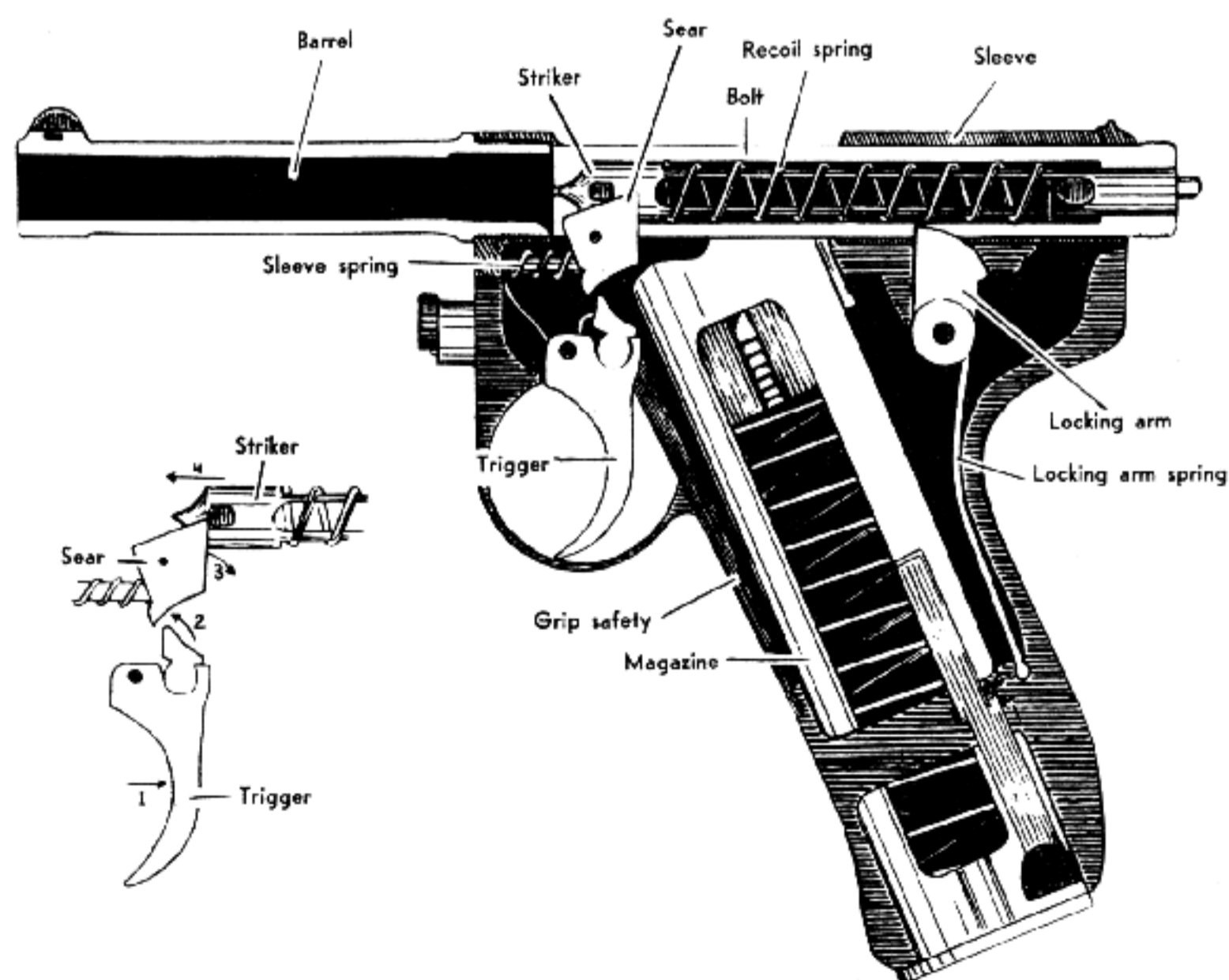



# ITALIAN REVELLI (FIAT 1914) 6.5-MM MACHINE GUN

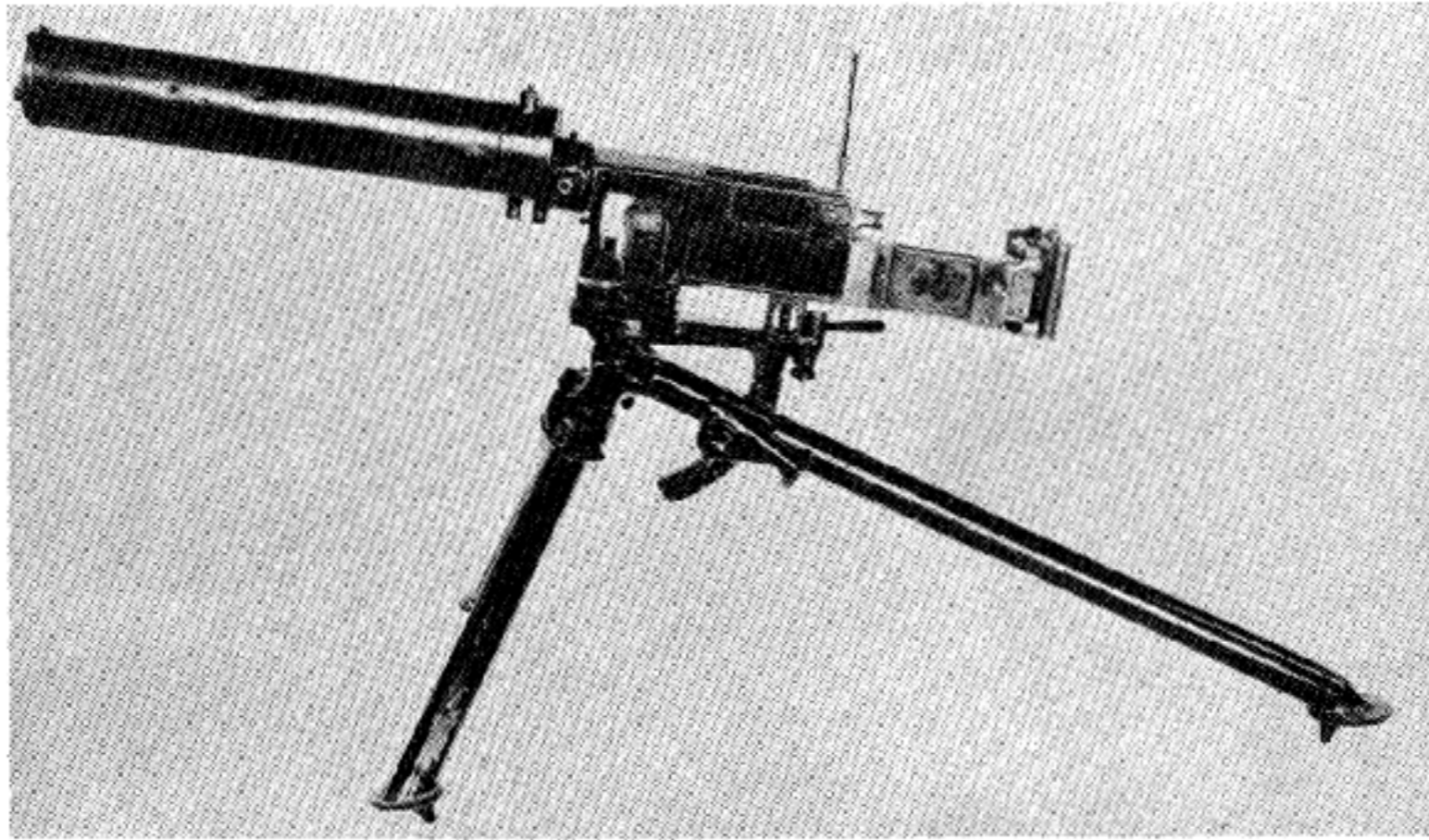

This is sometimes called the Fiat, 1914 Model after arsenal of manufacture.

**Caliber:** 6.5mm Italian service cartridge (Caliber .256-inch).

**Magazine:** Mouse trap type, holding 50 cartridges in 10 lines of 5 each.

**Muzzle Velocity:** About 2000 feet per second.

**Weight of Bullet:** 162 grains, lead with full metal jackets.

**Barrel Length:** 25 $\frac{3}{4}$ ".

**Overall Length of Gun:** About 46"

**Weight:** 37 $\frac{1}{4}$  lbs.

**Mounting:** Tripod mount is provided with this weapon. It weighs 49 $\frac{1}{2}$  lbs.

**Sights:** Barleycorn front and V type rear sight, adjustable from 200 to 2000 meters.

**Accurate Range:** About 500 yards.

**Gun Operated By:** Recoil and blowback. This is a freak design. Rearward thrust of gases in the firing chamber against the case push it back against the breech block, compelling the locking and recoiling mechanism to move backwards compressing a recoil spring and working the weapon.

**Locked:** This is not locked in the true sense of the word, but employs a so called hesitation system. During

the period of high breech pressure, opening of the breech is delayed by a rotating wedge which connects breech lock and barrel during the first stages of the movement to the rear.

**Cooled:** By water. A water jacket surrounds the barrel.

**Cyclic Rate of Fire:** About 500 a minute.

**Position of Cocking Handle:** Protrudes from rear of gun below rear sight. It is shaped like a cross, permitting fingers to be locked around both arms so it may be drawn back against the tension of the recoil spring.

**Type of Fire:** Single shot or full automatic. Like the Vickers, this gun is fitted with traversing handles and fired by a thumb accuated trigger in between the two handles. Directly above this thumb trigger is a lever which when swung over **to the left** permits one shot to be fired each time the thumb trigger is pressed. Pushed up into the **vertical** center position it is safe. Pushed over **to the extreme right**, it fires automatically as long as the trigger is pushed in by the thumb.

**Note:** A special cooling device is provided with this gun which permits the water jacket to be connected with a can holding about 2 $\frac{1}{2}$  gallons of water; and a pump which circulates the water through the jacket.

## LOADING AND FIRING

magazines are very easily damaged, and this alone offsets the apparent advantages of the system. The box actually consists of 10 separate magazines connected.

A tip on the magazine follower in each section protrudes from the back. This tip may be held down by the thumb of the left hand while the base of the cartridge is forced down the front of the follower, and slid in under the locking lips of each section. Five cartridges may thus be fed down into each of the magazine wells.

2. This magazine is inserted in guides in the feed box from the **left hand side** of the gun. As each cartridge is chambered, the individual spring in the compartment forces the next cartridge up in line to be picked up by the forward motion of the breech block. When the fifth and last cartridge in the compartment has been fired, the tip protruding from the back of the magazine engages a part of the mechanism which causes the box to **shift over to the right** far enough to bring the

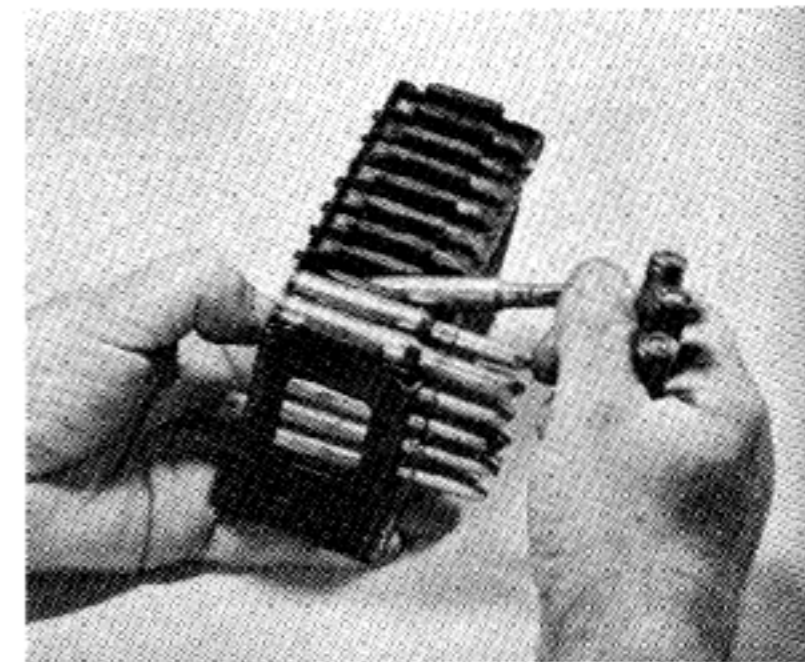

next magazine compartment into line with the firing chamber. When completely empty the magazine is expelled from the gun on the right side.

3. The hinged plate covering the ejection opening on top of the gun in front of the rear sight is now lifted up. (Empty cartridges are thrown out through the top of this weapon.)

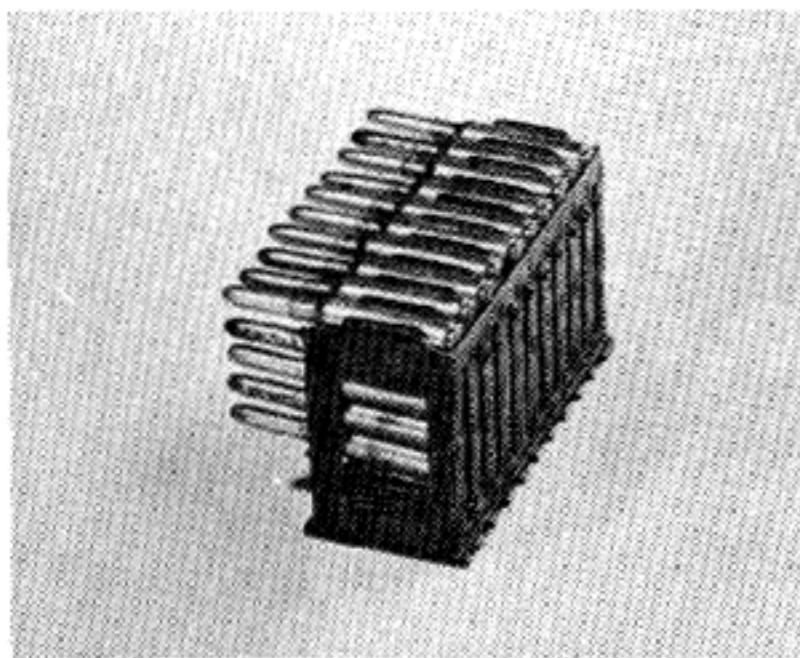

1. **To load the magazine:** This weapon uses a trick magazine feeding system known as a mouse trap magazine. In theory this device provides far more flexibility than is possible with a belt feed mechanism. The magazines are small and compact and can be inserted rapidly, and are expelled automatically from the gun when empty. In actual practice however, the



# ITALIAN REVELLI (FIAT 1914) 6.5-MM MACHINE GUN

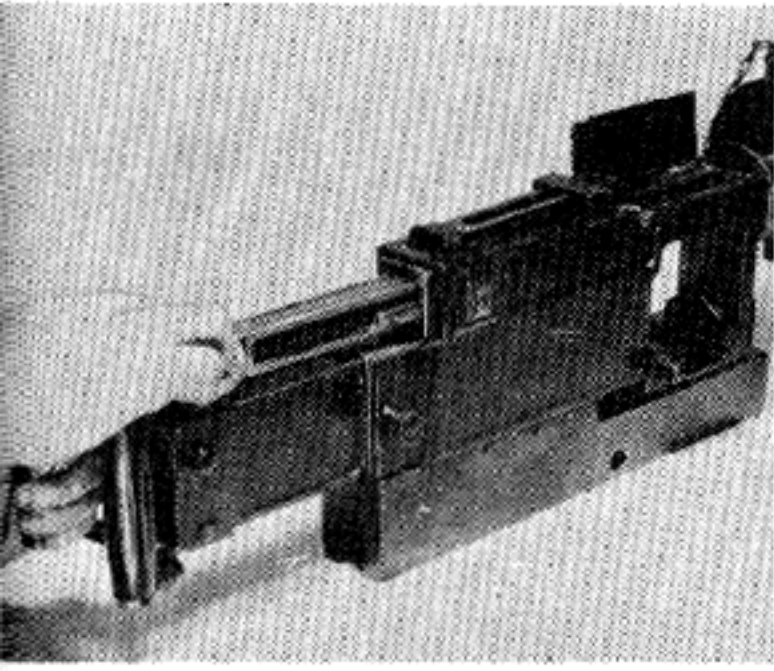

The fingers of the right hand are now gripped firmly around the cross arms of the cocking handle, and the handle is pulled straight to the rear. This compresses the mainspring which is located in the top of the receiver, and when the grip is released, the breechblock drives straight ahead and strips the cartridge into the firing chamber, meanwhile connecting the firing mechanism. The extractor slips over the head of the cartridge as it is chambered, gripping it firmly. Pressing the thumb trigger will now fire the weapon.

4. The firing selector is now set. Over to the left at "Lento" is single shot. In the center at "Sicura" is safe; fully over to the right at "Rapido" is automatic.

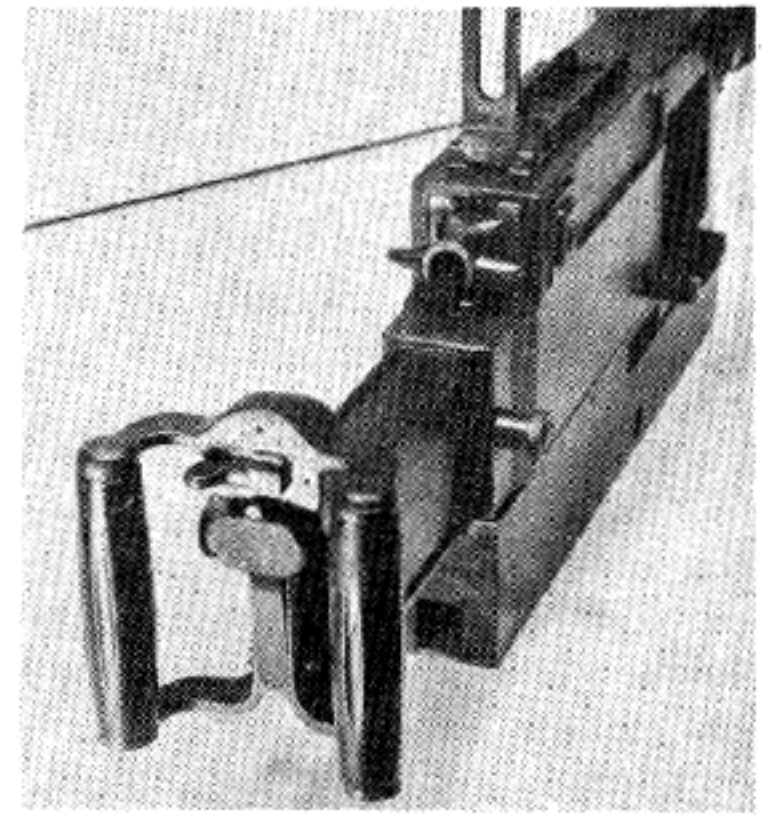

## FIELD STRIPPING

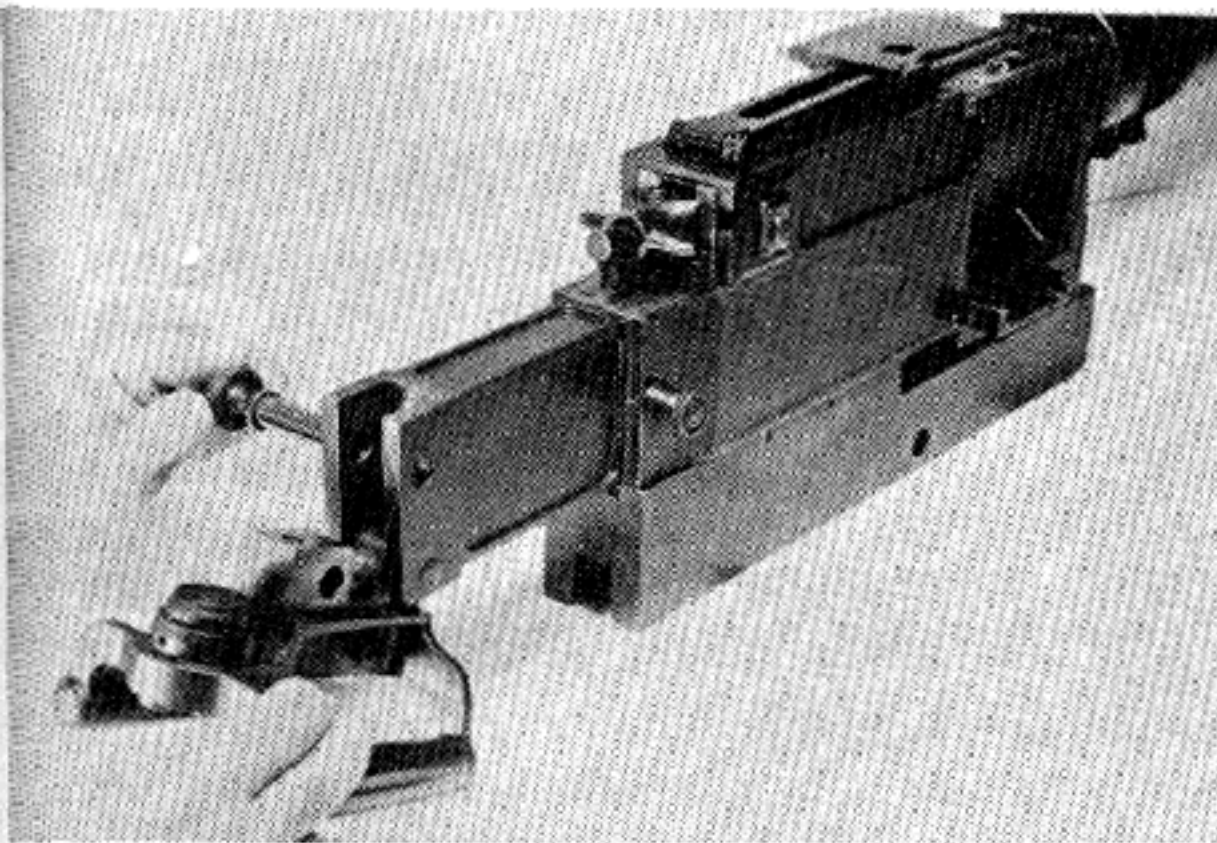

1. A large split pin locks the traversing handle and trigger mechanism through the receiver. Pull this pin out to the left and drop the handles down to horizontal position.

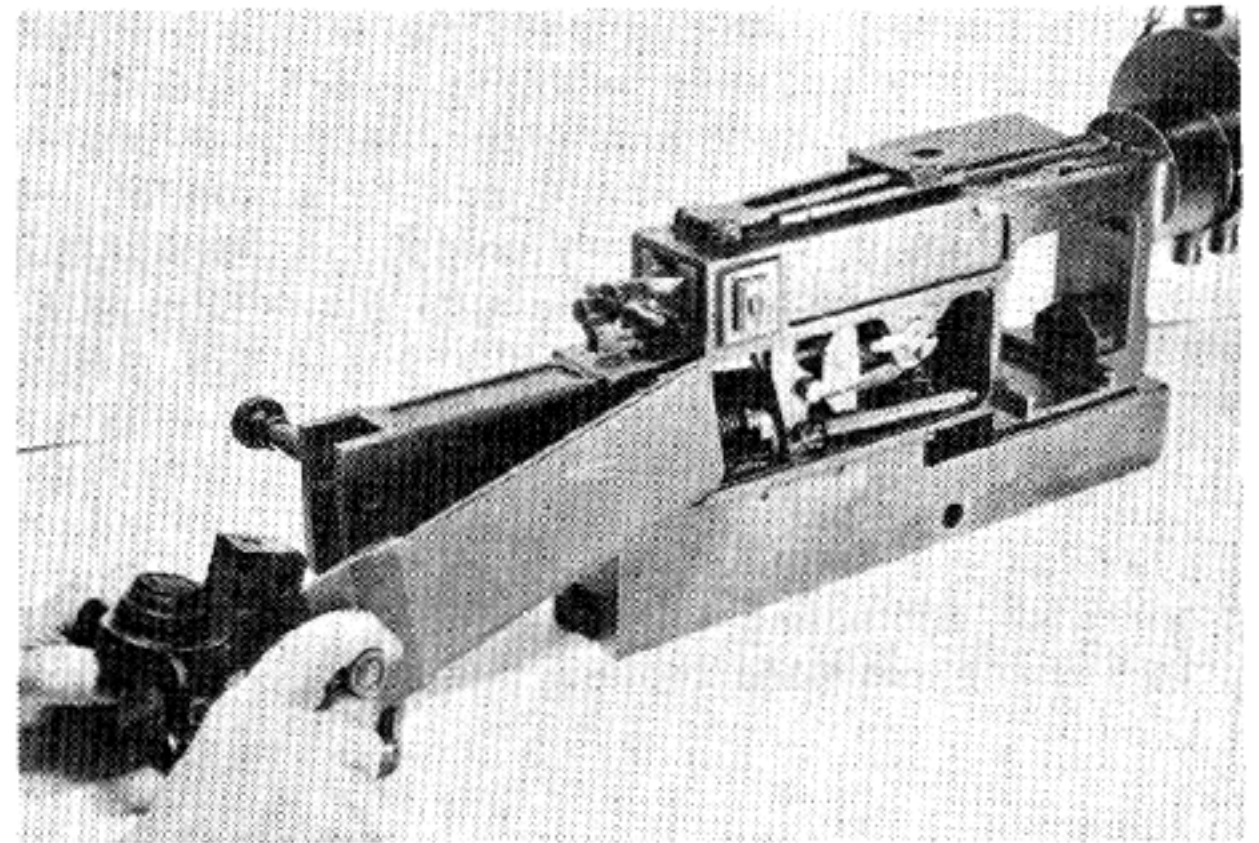

2. Now pull out and back on the spring-held knob on the right side of the gun directly below the cocking handle. This will permit the side inspection plate, to which it is attached, to be pulled directly

back in its guide and out of the gun. This exposes all the operating mechanism except the bolt for inspection and adjustment.

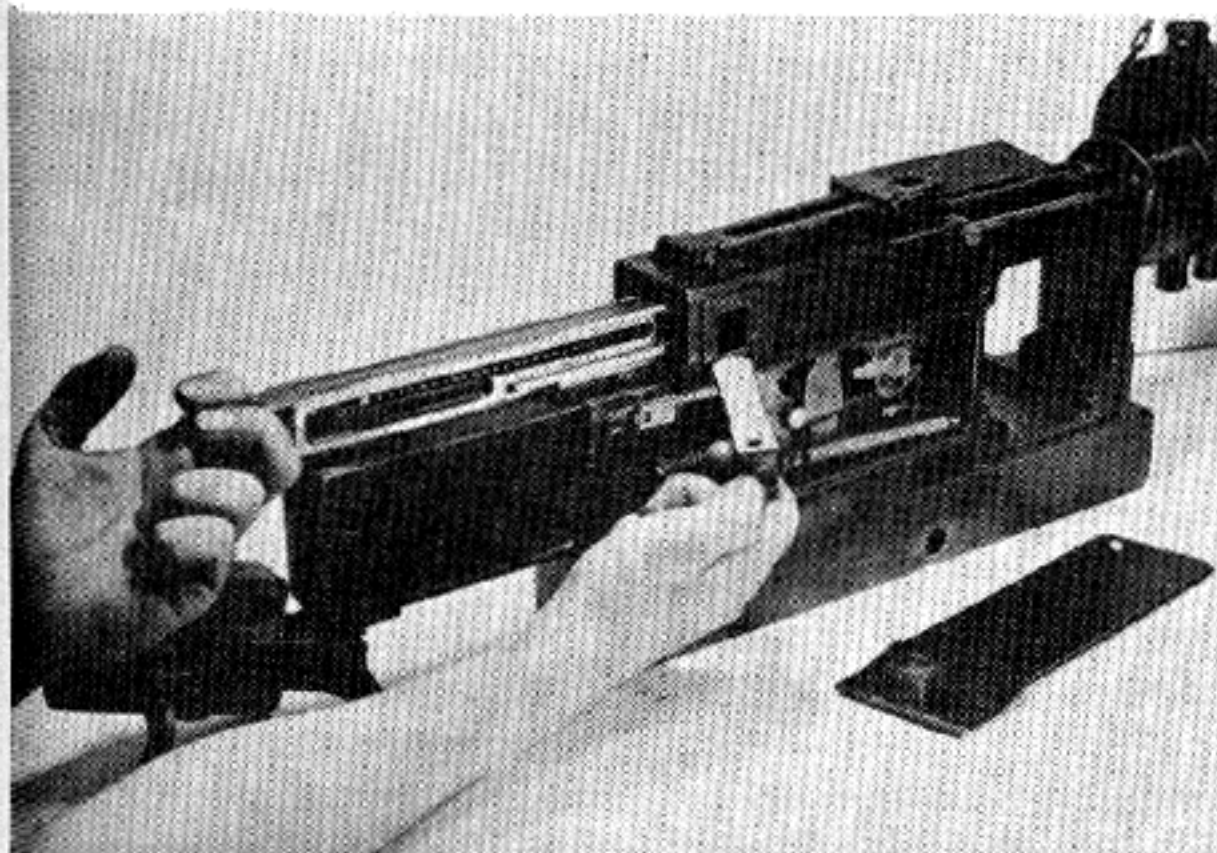

3. Press the spring retaining catch on the receiver locking pin, which is located just below the rear sight base and which passes through the gun. This may now be

removed from the right hand side.

4. The cocking handle complete with the recoil spring and the striker pins may now be drawn with the breechblock directly

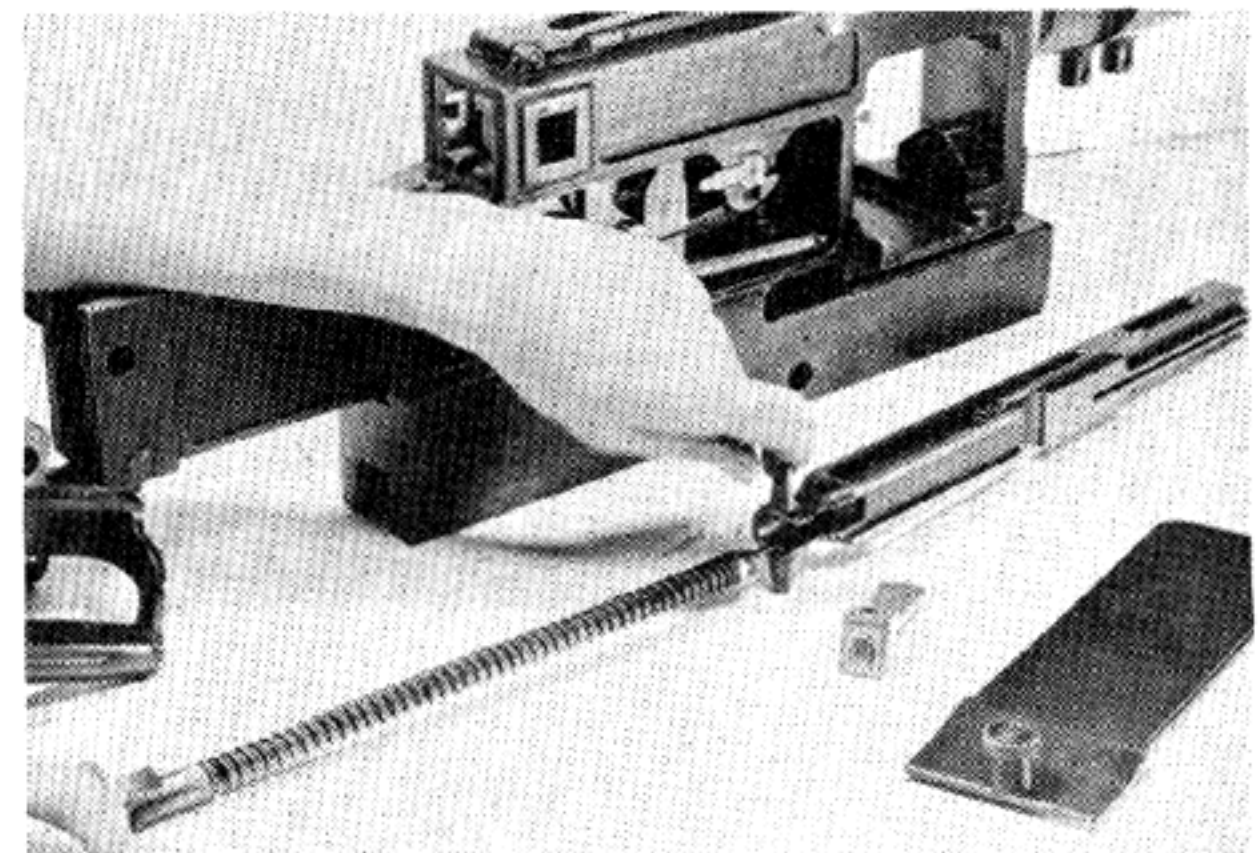

to the rear and out of the gun. Unscrewing the striker from the breech block completes field stripping necessary on this weapon.



# ITALIAN REVELLI (FIAT 1914) 6.5-MM MACHINE GUN

## HOW THE GUN WORKS

**Starting with the gun loaded and cocked, the action is as follows:** Pressing the thumb trigger moves the bent of the sear out of contact with the bolt which is situated in the breech block and permits the striker to run forward under the influence of its compressed spring and discharge the cartridge in the firing chamber. As the bullet is driven down the barrel, the rearward action of the gas against the cartridge case pushes back against the breech block; the barrel, sleeve and breech block move back locked together for a distance of about 4mms. This locking is accomplished by a wedge which can rotate about a fixed axis at right angles to the bore axis. As the breech block goes back, this wedge is forced to rotate **to the rear** and in so doing passes through a slot in the underside of the sleeve bearing against it at a shoulder, and forcing the sleeve and barrel to the rear. At that point the wedge is moved entirely out of engagement with the breech block which continues to travel backwards under the momentum imparted to it by the blowback (or "Projection of the Spent Case" as it is technically called). A nose on the underside of the breech block holds the wedge down during the remainder of the rearward action. (This wedge can be reached when the right hand side plate is removed. It can be adjusted in one of three fixed positions to permit control of the jamming effect of the wedge enabling the gun to work smoothly by increasing or decreasing this thrust.)

During the rearward motion the extractor pulls the

empty cartridge case out of the chambers, strikes against the ejector, which hurls it through the top of the gun.

As each magazine compartment is empty, the projecting tip at the rear of the compartment raises a pawl which permits the feed ratchet arm to push the magazine over to the next compartment.

A strong coil spring attached to a connecting rod, one end of which hooks to a claw on the bottom of the rotating wedge, and the other end to an adjustable spring attached to the frame of the gun, is extended during the rearward motion, providing energy for the return motion.

Meanwhile as the breech block travels to the rear, its spring is compressed against a head of the receiver locking pin which runs through the gun in front of the cocking handle.

When the force of the recoiling action has been expended, the spring in the lower part of the receiver, which is attached at one end of the frame, pulls on the clamp at the bottom of the wedge and draws the sleeve and barrel forward as the striker pin spring acts to force the breech block forward while the sear holds the striker itself back in engagement.

In its forward course, the breech block strips the cartridge from the magazine and chambers it. The weapon is now closed and ready for the next forward movement of the bolt which will start the cycle over again.



# ITALIAN MANNLICHER-CARCANO

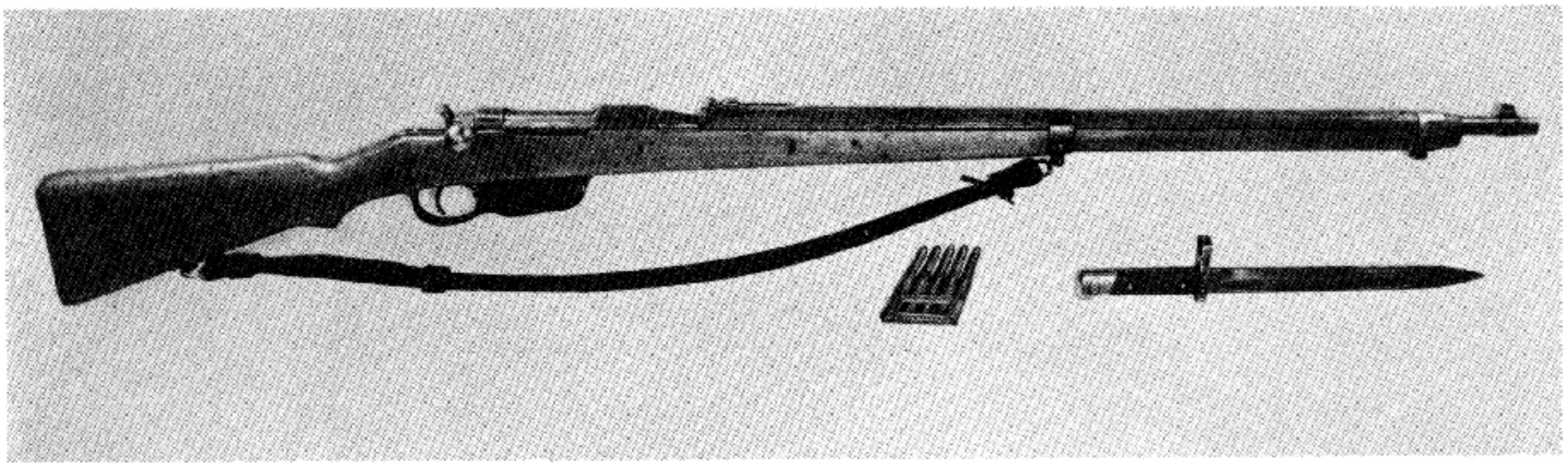

**Caliber:** 6.5mm Italian service. When the Italians entered the war, standard caliber was 6.5mm. They later put in use a rifle in caliber 7.35mm.

**Magazine:** Mannlicher type. In this weapon, the cartridge clip is inserted together with the cartridges into the top of the rifle.

**Barrel Length:** 30<sup>3</sup>/<sub>4</sub>"

**Overall Length of Rifle:** 4' 2<sup>3</sup>/<sub>4</sub>". With bayonet about

1' longer.

**Weight of Rifle:** 9 lbs. Bayonet weighs about 13 ozs. more. The 7.35mm caliber weighs about one pound less than the smaller caliber.

**Sights:** Barleycorn front and V rear, adjustable 600 to 2000 meters.

**Magazine Capacity:** 6 cartridges.

## LOADING AND FIRING

The bolt being raised and pulled back to the rear by the bolt handle, a loaded clip is inserted in the breech and forced down into the receiver. Pushing home the bolt handle drives the cartridge into the firing chamber, and turning the handle down revolves the locking lugs into their recesses, locking the weapon. The manual safety resembles that on our own Springfield rifle. When

the weapon is cocked, the thumbpiece can be swung over to the right putting the rifle at "Safe." Over to the left the safety is inoperative and the weapon can be fired by pressing the trigger.

As in the case of the Springfield, if the bolt is not properly closed it will be closed by the cocking piece as it moves forward. This will usually result in a misfire.

## THE MANNLICHER SYSTEM

While this system resembles that of a Mauser, it has some differences. The bolt lever is set further forward than is customary with the Mauser system.

The principal difference however is in the magazine construction. There is no bottom plate covering the magazine opening as in the Mauser type. In place of the standard magazine, there is a spring-supported arm on the underside of the receiver. When the clip is loaded in from the top with its six cartridges, it compresses this spring arm so that the arm can force cartridges up into line as the bolt is worked. This arm presses against the cartridge case and not against the clip. As a result when the last cartridge has been chambered, the empty clip falls clear through the bottom opening.

**Stripping:** Turn down the retaining catch on the right side of the receiver, pull the trigger and the bolt may be drawn back out of the weapon.

## NOTE ON ITALIAN RIFLES

Besides the two models mentioned the Italian Army was equipped with a wide variety of Carbines and older model bolt action weapons.

An automatic rifle of 6.5mm caliber was used to some slight extent. This is called a Reveilli. So few were in use or manufactured that a detailed description is not warranted.

The wide variety of rifles in use by the Italians during this war (at least 15 types can be identified) all have one thing in common, all are poor military weapons in comparison with United States, British, German or Russian equipment.

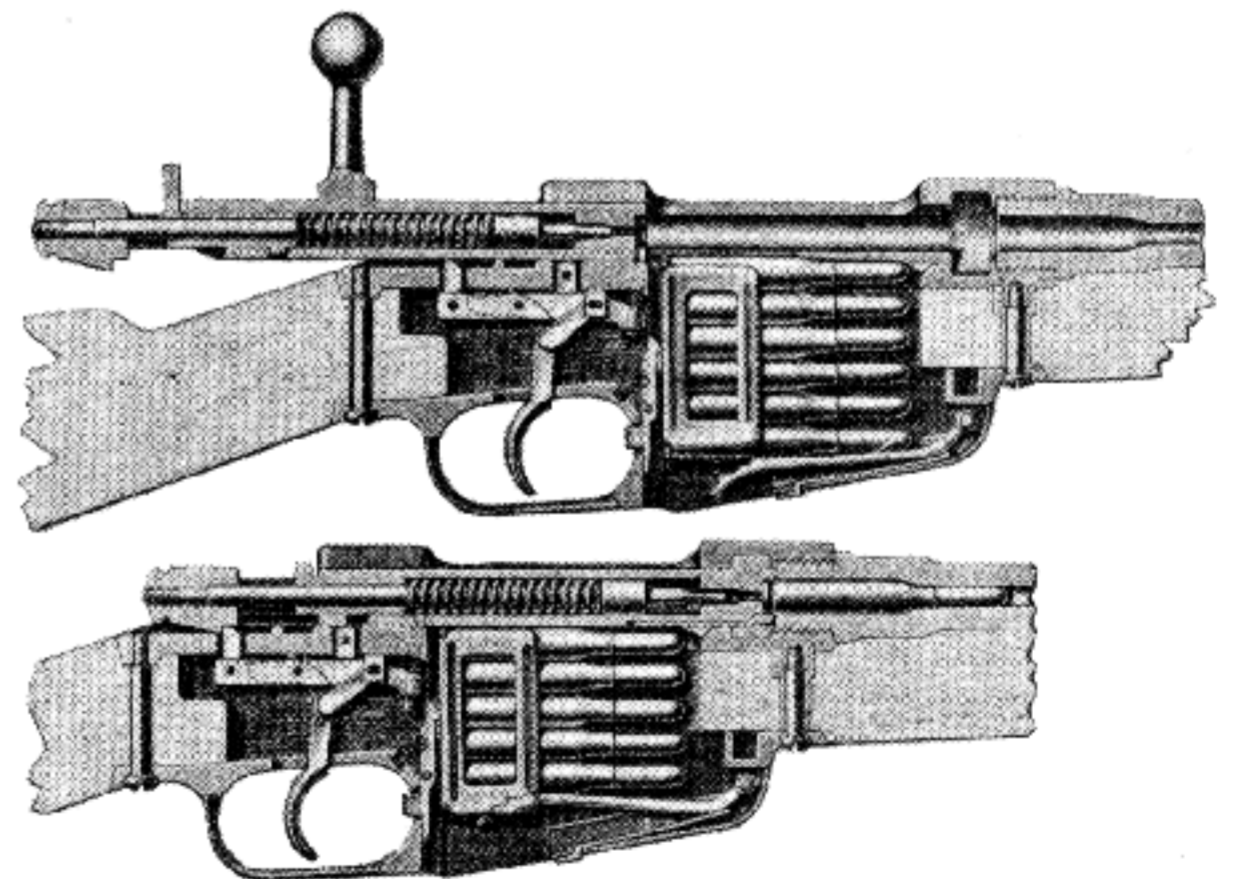



# ITALIAN BREDA 6.55-MM AND 7.35-MM 30 MACHINE GUN



**Caliber:** 6.55mm or 7.35mm. While this gun was originally designed to take the 6.5mm Italian Service cartridge, many will be found chambered to take the 7.35mm cartridge used by the Italians in the last few years. Note: The larger caliber is sometimes referred to as a Model 38.

**Feed:** A magazine is attached to the right side of the gun where it swings forward when unlocked. It is fed by a clip. Capacity is 20 cartridges.

**Overall Length of Gun:** About 40".

**Weight of Gun:** 23½ lbs. with bipod mount.

**Sights:** Barleycorn front and V-rear.

**Battle Sights: Set for 300 Meters:** Sights adjustable to 1500 meters but actually not intended for use over 450 yards.

**Gun Operated by:** Recoil and inertia.

**Cooled:** Air. Barrel has jacket. Cooling very poor. As this gun fires from a closed bolt, no air can circulate down the barrel through the ejection port between

shots.

**Locked:** By rotating fermeture nut.

**Cyclic Rate of Fire:** 450 to 500 per minute. (Actual rate delivered is about 120 per minute.)

**Position of Cocking Handle:** On right side of gun. Gun ejects from lower left.

**Type of Fire:** Full automatic only. Note: gun has bipod mount at end of barrel casing below front sight. A pistol grip is provided; also a butt strap extending from the upper end of the butt, and a special ground extension to the rear of the pistol grip.

**Caution:** When firing this weapon, cocking handle **should always be drawn back** when the firing is stopped. It can be locked in the rear position by pushing in the catch just behind the handle. If this is not done, the heat in the barrel may explode the cartridge. To release the cocking handle pull it back to the rear. This will pull the catch out of engagement and let the breech block go forward.

## LOADING AND FIRING

To load magazine. The magazine projects from the right side of the gun. Push in the magazine catch located on the rear side of the magazine and turn the magazine forward on its pivot.

Draw back the cover over the ejection opening on the left side of the gun.

Insert the clip in the magazine, pushing it in until all the cartridges have been caught by the cartridge catch.

Now withdraw the clip. Swing the magazine back into position until it locks. Pull the cocking handle to the rear as far as it will go and let it run forward. If weapon is not to be fired immediately, push the safety catch at the rear of the receiver. Otherwise press the trigger and the gun will fire automatically as long as there are any cartridges in the magazine.

## FIELD STRIPPING

A barrel catch is located on the left side of the gun at the forward end of the receiver. Pull this out and lower it. The barrel will now turn about 90° to the left. Grasp the barrel handle to turn it and slide the barrel forward to clear the receiver, then withdraw it to the rear.

A butt catch is located below the rear sight. Push it forward to release the butt. Now twist the butt from right to left and draw it out to the rear together with the recoil spring and its guide and the buffer spring. Be careful of the tension of these springs as the butt is removed.

Pulling back the cocking handle will now permit you to withdraw the breech block, the firing pin and its spring. Pulling the cocking handle further to the rear now permits it to be pulled out of the right side of the receiver.

At the rear of the cover on the top of the gun above the ejection port, is a turning catch. Turn it to the right, lift the cover, pull out the hinge pin in the cover and remove the cover itself.

Slide the magazine off its hinge.

Remove the magazine mouthpiece plate (this is just to the rear of the magazine mouthpiece). Slide the



# ITALIAN BREDA 6.55-MM AND 7.35-MM 30 MACHINE GUN

mouthpiece to the rear and lift it off.

Now lift out the ejector.

Turn the gun upside down. With a small screw driver or the point of a bullet, press in the locking catch cover retaining stud. The catch cover may now be slid off to the rear.

Push out the locking catch hinge pin and remove the catch and its spring.

Turn the gun right side up. An H-piece retaining catch will be seen on the left of the receiver. Lift it horizontally and withdraw it to the left.

Move the H-piece locking nut as far as it will go to the rear and lift it out. The locking nut may now be removed.

No further dismounting is ordinarily necessary.

## HOW THE GUN WORKS

Like the Revelli, Fiat and Schwarzlose, this gun is operated partly by recoil of the moving parts and partly by what is called "projection of the spent case," which means simply blowback as the empty case is forced back against the face of the bolt. This system, as in the case of the early Japanese machine guns, requires the incorporation in the gun of a special device which will spray oil on the cartridges as they are inserted in the firing chamber. This device also lubricates the moving parts. As in the case of the Thompson submachine gun, unless this oiling action functions properly, trouble will be encountered.

Another grave defect in this weapon, as already pointed out, is that it fires from a closed bolt. While this is an excellent system in a heavy machine gun, in a light one it can be very dangerous. As the barrel heats up, the cartridge in the chamber may be "cooked off" from the barrel heat.

Starting with the gun loaded and cocked, the action is as follows: As the trigger is pressed it rotates on its pin, causing the rear end to force the sear release forward and cam the sear out of contact with the rear of the firing pin; this compresses the sear spring and also releases the firing pin which is driven forward by its spring and strikes the primer of the cartridge in the firing chamber.

**Return Movement of the Action:** As the bullet travels down the barrel, the gas pressing rearward against the empty cartridge case drives back against the face of the bolt. This pushes the bolt, bolt lock and the barrel (which at this point are securely locked) a short distance to the rear. During this travel, the lug on the top of the

bolt lock cams to the left. At the proper moment, this unlocks the bolt lock and permits the bolt to travel independently to the rear carrying the empty cartridge case gripped by the extractor. An ejector traveling in the right side of the bolt swings out on spring tension and the right side of the head of the cartridge strikes against it, pivoting it on the extractor and hurling it out the left side.

The firing pin is also carried to the rear by the bolt and its spring is compressed between the forward shoulder of the pin and the buffer housing. The rear end of the pin passes through the buffer and into the sear housing where it cams the sear down compressing its spring until the sear notch is directly above the sear. Then the spring forces the sear up to grasp the firing pin and hold it to the rear. A safety device is incorporated which prevents the firing pin from going forward except when the bolt is fully locked.

**Special Note:** The oil device. Although it is unlikely that any machine weapons will ever again be manufactured using such a device, a short explanation of the functioning of this pump may be of interest. As the bolt goes forward a piston is cammed up into a cylinder in the oiling device by the bolt. This exerts a driving force on the oil which forces it out a small spout on the right side of the cover. This spout leads to the mouth of the magazine, and thus sprays oil over the cartridge case of the first cartridge. During the rearward motion of the bolt, the oil piston rides in a groove on top of the bolt until the bolt nears its rear position. Then the piston is cammed down a beveled surface releasing pressure and letting in air for the next forward stroke.



# ITALIAN FIAT 8-MM 35 MACHINE GUN

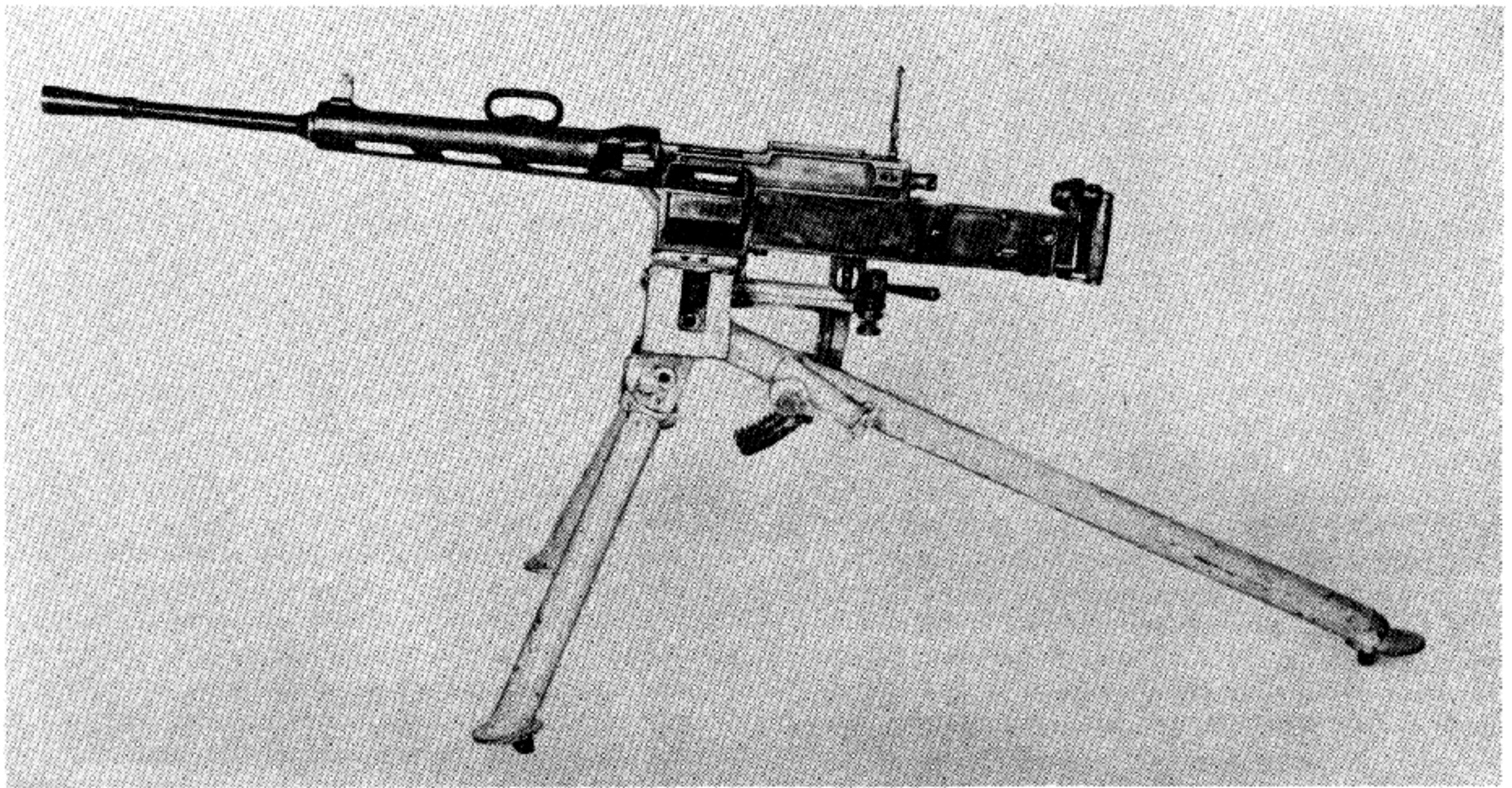

**Caliber:** 8mm.

**Feed:** 50 round belt; additional units may be added to this.

**Overall Length of Gun:** About 50".

**Weight:** About 40 pounds. Weight of tripod: about 50 pounds.

**Gun Operated by:** Recoil.

**Locked:** Semi-locked. This is a modification of the Revelli machine gun.

**Position of Cocking Handle:** Directly below and behind rear sight. Same as Revelli.

**Cooled:** Air cooled. Has barrel jacket and heavy barrel. As this weapon fires from a closed bolt, the barrel can get dangerously hot after comparatively a short amount of firing.

**Cyclic Rate of Fire:** About 600 a minute.

**Type of Fire:** Single shot or full automatic as for Revelli.

**Sights:** Adjustable 200 to 2400 meters.

## LOADING AND FIRING

Open ejection cover on top of gun. Insert belt (make sure cartridges are on top), into feed block from left side of gun.

Pull the cocking handle as far back as possible. Pull the belt through the feed block as far as it will go. Release cocking handle and let it fly forward under com-

pression of the recoil spring. Set the selector lever as on Revelli for safe, single, or full automfire. **Note:** A fire control lever is mounted on the left side of the receiver ahead of the traverse handle. Set this in vertical position and the gun will be slowed down; set it at horizontal and it will speed the gun up.

## STRIPPING

**Barrel Removal:** In the left front end of the receiver is the barrel catch. Push this in. Turn the barrel handle to top of its slot and push the barrel forward until its end comes clear of the barrel casing. Now lift the rear of the barrel out of the slot and turning the barrel to the right, withdraw by muzzle end from front opening.

Pull out the heavy pin passing through the receiver at the rear near the traversing handle (as for Revelli) and pull down the traversing handles.

Pull out the side plate cover catch and force the cover back to the rear.

Lifting the pawls and turning the rear end of the pawl release lever up until the featherway coincides, will permit the pawl release lever to be lifted out.

Push down the feed pawl lever actuating spring and its rod. Turn and remove it.

Now push up the feed block cover and lift it out. Further stripping is essentially the same as for Revelli.

## HOW THE GUN WORKS

Except for the feed mechanism, this weapon is essentially the same as the Revelli. Smooth functioning depends to a large extent on easy extraction of empty cartridge cases. Therefore an oiling device is necessary to lubricate the cartridges as they are fed into the firing chamber. Proper oiling of all parts is very necessary in this gun.

This necessity for special lubrication, together with the complicated semi-locking system, and the fact that firing from a closed bolt means that the barrel heats so rapidly that it must be changed after three or four belt lengths have been fed through the gun, all combine to make this a very poor type of weapon.



# NOTES ON ITALIAN WEAPONS

## SUB-CALIBER JUVENILE RIFLE

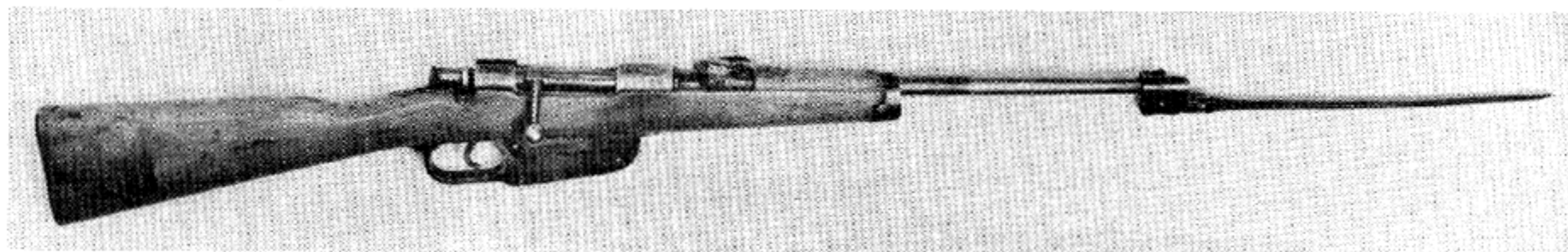

Among the weird weapons of all history, perhaps the outstanding one is the sub-caliber rifle developed under Mussolini to arm and train the youth of his nation. This weapon is almost a line-for-line reproduction of the Mannlicher-Carcano Italian Carbine. It is even designed with the Mannlicher-Magazine, to be fed from the top with a clip of special caliber cartridges.

To add to the viciousness, a folding bayonet is attached to the muzzle.

These weapons were issued to children as young as six

years of age for training as "warriors."

Note that this is in no sense a sporting rifle of the popular 22-caliber type used for hunting, target work, or sporting work. It is strictly a military-type weapon in every sense of the word, built specifically to warp children at their most impressionable age.

In passing it is worthy of note that the Japanese adopted this idea from the Italians, and in recent years have organized youth groups under the age of 10 and equipped them with similar rifles.

## THE VILLA PEROSA

This weapon was designed by the Italians towards the close of the last war. In some models it was used on airplanes. Equipped with bipod mount, it was issued as an Infantry weapon. With a special fastening on the centerpiece, it was optimistically mounted on bicycles! This weapon was one of the earliest type of what we have come to call the submachine gun. It fires the 9mm Glisenti Pistol cartridge (which is the same as the German Army Luger cartridge except that it is very much lower powered).

The gun is fitted with two barrels and two separate magazines. The firing grips are reminiscent of the Vickers, as are the thumb triggers.

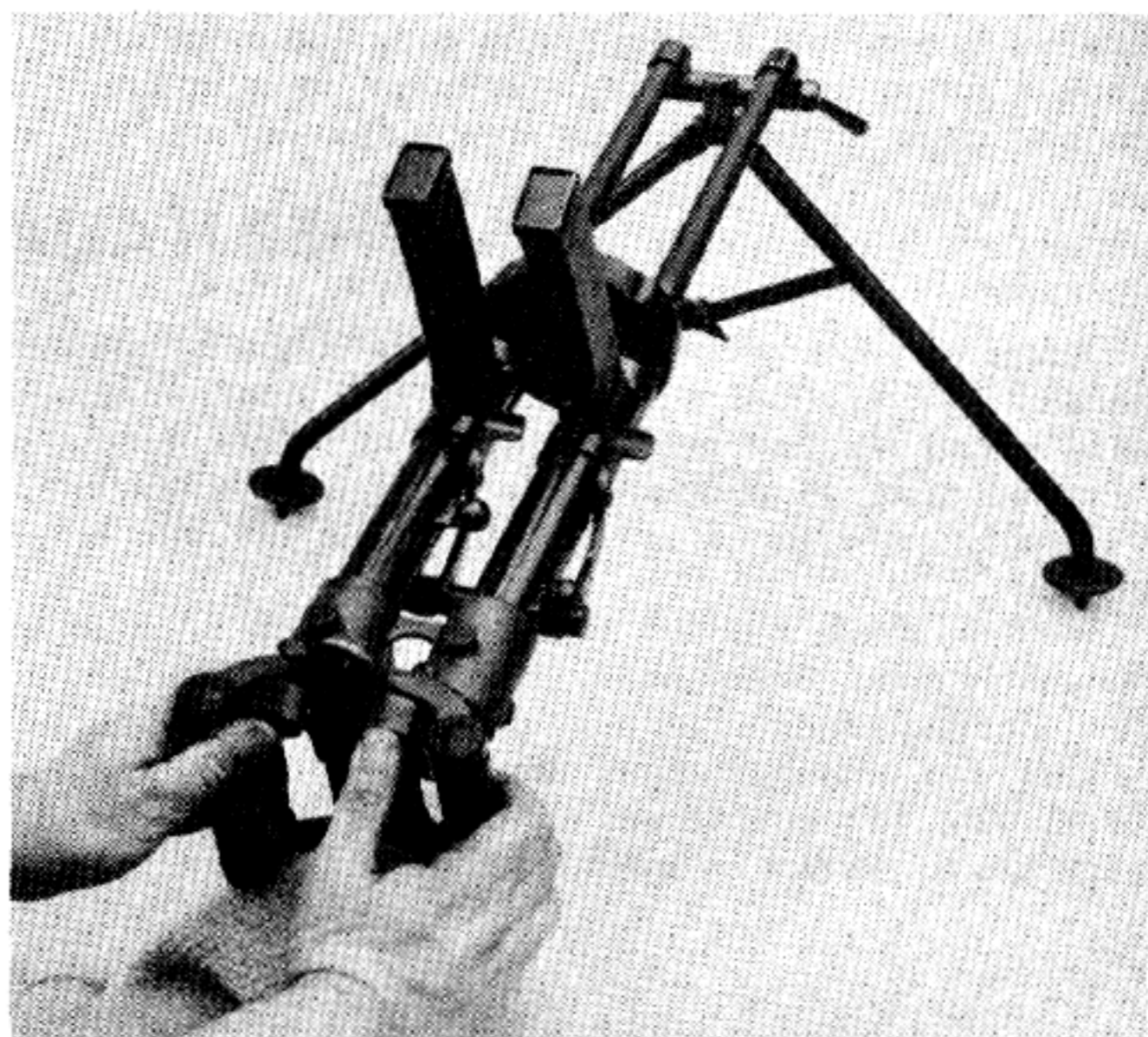

## LOADING AND FIRING

The locking levers directly behind the magazines are rotated until the slots in the lock line-up and permit the magazine to be pulled out from the top of the receiver.

The magazines are loaded exactly as for automatic pistols. The normal capacity is 25-cartridges each. Some magazines will hold 32-cartridges.

Replace the magazines in their locking slots and fasten the retaining catches. (These differ in several models of this freak weapon.)

Just to the right of each magazine housing is a lever. Pull each lever back as far as it will go and permit it to fly forward. This loads the weapon.

A thumb trigger is provided for each barrel. Thus they may be fired singly or together. A safety lever is

mounted in the gun between the two gun triggers. A gas regulator device is incorporated.

With the mount pictured this gun weighs about 18 lbs. It is operated by blowback pressure in the fashion of the early Bergman submachine guns. No cooling device is incorporated, and the weapon heats up very rapidly. This gun will empty the magazines so rapidly that it is impossible to distinguish between shots.

The rate per barrel is 700 to 800 per minute. The practical value of this gun is nil. While it is no longer manufactured, many have turned up among the Italian forces. They usually come packed in a wooden chest with 10 or 20 magazines.



# NOTES ON ITALIAN WEAPONS

## BERETTA AUTOMATIC CARBINE; MOSCHETTO 9 mm



This also is a blowback weapon of the general Bergmann order. The magazine is mounted on top of the gun. The magazine release catch is in front of the mounting. This gun fires from an open bolt. The cocking handle is on the right side of the receiver just to the rear of the magazine. It is pulled back and revolves. (Note that this revolving action is not a lock.) As the bolt goes forward, it strips a cartridge from the magazine into the firing chamber and fires it. Under the influence of the blowback, the empty cartridge case is expelled through the bottom of the gun. The magazine follower spring drives the next cartridge down in line. The bolt goes to the rear and stays open waiting for

the next pull on the trigger.

Magazine may hold 20, 25 or 32-cartridges. Its rear face is somewhat cut away so that the primers of the cartridge in the magazine are visible to the man shooting. He thus has an idea of how many cartridges are in the magazine at all times.

It will be noted that this weapon is fitted with the same type of folding bayonet provided on the sub-caliber rifles issued to children. Pressing in a catch permits this bayonet to be swung out on a hinge and locked in position. When folded it fits into a slot on the underside of the forearm.

## OTHER ITALIAN WEAPONS

Dozens of types of inferior arms were in use by the Italians, ranging from old model Vetterli rifles which were among the first ever developed to handle metal cartridge cases, to atrocious Bodego revolvers in which the empty cartridge cases have to be dug out with a knife.

The 8mm Breda medium machine gun model 37 is a reasonably good, though heavy, gas operated, air-cooled gun. Cocking handle is on the right side, and traversing handles and thumb triggers are provided as in the Revelli gun. This weapon was not issued in large enough quantities to warrant an extended description.

Yet another Italian type, taking an 8mm cartridge which is **not** interchangeable with the 8mm Breda, and hence added to the intolerable supply problem of the inefficient Italian Ordnance Department, is the Fiat (or Safat as it is sometimes called) light machine gun. This too is a gas operated, air-cooled weapon. While the design is not bad, it is woefully inefficient when compared with accepted military standards.

Italian equipment may best be summed up in words variously ascribed to U. S., British and even German ordnance men. It runs like this: "Some factories in Italy have been manufacturing firearms since the 16th century. They must be fine weapons; because all of them were in use by Mussolini's army!"

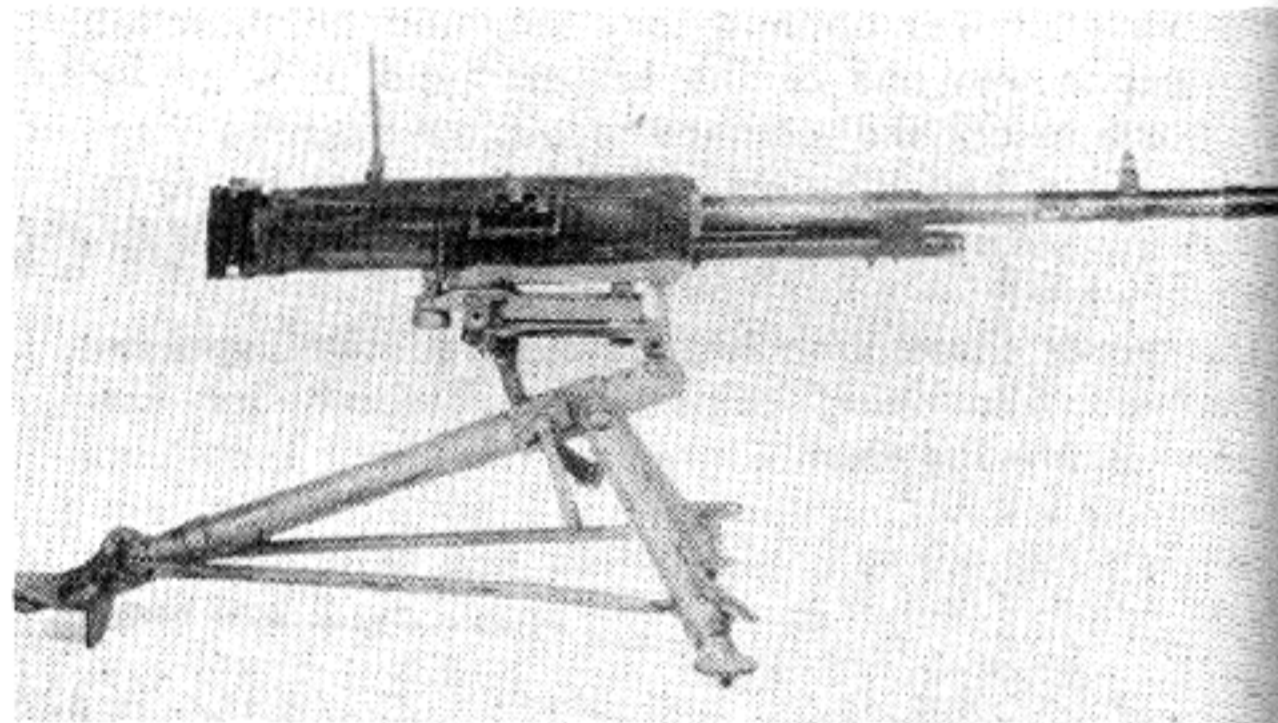

Breda 8 mm Medium Machine Gun, Model 37

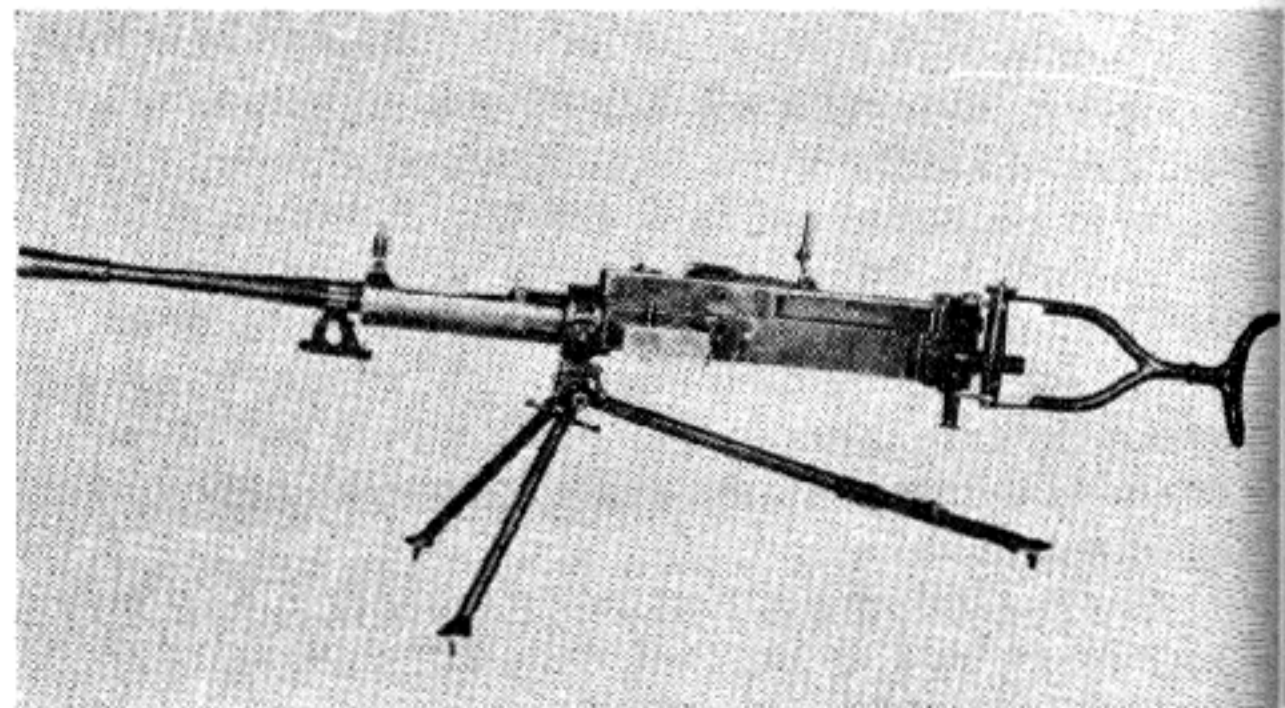

Fiat Light Machine Gun 8 mm



# JAPANESE NAMBU 8-MM 1925 AUTOMATIC



**(The Standard Japanese Service Pistol)**

**Caliber:** 8mm. This is a specially designed cartridge, its general appearance being bottle-necked and patterned after the Luger .30 cartridge. Its diameter however is larger than the Luger .30 which is 7.65 mm.

**Magazine:** Box type single line, capacity 7 cartridges.

**Muzzle Velocity:** About 860 feet per second.

**Weight of Bullet:** 102 grains, special hard lead bullet, without jacket. Also steel jacketed.

**Muzzle Striking Energy:** About 230 pounds.

**Barrel Length:** About 4½".

**Overall Length of Pistol:** About 9".

**Weight:** About 30 ozs.

**Sights:** Front sight fixed. Rear sight has sliding leaf and is adjustable for elevation.

**Accurate Range:** 75 yards.

**Maximum Range:** About 1400 yards.

**Pistol Operated By:** Recoil.

**Locked:** By locking bolt swinging up through barrel extension into underside of breech lock as in the Glisenti and Mauser type pistols.

**Type of Fire:** Single shot only.

**Magazine Release Catch:** Button as on Colt .45 and

Luger.

**Position of Bolt When Last Shot is Fired:** Open. When magazine is extracted or loaded magazine inserted, pulling back on bolt head slightly will free the bolt and permit it to run forward.

**Safeties:** (a) Automatic grip safety directly under trigger guard. As in Colt and Glisenti pistols, when pistol is gripped firmly, safety grip moves in, permitting pistol to be fired. (b) Automatic disconnecter prevents pistol from being fired until bolt moves forward and breech is completely locked.

**Note:** This pistol comes in a very heavy leather or wooden holster stock, which can be attached to the slot in the handle of the pistol to form a carbine. Unlike the Mauser pistol, this holster is not long enough to make a satisfactory shoulder stock. Instead it is provided with a telescopic extension which may be pulled out to lengthen the shoulder stock. This device is of questionable value in actual combat use, as the sighting arrangements for firing with extended hand as in pistol operation, or from a shoulder stock in carbine fashion are entirely different.

## NAMBU AUTOMATIC PISTOL, NEW MODEL

This is a production model differing in many essentials from THE ORIGINAL MODEL of the Nambu pistol. It has no grip safety but is provided with a thumb safety directly above the trigger on the barrel extension or sleeve. Swinging this around in an arc sets the pistol at **safe**. Sights on this model are **fixed**. Cocking piece or bolt differs from that of the earlier model in being circular. The recoiling parts are rather differently set up. Trigger guard is of a peculiar elongated shape intended to permit the pistol to be used with a heavily gloved finger. This is a typically Japanese characteristic found in many weapons produced in Japan. While the grip is patterned after the Luger pistol, the action is patterned more after the Glisenti pistol.





# JAPANESE NAMBU 8-MM 1925 AUTOMATIC

## TO LOAD

1. Insert loaded magazine in handle, push in until it locks securely. (Just as for Colt and Luger Automatic.)

2. Grasp bolt wings securely, pull bolt back as far as it will go, release. The recoil spring, compressed by pulling the bolt back, strips the top cartridge from the magazine, loads it into the firing chamber and snaps the head of the extractor into the cannellure of the cartridge case.

3. **When Pistol is empty:** Bolt stays open. Insert loaded magazine and pull back slightly on bolt. This will release the holding catch and permit the bolt to run forward. (This is adapted from the Glisenti.)

## NEW MODEL

When pistol is empty, bolt stays open. The magazine is withdrawn and the bolt goes forward automatically. When a loaded magazine is inserted, the bolt **must be pulled back** again by hand and released before the firing chamber can be loaded. Note also that when the magazine is out of the handle of this weapon, this pistol **cannot be fired**. Trigger can be pressed only when the magazine is in place.

## FIELD STRIPPING

1. Remove magazine catch from receiver.
2. With bolt held back, pull trigger guard down.
3. With muzzle pressing against a solid surface to remove tension of spring, give breech plug a one quarter turn and withdraw.

4. Bolt may now be pulled out of sleeve. Firing pin may be removed from bolt.
5. Revolve the rear stop to the left and unscrew it.
6. Remove the mainspring and the plug from the front end.

## FIELD STRIPPING NEW MODEL



The head of the firing pin extension protrudes through the center of the bolt nut. Press this in and turn the bolt nut to unscrew it. As it is removed, the firing pin spring will force the firing pin extension out of its seat in the bolt. This permits removal of the firing pin, firing pin spring and firing pin extension.

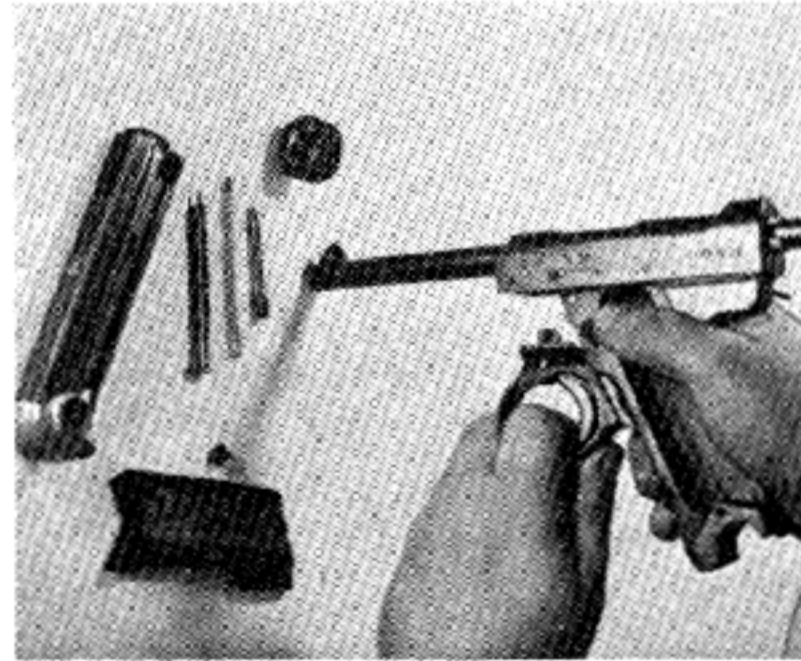

Remove magazine. Press muzzle down on a solid surface to force the barrel back to the limit of its recoil, and while holding it in that position, push in the magazine catch as far as it will go (it is usually well to remove the left hand stock before doing this). While barrel is depressed and magazine release catch is being forced in, pull **straight down** on the trigger guard. This operation usually is a very difficult one. It may be necessary to hitch the trigger guard over a heavy spike driven into a board or some similar object, and while pressing in the catch and forcing back the barrel to pull so that the trigger guard comes down out of the groove in the frame of the receiver.

While the magazine release catch locks in a slot in the upper front section of the magazine, the magazine is also retained near the bottom of the grip by the flat spring which is buckled to catch in a lower notch in the magazine. Thus to remove the magazine it will be necessary not only to push the catch but **also** to pull the magazine with considerable force to free it from the lower spring.



The barrel may now be slid forward on its grooves out of the receiver, bringing the bolt with it. Note that the barrel extension is an integral part of the barrel itself, and that the extension acts as a housing for the bolt.

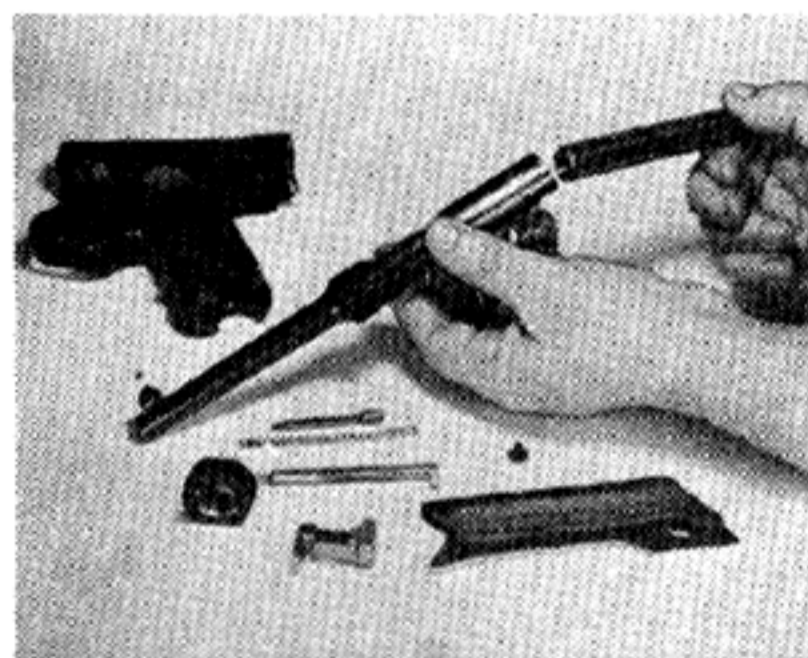

The locking link may be removed from its pivot. The bolt with the recoil springs fitted on each side of it may be withdrawn from the rear of the barrel extension, and if necessary the firing pin may be driven out of the bolt together with its spring.



Pulling the trigger guard straight down permits the trigger assembly to be withdrawn from the receiver. The magazine catch may be now lifted out together with its small spring. No further stripping is necessary. The remaining parts must be removed by driving out fixed pins.



# JAPANESE NAMBU 8-MM 1925 AUTOMATIC

## HOW THE NAMBU PISTOL WORKS

While in appearance and balance this weapon on the outside resembles the Luger Pistol, the mechanism actually is related more directly to the Glisenti. As the cartridge is fired, the breech block locked firmly to the barrel extension by the locking bolt, which is pivoted so it can swing up from below to lock the parts, travels straight to the rear for a short distance with the barrel. The barrel strikes against the barrel stop and is held up in its rearward motion. At this point, the locking bolt reaches a cut in the receiver down which it can swing to unlock the breech block from the barrel. The breech block now continues rearward drawing with it the empty cartridge case which strikes the ejector and is hurled out of the pistol. During this motion the recoil springs are compressed. When the rearmost position has been reached by the bolt, the magazine spring lifts a cartridge in line with the bolt, the compressed mainspring reasserts itself, drives the bolt forward stripping a cartridge; meanwhile the locking bolt swings up on its pivot through the slot in the receiver and locks into the under side of the breech block; and the locked barrel and breech block are thrust home to their forward positions. At this point the disconnecting mechanism removes interference from the striker.

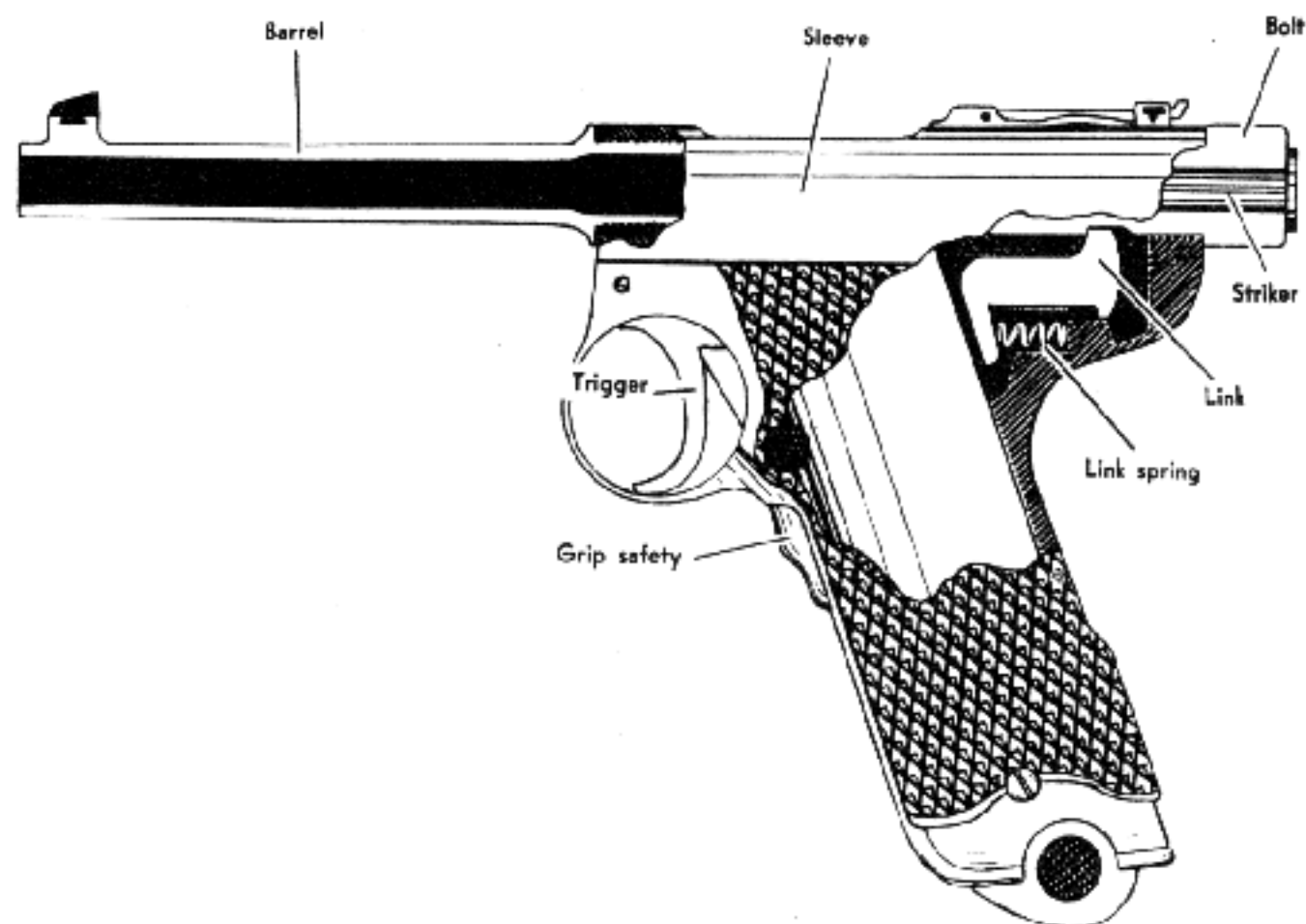

## ADDITIONAL NOTES

A 7mm Model of the Nambu has been reported, said to be used by officers. The author has never seen such a caliber, nor found anyone else who has.

A Smith and Wesson type, hinge frame revolver with a Mauser-style hammer and a curiously shaped grip with

an arrangement permitting it to be fitted to a shoulder stock as a carbine is also used—mostly by Cavalry. It is 9mm Caliber, 6-shot. Its special cartridge develops a muzzle velocity of about 1000 feet per second.

## MODEL 94

Still another type of Japanese pistol is in general use. This is a freakish looking weapon of very complicated design. It is called the model 94 (1934). It takes the Standard 8mm cartridge used in the other two types of auto pistols. The magazine capacity is only 6-cartridges however. The recoil spring in this pistol is around the barrel inside the barrel casing as in the case of the old American Savage pistol. Magazine release is a push button near the trigger guard on the left side. A thumb safety is provided on the left side at the rear of the pistol. Weapon is cocked by pulling back knurled surfaces at the rear of the bolt. The design of this weapon is too poor to merit further consideration. One word of warning is necessary in connection with this pistol however: When the firing chamber is loaded, metal strips are forced out on each side of the receiver. If these strips are pressed in by purpose or accident, the striker will go forward and fire the pistol without the trigger being touched.

This may be merely a matter of poor design—this weapon was originally made for South American export trade.

**Note on 8mm ammunition Jap pistols:** While this ammunition was originally furnished with hard lead bullets, evidently feeding trouble was encountered in actual use. Cartridges issued for Jap service use have steel (not alloy) jacketed bullets; and develop a muzzle velocity of about 860-feet per second.

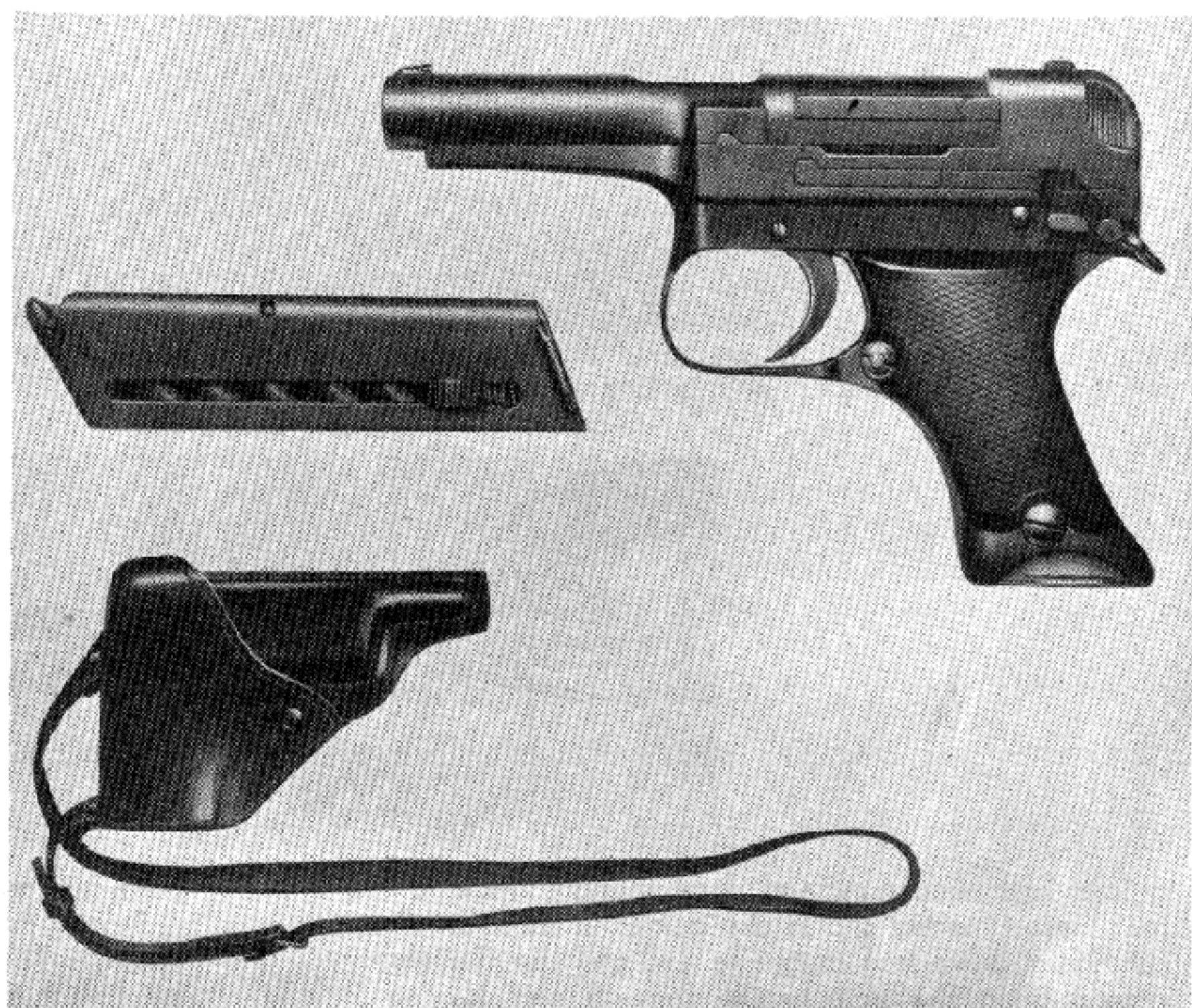



# JAPANESE ARISAKA 6.5-MM

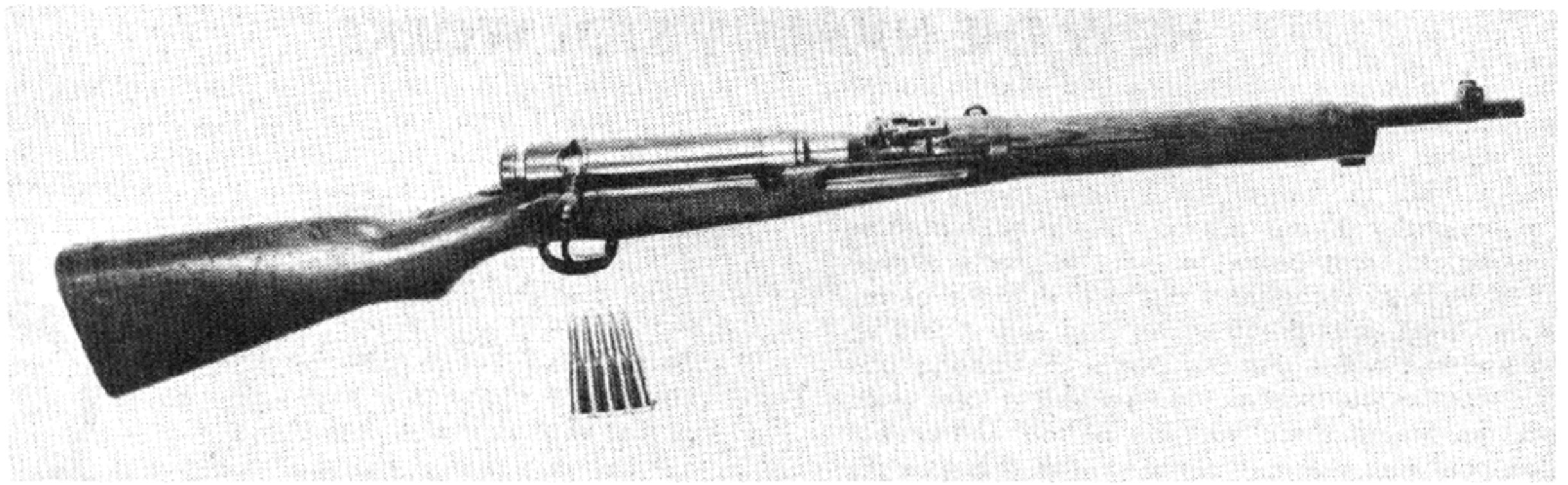

**Caliber:** 6.5mm Japanese Service cartridge (or 7.7mm).

The original caliber of this rifle was 6.5mm. New models have recently been introduced using caliber 7.7mm (.303 inch) ammunition.

**Magazine:** Mauser type 5-shot capacity.

**Barrel Length:** 30 1/3".

**Overall Length of Rifle:** 4.3" (with bayonet 1' 2 1/2" longer).

**Weight:** 8 lbs. 12 ozs. (with bayonet 1 lb. heavier).

**Sights:** Barleycorn front and V-rear.

**Elevation:** From 400 to 2400 meters.

**Type:** This is a Mauser-type with action much like our Springfield.

**Sling:** This rifle has a sling used for carrying. It cannot be adapted as a support for the rifle.

**Cocking:** Like the British Enfield, this weapon cocks on

the forward thrust of the bolt.

**Muzzle Velocity:** About 2700 feet per second.

**Weight of Bullet:** 139 grains, pointed lead bullet with nickel-steel jacket.

**Accurate Military Range:** About 500 yards.

**Extreme Range:** About 4000 yards.

**Bolt Cover:** A sliding metal piece is fitted over the bolt. This is intended to keep dirt and mud out of the action. As the bolt is drawn to the rear, the cover slides back with it.

**Special Note on New 7.7mm Caliber:** This weapon is fitted with a modified bolt and a shorter stock than the original. The trigger-guard has been enlarged and shaped like that on a Nambu pistol. This is a Japanese characteristic designed to enable the rifleman to fire the weapon while wearing a glove.

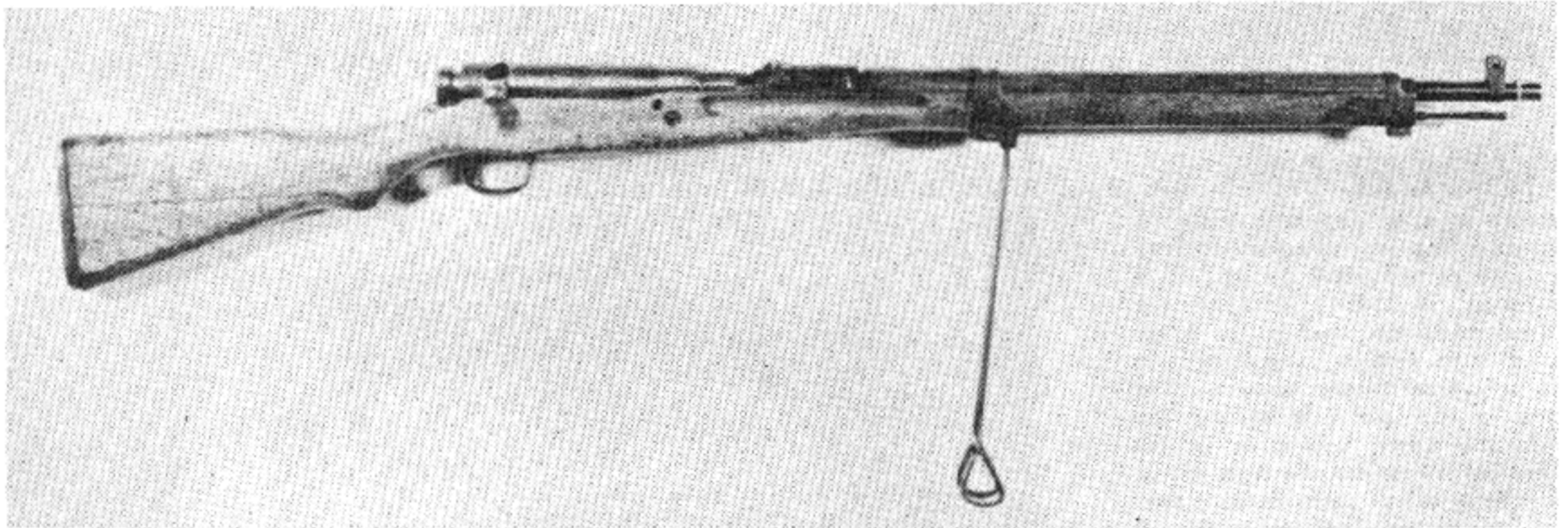

New 7.7 mm Rifle With Mount

## LOADING

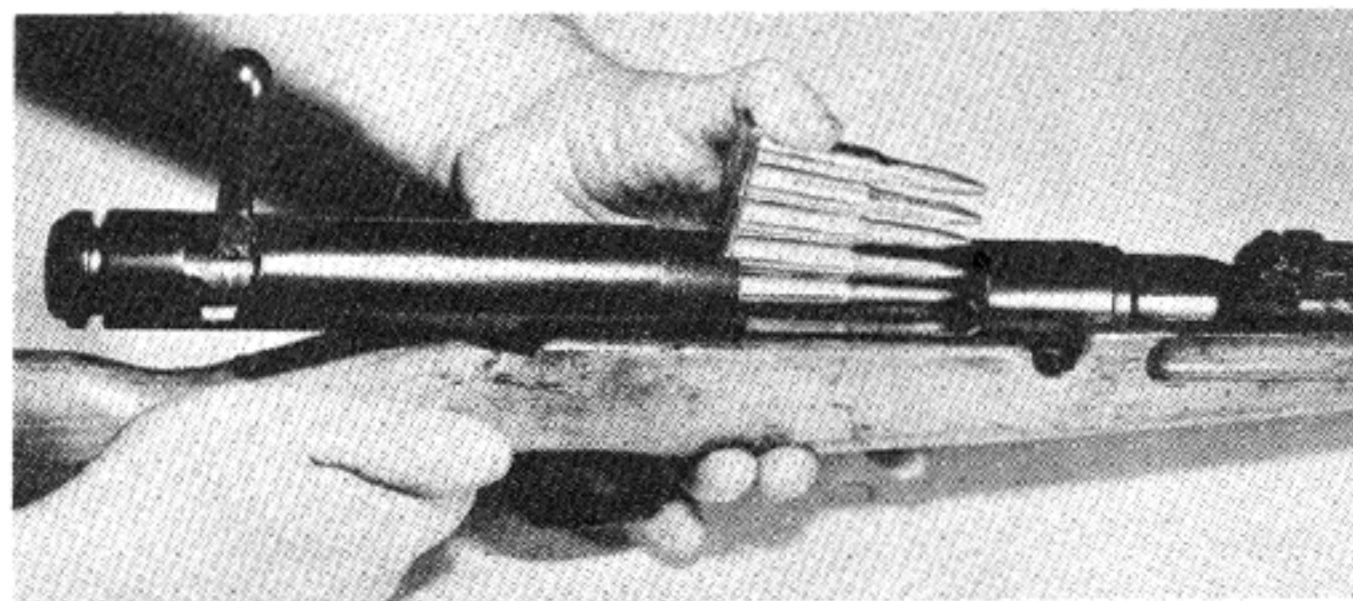

Turn bolt handle up and draw straight back to the rear. Insert loaded clip in clip guides in receiver. Press cartridges down into magazine and pull out the empty clip; pushing the bolt handle forward and turning it

down into place leaves the weapon ready for firing.

**Safety:** Push in on the head of the bolt and twist it to the left. This will lock the rifle at safe. Pushing it in and twisting it to the right will unlock it.



# JAPANESE ARISAKA 6.5-MM

## FIELD STRIPPING

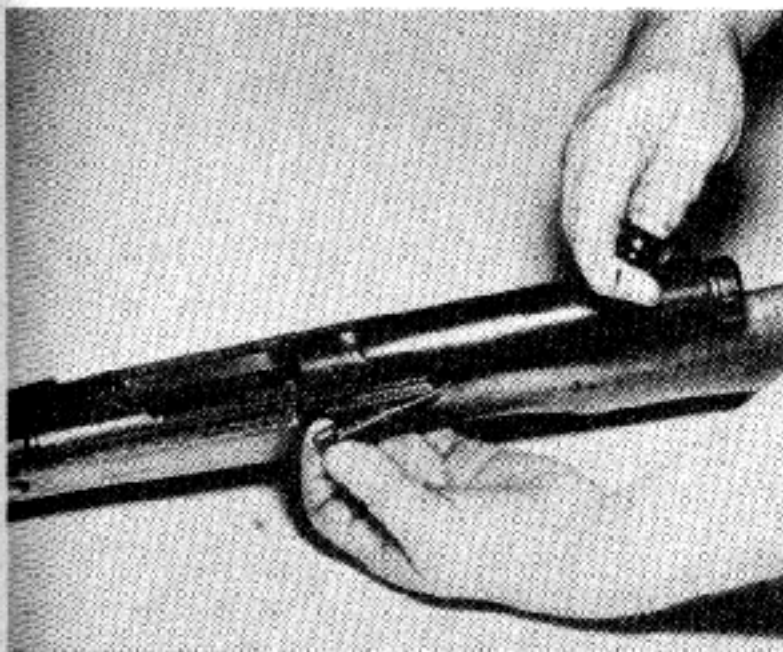

Pull out on forward end of bolt lock which is located on extreme left end of receiver. While holding this out against the spring tension, turn up the bolt handle and draw it straight back to the rear.

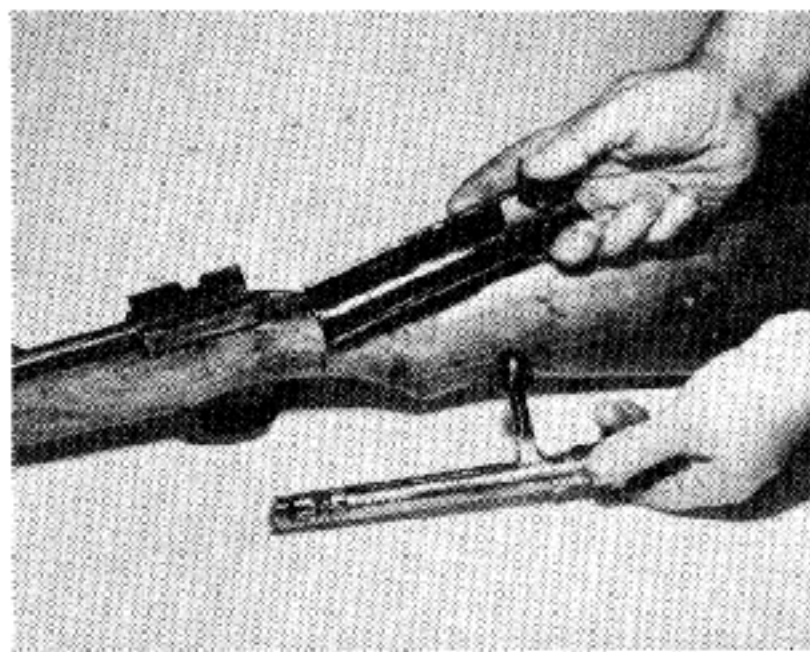

Remove the bolt cover from the bolt.

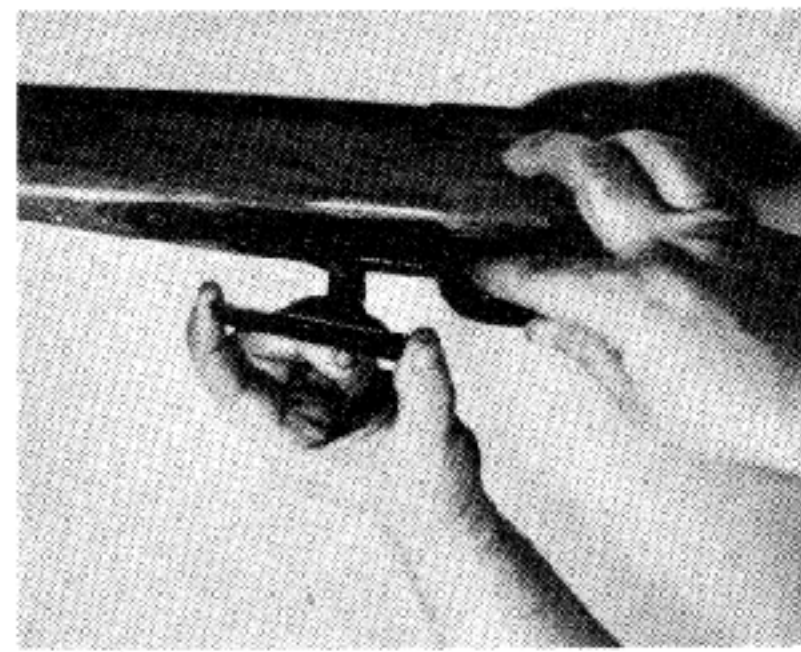

Magazine on the inside of the forward end of the trigger guard is a spring catch. Press this and the magazine spring will force the bottom plate out of the magazine. The magazine follower, spring and bottom plate may be lifted out completely. No further stripping is normally necessary.

## SPECIAL NOTE ON JAPANESE RIFLES

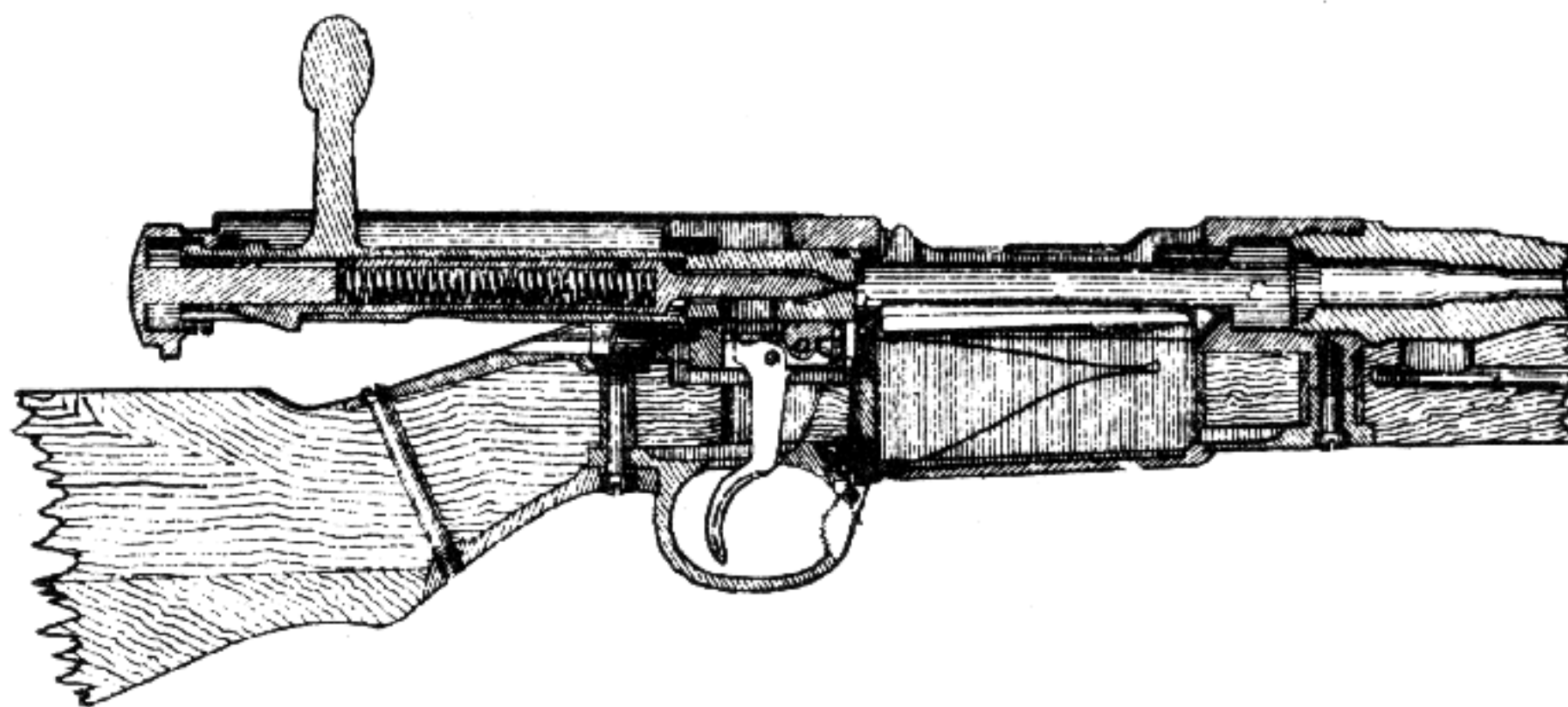

Standard Japanese Army rifles follow the general Mauser design which is the finest of the bolt action types. They are not however particularly accurate, and no provision is made in the sighting equipment for windage. They continue to use the dust cover over the bolt. While this device does unquestionably afford protection to the bolt in its closed position, it is doubtful whether the advantages thus gained are worth the disadvantages

of the heavy sliding piece of metal on the top of the bolt. The amount of play and rattle as the weapon is carried is considerable. Certainly stealthy approach while carrying such a weapon is quite a good trick. Headspace adjustment on Jap rifles is notoriously poor. The bolt cover protects the face from flash-backs from the firing chamber.



# JAPANESE NAMBU 6.5-MM 1922 MACHINE RIFLE

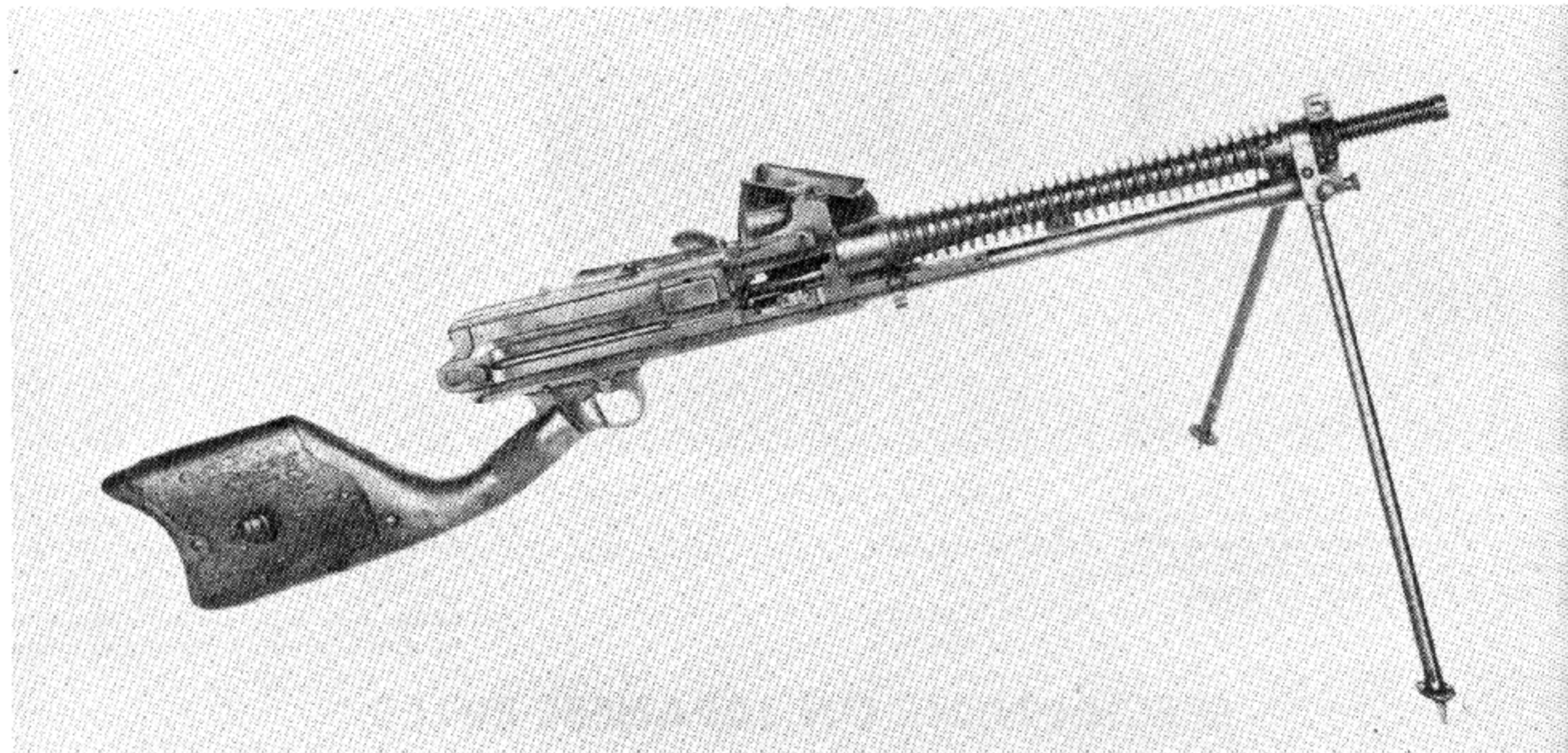

This gun is designed on the French Hotchkiss principle. It is equipped with a special feeding system, which while theoretically good, evidently did not work very well in practice; as evidenced by the fact that later patterns of the gun and of other Japanese machine rifles utilize the standard magazine or strip type of loading.

**Caliber:** 6.5mm Japanese service cartridge.

**Magazine:** A hopper. Six clips of 5-cartridges each are placed on top of each other in the magazine and a heavy spring follower is lowered down on top of them. Clips feed down and successively through the action from the left side.

**Ballistics:** Standard for Japanese service cartridge.

**Barrel Length:** About 19".

**Overall Length of Gun:** About 43".

**Weight of Gun:** About 23 lbs.

**Gun Operated By:** Gas on the general Hotchkiss principle.

**Locked:** By bolt locks thrust down behind locking lugs on sides of receiver.

**Cooled:** By air. Heavy barrel with radial fins. Weapon fires from an open bolt permitting circulation of air through barrel and breech between shots.

**Cyclic Rate of Fire:** About 500 a minute.

**Sights:** Radial back sight adjusted to 1500 meters. Adjustable front sight.

**Position of Cocking Handle:** On left side behind magazine hopper.

**Type of Fire.** Full automatic only.

**Type of Mount:** Bipod securely attached to the gun.

## LOADING AND FIRING

Lift the handle protruding through the slot in the rear end of the hopper and raise the cover attached to it as high as it will go. Place six loaded clips on top of each other in the hopper and pull the lever down until the spring cover rests on top of the cartridges.

Pull the bolt handle back to the rear until it is cocked and held in open position. This not only cocks the gun but moves the feed slide over to the right.

Pressing the trigger will now permit the bolt to go forward, loading and firing the chamber. This action will continue as long as the trigger is held back.

## FIELD STRIPPING

At the rear of the receiver is a pin which, turned down to vertical position and pulled out, permits removal of the back plate group and the recoil spring.

Draw the cocking handle to the rear and it will bring back the slide together with the bolt and the bolt locks. When the lugs on the bolt slide are properly lined up with the openings on the side of the receiver, the bolt slide may be removed from the left.

A lock is provided on the front right side of the receiver which when pulled back permits the hopper to be taken out to the left.

Directly in front of the rear sight is a stud which

when pressed down permits removing an oil pump device on the receiver, by sliding it out to the left.

The housing pin mounted between the trigger guard and the receiver, just behind the trigger, may now be punched out from right to left. This permits the trigger guard group to be slid out the rear of the receiver on guides.

On the left to the rear of the gas piston screw is a lock plate, which when removed permits the barrel housing lock to be pushed out to the front. The barrel housing may now be unscrewed from the receiver.



# JAPANESE NAMBU 6.5-MM 1922 MACHINE RIFLE

## HOW THE GUN WORKS

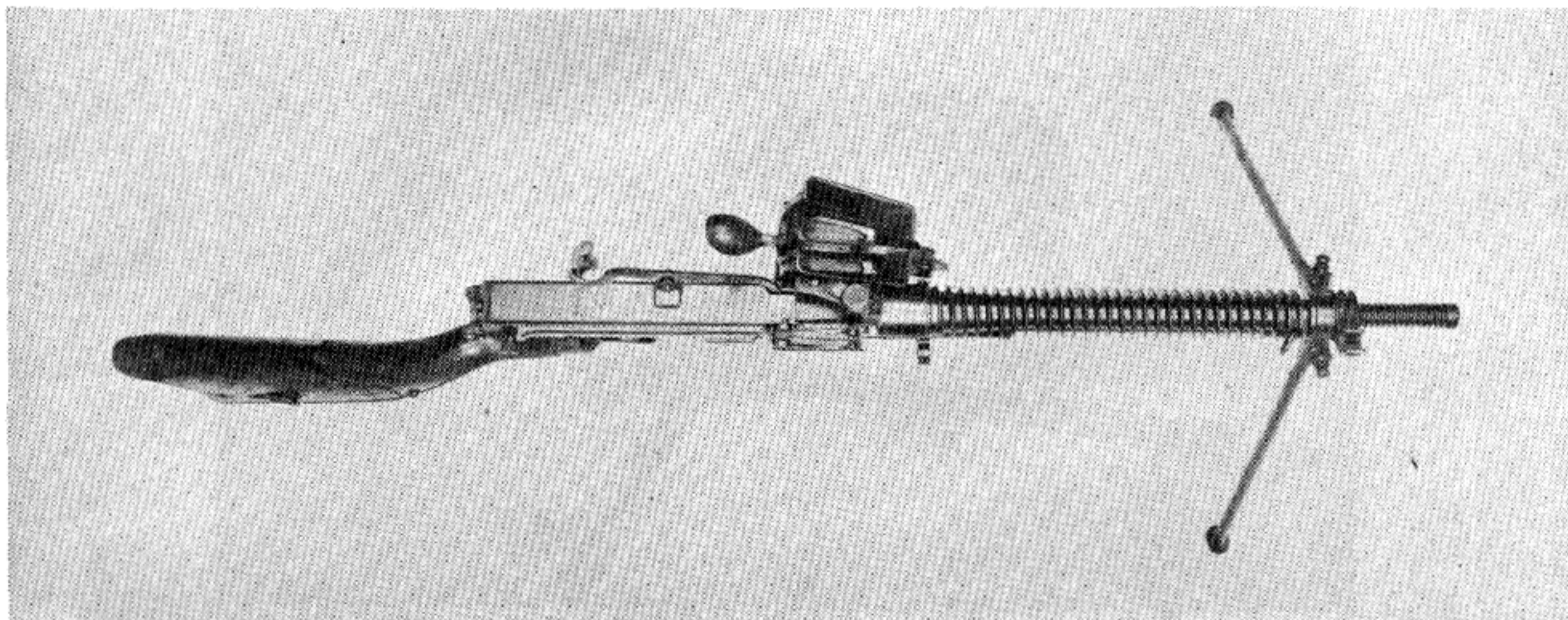

Starting with the gun loaded and cocked, the action is as follows: The trigger is pressed which moves the sear down against the tension of its spring, disengaging it from the slide. Driven forward by the recoil spring, the slide together with the bolt and bolt lock travel forward and the bolt drives the cartridge in the feedway into the chamber. The operating slide continues forward after the bolt is seated and cams a bolt lock down behind lugs on the sides of the receiver. Continuing forward it strikes the firing pin and drives it ahead to explode the cartridge.

**Return Movement of the Action:** The bullet travels down the barrel and gas passes into the gas port, thence to the cylinder below the barrel. This forces back the piston which is attached to the slide; and as they go back the slide cams the bolt lock up and the firing pin back in the face of the bolt, then draws the bolt and empty cartridge straight to the rear until the case strikes the ejector and is hurled out of the gun. The recoil spring is compressed and the bolt lock strikes against the buffer halting the rearward action.

During the rearward motion, an involved feeding mechanism cams the slide over to the right and permits racks to pull a round from a clip, position it in front of the bolt, and set it for the next feeding operation.

As cartridges feed into line, they operate an oil pump which oils each cartridge just before it is chambered; unlike better types of light machine guns, there is no period of slow extraction of the cartridge case. Hence oiling is necessary to keep the empty cartridges from sticking in the chamber under the sudden force of the jerk of the extractor.

At the front end of the gas cylinder is a device fitted with five regulator holes which can be set to increase or decrease the amount of gas striking the piston.

**Note:** This gun has long been a standard in the Japanese Army but is now rapidly being replaced by models resembling the British Bren gun, caliber 7.7mm (.303). The feed mechanism makes the gun entirely unreliable. Incidentally, this gun may be found with a tripod or an anti-aircraft mount.



# JAPANESE HOTCHKISS HEAVY MACHINE GUN

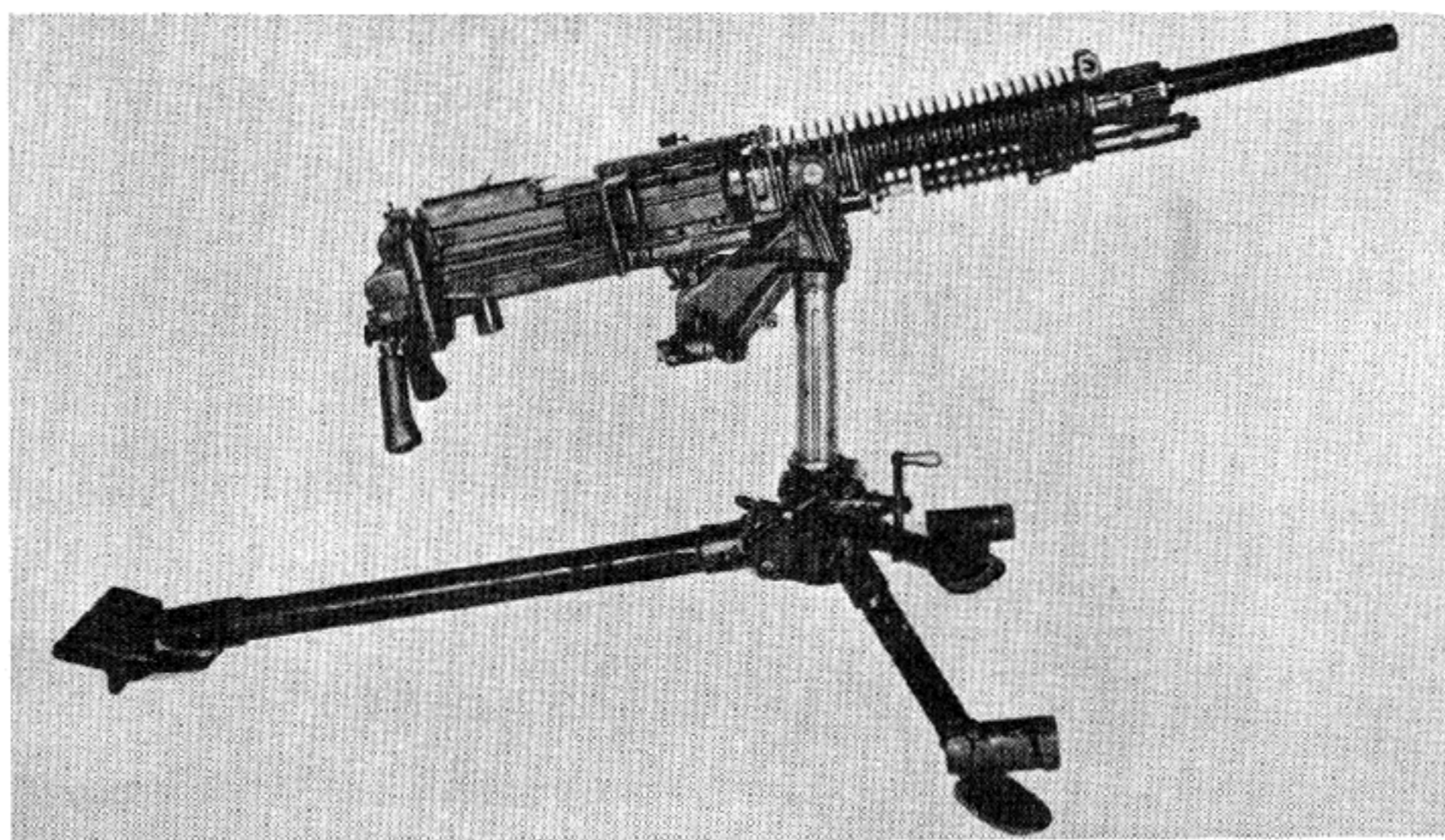

**Caliber:** Either 6.5mm or 7.7mm (.256 or .303 inch).

**Feed:** Hotchkiss type strip, 30 round capacity. Fed from the left hand side.

**Barrel Length:** About 30".

**Overall Length of Gun:** About 45".

**Weight of Gun:** 67-pounds for caliber 6.5mm, and about 62 pounds for the larger caliber.

**Gun Operated By:** Gas, Hotchkiss principle.

**Locked:** Hotchkiss principle, slide camming down the bolt lock behind locking lugs on sides of receiver.

**Cooled:** Air. Barrel partly enclosed with a sheath of heavy radial cooling rings.

**Cyclic Rate of Fire:** In caliber 6.5mm, 300 to 400 per minute, somewhat higher in the heavier caliber.

**Position of Cocking Handle:** Right side of receiver. This gun fires from an open bolt.

**Type of Fire:** Has selector device, permitting single shot or full automatic fire.

**Mounting:** Tripod. Weight about 60 pounds. Has elevating and traversing gear.

## LOADING AND FIRING

Pull the cocking handle as far as it will go to the rear. It will stay open.

Pull back the pasteboard strips (strips are factory loaded with 30-cartridges and covered with pasteboard) insert the end into the feedway until it pushes down

the holding pawl which permits the bolt and slide to jump forward a short distance, when the slide is caught and held by the sear.

Pressing in on the thumb piece of the trigger will now fire the gun.

## FIELD STRIPPING

Turn the pin in the back plate down to a vertical position and pull it out. The back plate group and heavy recoil spring may now be removed.

Pull the cocking handle back and it will bring with it the slide, bolt, and bolt lock which may be removed when the bolt slide lugs are lined up with the openings for the slide on the receiver.

Like the light Nambu, this weapon is fitted with an oil pump device. This is mounted on the left side of the receiver and may be pushed forward to raise the rear of the oil device. Removing the screw below it will now permit removal of the oil device.

There is a cover over the gas jet near the forward bottom end of the gas cylinder; removing this permits

the gas jet to be unscrewed and withdrawn from the barrel.

Now slide off the barrel nut, which lies between the barrel and the jacket just above the forward end of the gas cylinder, and give the barrel a half turn to the right. Barrel may now be pulled out and barrel sleeve withdrawn.

At the bottom of the front of the feed box is a holding pin, which when rotated one-half turn may be pulled out to permit removing the holding pawl and its spring. Line up the marks on the slide with the marks on the feed box, and drive the slide pin out to the front. The feed slide may now be moved out to the left. This completes field stripping.



# JAPANESE HOTCHKISS HEAVY MACHINE GUN

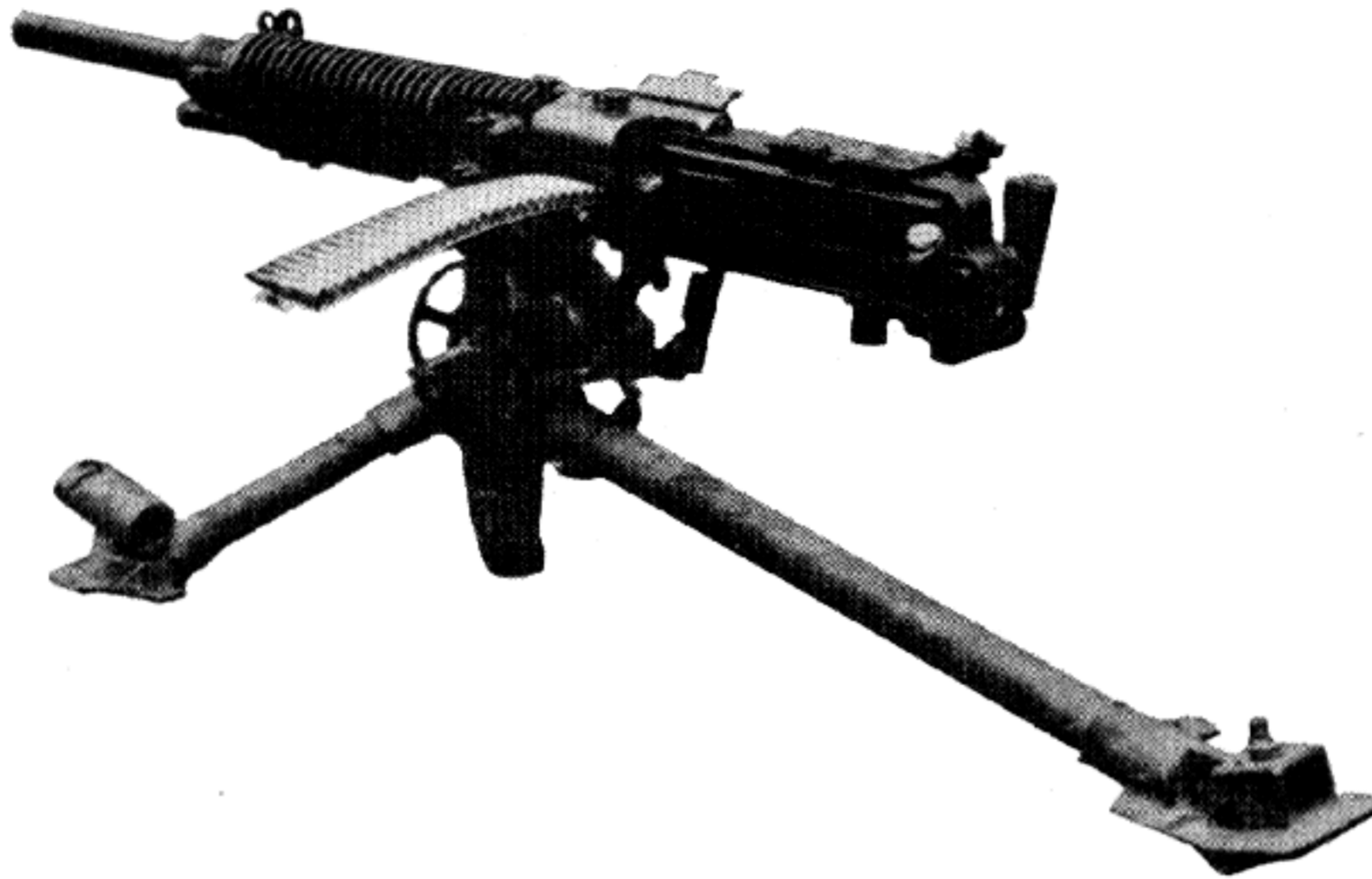

## HOW THE GUN WORKS

This gun follows the essential pattern of the French and British Hotchkiss gun. Starting with the gun loaded and cocked, the action is as follows: As the trigger is pressed, the slide is freed to be driven forward by the recoil spring. The slide carries with it the bolt and the bolt lock, and the bolt strips a cartridge from the cartridge strip and forces it ahead into the firing chamber. The slide continues to travel forward after the bolt is seated, and one of its surfaces cams the bolt lock down behind locking lugs on the inside of the receiver firmly supporting the bolt. The slide continues its forward movement, and part of it strikes the firing pin driving it forward to explode the cartridge.

**Return Movement of the Action:** As the bullet passes over the gas port, a small portion of gas passing down through the port into the cylinder drives the piston attached to the slide back to the rear. The slide cams the bolt lock up, thereby unlocking the bolt to permit it to be carried back with the rest of the recoiling

action. The bolt lock cams the firing pin back from the face of the bolt. The empty cartridge case withdrawn by the extractor in the face of the bolt, strikes the ejector and is hurled from the gun, through the ejection opening on the right side of the receiver. The recoil spring is compressed. A cam-groove on the front of the slide cams the feed slide out permitting the feed pawl to grasp the next cartridge. The cartridges as they are fed operate the oil device in the cover allowing a small amount of oil to come down on a brush which oils the cartridges as they are fed into the firing chamber. Finally the slide in its rearward motion strikes the buffer spring while the bolt lock strikes a buffer fork, and the remainder of the recoil is thus absorbed. The sear catches in its notch in the slide and holds it if the trigger has been released. If the trigger is held, the action repeats itself so long as cartridges are fed into the action.

## SPECIAL NOTE ON JAPANESE MACHINE GUNS

In the last few years the Japanese have imitated the Lewis, Vickers, Browning and Bren guns. Some of these weapons have been so carefully imitated, that they will successfully handle the British .303 cartridge. One reason for this development may be large quantities of British ammunition in possession of the Japanese.

In developing cartridges, they have made the fatal mistake of using several designs in 7.7mm (or .303"). Some weapons will take this cartridge with a rim; some when the cartridge has a semi-rim, and some when it is rimless. These cartridges are not interchangeable. The semi-rim may function in some of the rim type guns, but the parts and ammunitions supply troubles of this type of ordnance designing cannot be overestimated.

It is interesting to note that for jungle warfare, the Japanese have in use beautiful specimens of our own Browning automatic rifle manufactured by the F. N.

(Fabrique Nationale de' Armes De Guerre) of Belgium. These weapons were manufactured under a European-held Browning patent and sold by the Belgians to the Japanese. This gun varies from our own weapon only in some few details which do not affect operations. A pistol-type grip is provided near the trigger guard and a dust cover (valuable in jungle fighting, and to keep foreign matter out of the open breech) is provided on the right side of the receiver where it can be snapped on over the open breech while the gun is cocked.

The only standard pattern submachine guns so far identified in use by the Japanese are the German Steyr-Solothurn and Bergmann in caliber 7.65mm (.30 pistol-type). Other types of submachine guns in use by them represent captured equipment, or equipment manufactured in captured Chinese arsenals. No distinctively Japanese design has been attempted in this form of weapon.



# JAPANESE 6.5-MM 96 LIGHT MACHINE GUN (1936 AND 1939)



This weapon bears a great many resemblances to the British Bren Gun. While the original calibre was 6.5mm, this gun is also being made in 7.7mm caliber in rim, semi-rim, and rimless type cartridges. The original gun design was borrowed from the French Hotchkiss.

**Caliber:** 6.5mm Japanese Service cartridge, or 7.7mm.  
**Magazine:** Arc-shaped, mounted on top of gun as for Bren gun.

**Capacity:** 30 rounds.

**Ballistics:** Standard for these cartridges.

**Barrel Length:** About 22".

**Barrel Removal:** Similar to Bren gun. barrel catch on receiver in front of magazine.

**Weight of Gun:** About 20 pounds.

**Overall Length of Gun:** About 42".

**Sights:** Rear sight drum as for Bren gun.

**Gun Operated By:** Gas, Hotchkiss principle.

**Locked:** Similar to Bren gun.

**Cooled:** Air. Very heavy barrel with outside cooling grooves.

**Cyclic Rate of Fire:** 550 to 600 a minute.

**Position of Cocking Handle:** Left side of receiver below line of magazine.

**Safety:** On left side of pistol grip ahead of trigger.

**Mounting:** Bipod permanently attached about 6" from the muzzle. This may be folded. A bayonet attachment is also provided.

**Type of Fire:** Has change lever to permit firing single shot or full automatic fire.

**Special Feature:** This gun is fitted with a mount for a telescope.

## LOADING AND FIRING

**Loading and Firing:** Load magazine as for Bren gun. Insert magazine as for Bren. Magazine catch is at rear of magazine; pushed forward it releases the magazine.

Pull back cocking handle on left side as far as it will go to retract bolt, then thrust cocking handle forward. Selector device may be set for single or automatic fire. Weapon is now ready to fire.

**Field Stripping:** Stripping this gun is essentially the same as for a Bren gun. When the action is cocked, the barrel catch on top of the receiver ahead of the mouth of the magazine opening may be unlocked to permit turning the barrel carrying handle and pushing it forward and removing it from the receiver.

Removing the receiver locking pin at the extreme rear of the receiver behind the rear sight drum (as in the Bren gun) facilitates further stripping.

**How the Gun Works:** A study of the Bren and Hotchkiss type will effectively cover the general operation of this gun.

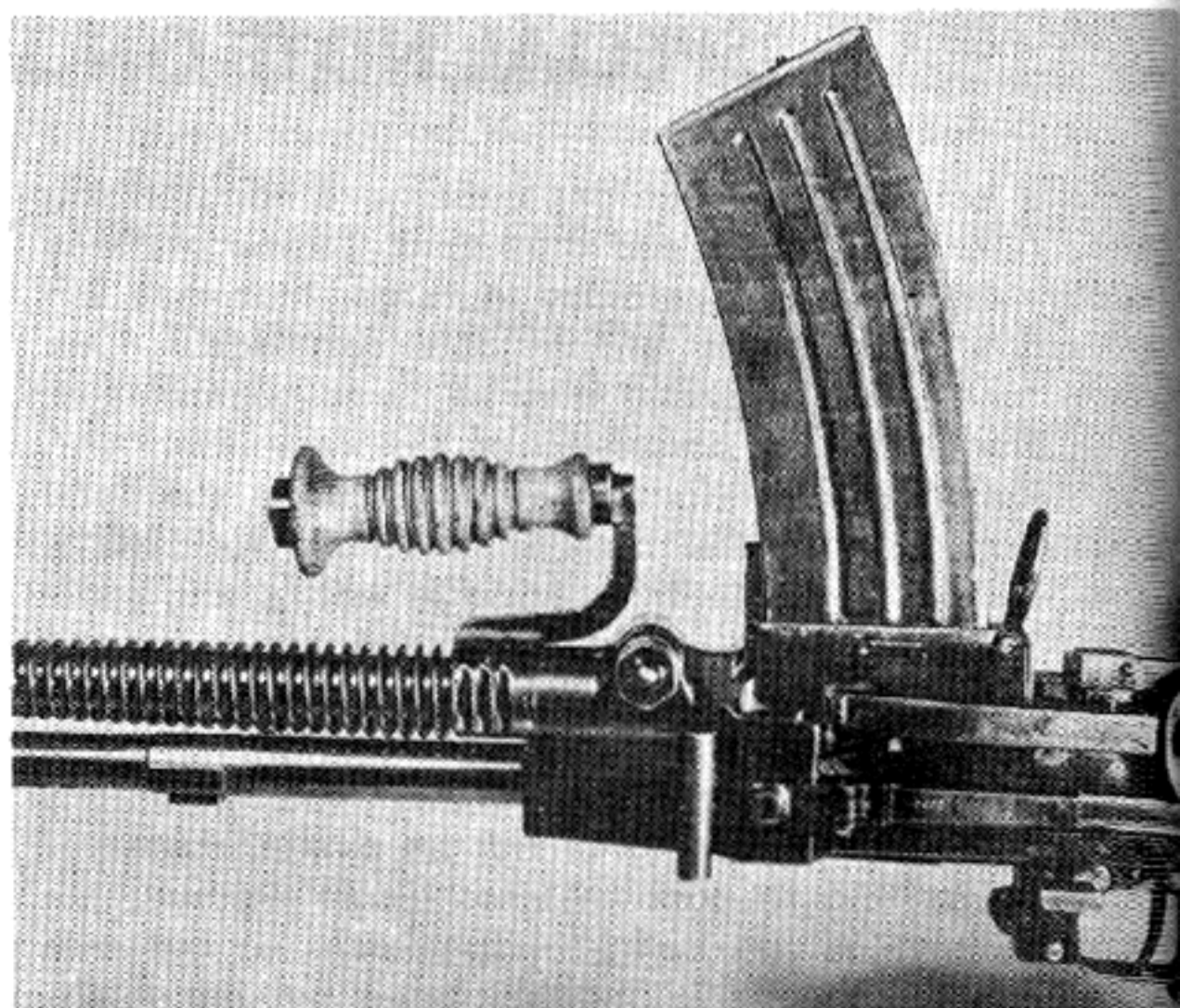



# MEXICAN MENDOZA 7-MM LIGHT MACHINE GUN

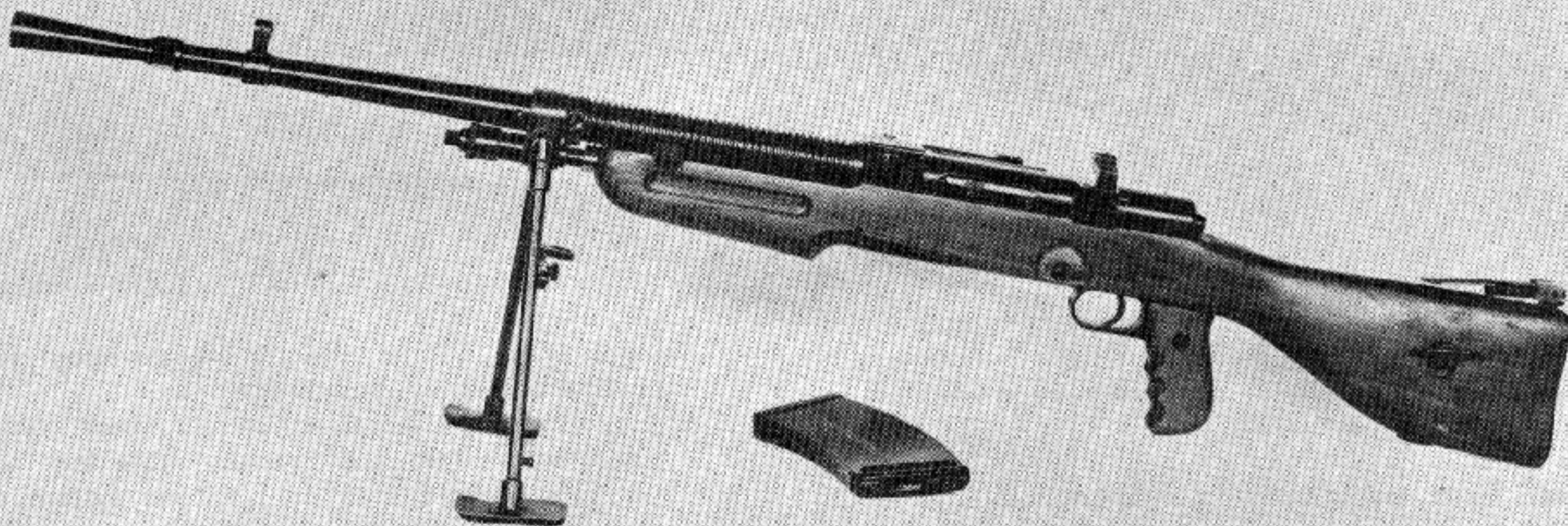

**Caliber:** 7mm Mexican Army.

**Magazine:** Box type, on top of receiver as in the Bren gun.

**Capacity:** 20 rounds.

**Overall Length:** 46".

**Weight:** 18½ lbs.

**Gun Operated By:** Gas. Gas escaping through hole in under side of barrel through gas vent into cylinder drives piston back as in the case of the Hotchkiss guns.

**Locked:** By turning bolt as in Lewis. As piston is driven to the rear by escaping gas, bolt is turned out of locking position by a cam arm operating in a curve in the body of the bolt.

**Cooled:** Air cooled. Has radial fins on rear of barrel. Bolt stays open between shots.

**Cyclic Rate of Fire:** 500 rounds per minute.

**Position of Cocking Handle:** On left side of gun near the front of the fore-end. It is a small bar which when pulled directly to the rear cocks the gun.

**Type of Fire:** Full or semi-automatic. Change lever on left side of gun, above and in front of the trigger guard.

**Flash Hider:** Gun is fitted with a conventional bell-mouth type flash hider extending from the barrel.

**Mounted:** Simple bipod mount is normally used. Special anti-aircraft and tank mounts are also provided.

While this gun is not in wide production, it is worthy of attention because of the remarkably fine design and the excellence of manufacture. It is the official light machine gun of the Mexican army and was invented by the famous Mexican arms authority, after whom it is named. Like the Bren gun, the barrel in the Mendoza may be removed easily. The barrel lock is on the right side of the receiver. When it is pulled out it disengages locking lugs from slots in the barrel, permitting the barrel to be pulled forward from the front as in the case of the Bren.

The gun is fitted with an adjustable gas port near the center of the barrel. The gas cylinder itself is short and it has an open end into which the piston enters when the action is in full forward position. As the piston is thrust back by the escaping gas on the barrel, it revolves the bolt much as in the Lewis gun, unlocking the weapon and permitting the bolt to travel straight to the rear, with the piston. This action also compresses the recoil spring.

The gun has a pistol grip notched for the finger and has a butt-strap similar to that of the Bren gun.



# RUSSIAN MOISIN 7.65-MM RIFLE

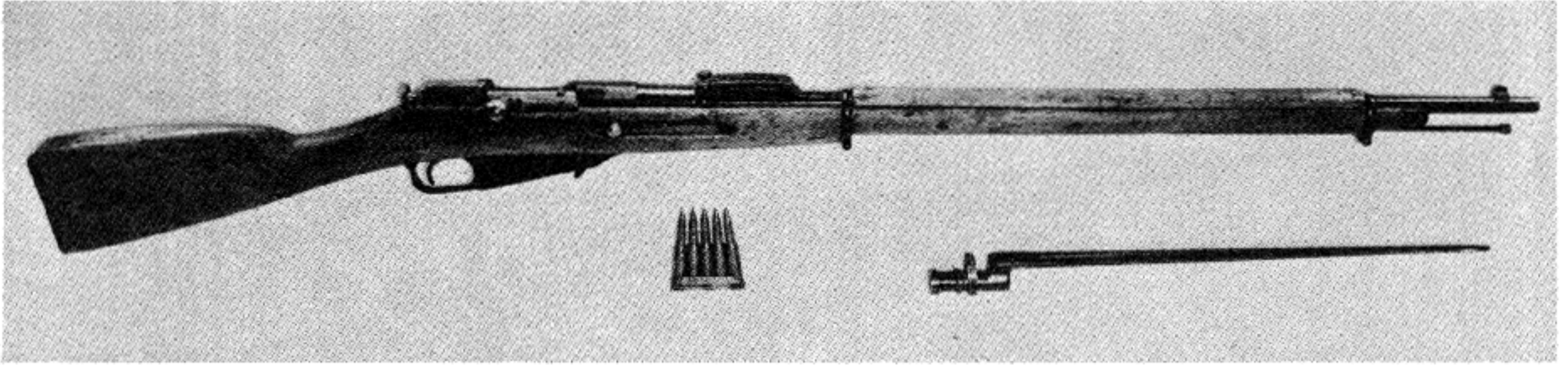

While this is the basic rifle of the Russian Army, other and more modern types—as well as more ancient ones—are in use. This weapon may eventually be supplanted by the new Russian automatic rifle.

**Caliber:** 7.65mm Russian.

**Magazine:** Fixed vertical box as in Springfield.

**Barrel Length:** 31.5".

**Overall Length of Rifle:** 4'-3 4/5" (with bayonet about

17" longer).

**Weight:** 8 lbs. 15 ozs. Bayonet weighs about 13 ozs.

**Magazine Capacity:** 5 cartridges.

**Sights:** Barleycorn front and V-rear. Rear sight adjustable from 400 to 2700 paces. Note that this does not follow the English or European system of sight estimation.

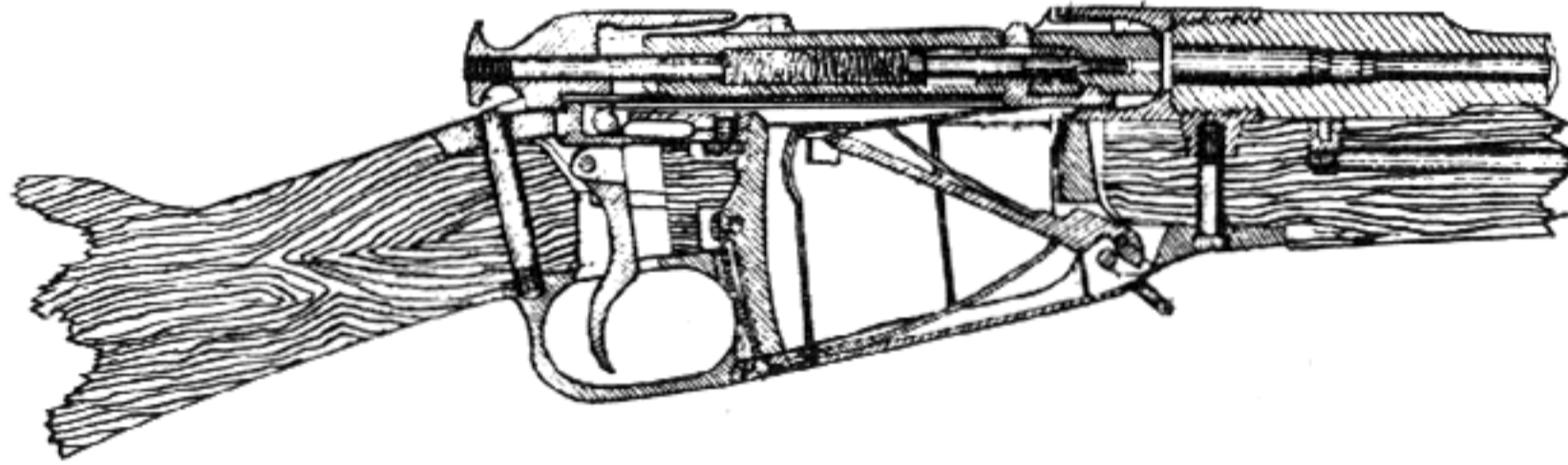

**Loading and Firing:** Bolt is lifted up and drawn back as far as it will go. Cartridges are then loaded down into the box of the magazine in normal fashion. Pushing bolt forward loads the firing chamber, turning the handle down locks the weapon. Pressing the trigger will now fire the rifle.

**Special Note on This Rifle.** This rifle is designed on the Nagant system. Its bolt is a very complicated affair. It has a separate bolt head revolving with the bolt and bearing two lugs. The bolt head and bolt are held together by a connecting bar beneath them which acts as a guide to the cocking piece. It also serves to hold the bolt in the receiver. When the weapon is closed, the bolt lugs are horizontal instead of being one above the other as in the Mauser and Mannlicher systems. The striker is a single piece actuated by a mainspring.

**Safety:** Pulling out on the cocking piece and turning it to the left prevents the weapon from being fired or the bolt being opened.

**Magazine:** The box magazine is made in one piece with the trigger guard. It is fitted with a special inter-

rupter to prevent more than one cartridge at a time coming up into the feedway. A projection on the end of this interrupter acts as an ejector.

**Trigger:** The first pull on the trigger releases it. A tooth at top of trigger projects into the boltway and takes the place of the ordinary sear.

**Mainspring:** The first part of compression occurs when the cocking-piece nose works in a cam recess on the nose end when the bolt handle is pulled to the rear; the compression is completed as the bolt handle is turned into its locking seat by the action of the lugs on the sloped entrance of the seat.

**Special Note:** This rifle is of 1900 design. It is not to be confused with the really superb firearms designed and manufactured by the Russians in the last 10 years.



# RUSSIAN MAXIM 7.65-MM MACHINE GUN



## This is the standard heavy Machine Gun of the Russian Army

**Caliber:** 7.65mm Russian.  
**Feed:** Fabric belt holding 250 rounds.  
**Barrel Length:** 28 $\frac{1}{4}$ ".  
**Weight of Gun:** 58 pounds.  
**Mounting:** Tripod with detachable wheels.  
**Weight of Tripod:** 70 pounds.  
**Sights:** Barleycorn front and V-rear. Elevation from 400 to 2,000 paces.  
**Gun Operated By:** Recoil.  
**Locked:** Standard Maxim system, formation of a toggle joint.  
**Cooled:** Water. Has water jacket around barrel to absorb heat.  
**Cyclic Rate of Fire:** About 500 per minute.  
**Type of Fire:** Full automatic only.  
**Special Features:** The only unusual features in this gun

are the mountings employed. The wheeled mount permits rather easy manoeuvring for such a heavy gun, and makes unnecessary the constant mounting and dismounting necessary to move a machine gun of this general type rapidly.

**Loading, Firing, Stripping and Functioning:** The descriptions given for the German Maxim gun and the British Vickers gun cover all the features of the Russian Maxim. All are basically the same. The Russian weapon follows the German in that the crank handle is rotated forward rather than pulled back as in the Vickers.

While light machine guns have tended to supplant the heavy and medium type in field work, any study of Russian news reels will establish the very wide use to which the Russians employ this heavy type of gun on wheels with and without bullet shield.

## OTHER RUSSIAN MACHINE GUNS

The Russians employ practically all types of United States and British equipment. They also make the fullest use of all captured equipment.

The most outstanding characteristic of Russian designers is their willingness to accept any superior weapons they encounter in the course of battle, and the ingenuity which they demonstrate in altering and improving them for their own special uses.

Russian light ordnance is in a constant state of flux. The German system of trying out suggestions and improvements under actual battle conditions without waiting for overly long preliminary proving tests, is characteristic also of the Russian Army.

Some of the Russian light machine equipment was extensively used in the Spanish Civil War (notably the Degtyarov light machine gun). Except for the information obtainable from Americans and Englishmen who fought in Spain, very little information is to be obtained on Russian equipment except when pieces are seized from Germans who have captured them and used them for their own purposes.

Heavy models of the Degtyarov are widely used for tank and antiaircraft guns. These as well as Maxims are often mounted in pairs, or in units of four, six or even eight guns firing as a unit.



# RUSSIAN DEGTYAROV 7.62 1938 LIGHT MACHINE GUN



This weapon is a truly outstanding piece of ordnance design. No other weapon manufactured anywhere in the world excels it for simplicity, reliability or general design. It saw considerable service in the Spanish Civil War. It is the standard light machine gun of the Russian Army.

**Caliber:** 7.62mm Russian service cartridge.

**Magazine:** Pan type, mounted on top of receiver.

**Capacity:** 47 cartridges.

**Ballistics:** Standard for Russian cartridges.

**Barrel Length:** About 24".

**Overall Length of Gun:** About 50".

**Weight:** 18½ pounds.

**Sights:** Open type.

**Rear "U" Sight:** Adjustable for elevation.

**Accurate Range:** Normal for light machine gun.

**Gun Operated By:** Gas. As bullet passes over gas hole

in barrel, gas expands through the port and strikes the gas piston which carries back the slide, spring and recoiling parts a short distance, and unlocks the bolt in its rearward motion.

**Locked:** By an entirely unique lock, fitted with bolt locks which are cammed into recesses in the sides of the receiver as the cartridges feed in.

**Cooled:** Air cooled. Bolt stays back with action open between shots, permitting circulation of air down barrel.

**Barrel Removal:** When barrel overheats, it can be removed from gun and replaced by spare barrel in a few seconds.

**Position of Cocking Handle:** On right side of receiver. Pulling it back cocks the weapon ready for firing.

**Type of Fire:** Automatic only. Weapon will fire as long as trigger is held in rearward position.

## LOADING AND FIRING

**The Magazine:** This type drum differs radically from the Lewis type. The inner center rotates, while the outer rim is fastened securely to the gun. The cartridges lie in single line around the inside of the pan.

**To prepare for firing:** Mount a loaded magazine on the post on top of the receiver and press firmly down until it is caught by the magazine catch. (The magazine

catch is mounted in the front end of the rear sight base.) Now pull back the cocking handle as far as it will go. It will stay open. Pressing the trigger will now fire the gun. Full automatic fire will ensue as long as the trigger is held down and there are any cartridges in the magazine.

## FIELD STRIPPING

**To remove the Barrel:** Pull the cocking handle to the rear to cock the weapon. The barrel locking stud is on the left side near the front of the receiver. Press this stud in, which will release the barrel, then twist the barrel up one quarter turn to the right. Now slide the barrel straight forward out of the receiver.

Press the trigger and ease the cocking handle forward. Pull out the bolt at the rear of the trigger guard, which leaves the stock and trigger guard free to be turned until the rear of the trigger guard is clear of the receiver. Pull the stock and trigger guard assembly back and out of the receiver.

A small sleeve fits behind the recoil spring at the rear

of the gas cylinder tube. Press this forward and twist it to the left; this will free the bolt together with the slide and the gas piston attached to it to be withdrawn at the rear of the receiver.

The bolt may now be lifted from the top of the slide. The firing pin may now be slid out of the rear of the bolt. The bolt locks on each side of the bolt may now be lifted out; and the front of the extractor spring raised and pulled forward to permit removal of it and the extractor.

This completes field stripping. Assembling the gun is equally simple and merely calls for reversing the stripping procedure.



# RUSSIAN DEGTYAROV 7.62 1938 LIGHT MACHINE GUN

## HOW THE DEGTYAROV GUN WORKS

Starting with a loaded magazine on the post, and the gun cocked the action is as follows:

Pressing the trigger rotates the sear down and out of its notch in the bottom of the slide. (The slide carries the bolt mounted on top of it, and the gas piston rod mounted in its forward face.) The moving parts are now carried forward by the action of the recoil spring which is compressed around the gas piston rod. As the bolt moves forward a feed rib on top of it strips a cartridge from the magazine and drives it ahead into the firing chamber.

The bolt chambers the cartridge and brings the ex-

tractor over the cannellure of the cartridge case. The bolt is now fully home.

The slide still continues forward, pulling forward with it the firing pin inside the bolt. In this movement the firing pin is entirely divorced from the bolt; and it is so shaped that it cams out a lock on each side of the bolt, pushing these locks into recesses on the sides of the receiver. This firmly locks the bolt. The slide continuing to go forward, drives the firing pin forward through its opening in the bolt and strikes the cartridge in the firing chamber. The bullet starts down the barrel.

## RETURN MOVEMENT OF THE ACTION

When the bullet passes over the gas port, a small quantity of gas passes through this port in the bottom of the barrel, striking the gas piston a violent blow. The piston will go back a short distance together with the slide; allowing time for the bullet to leave the barrel and the pressure in the breech to drop.

At that point, the cam surfaces on the firing pin force against the sides of the two bolt locks at the forward end and cam the rear ends out of their locking slots in the side of the receiver. From that point on the bolt moves back with the rest of the mechanism. The

empty cartridge case is extracted from the chamber, strikes against the ejector and is hurled out of the gun. Meanwhile, after the gas piston has recoiled an inch or two, it emerges from the cylinder on the barrel, allowing the excess gas to escape. The magazine spring brings a cartridge into line.

This forward and rearward action will be continued as long as the trigger is held. Releasing the trigger enables the sear spring to force the sear up and catch in its notch in the lower side of the slide, thus holding the action open.



# NOTES ON RUSSIAN SMALL ARMS

## SUBMACHINE GUNS



The principal Russian submachine gun is the model PPSH-41. This is an amazingly simple weapon and is really an adaptation of an early model of the German Bergmann. The gun hinges at the end of the wooden fore-end, permitting the barrel, barrel casing and receiver to be tipped up out of the frame, exposing all working parts for cleaning and examination.

It is normally fitted with a drum magazine of the general type used in the American Thompson gun. The magazine capacity is 72-cartridges. The caliber is

7.63mm Mauser type.

The gun weighs 10 1/10th pounds, has a barrel 10 1/4" long and has an overall length of about 31". The stock is **not** detachable. The weapon is fitted with a front blade sight and a leaf-type rear sight. Effective range is listed as 300 yards and maximum range as 800. The cyclic rate of fire is about 600 rounds per minute. Cocking handle is on right side of gun. Some models are fitted with a change-lever button permitting full or semi-automatic fire.

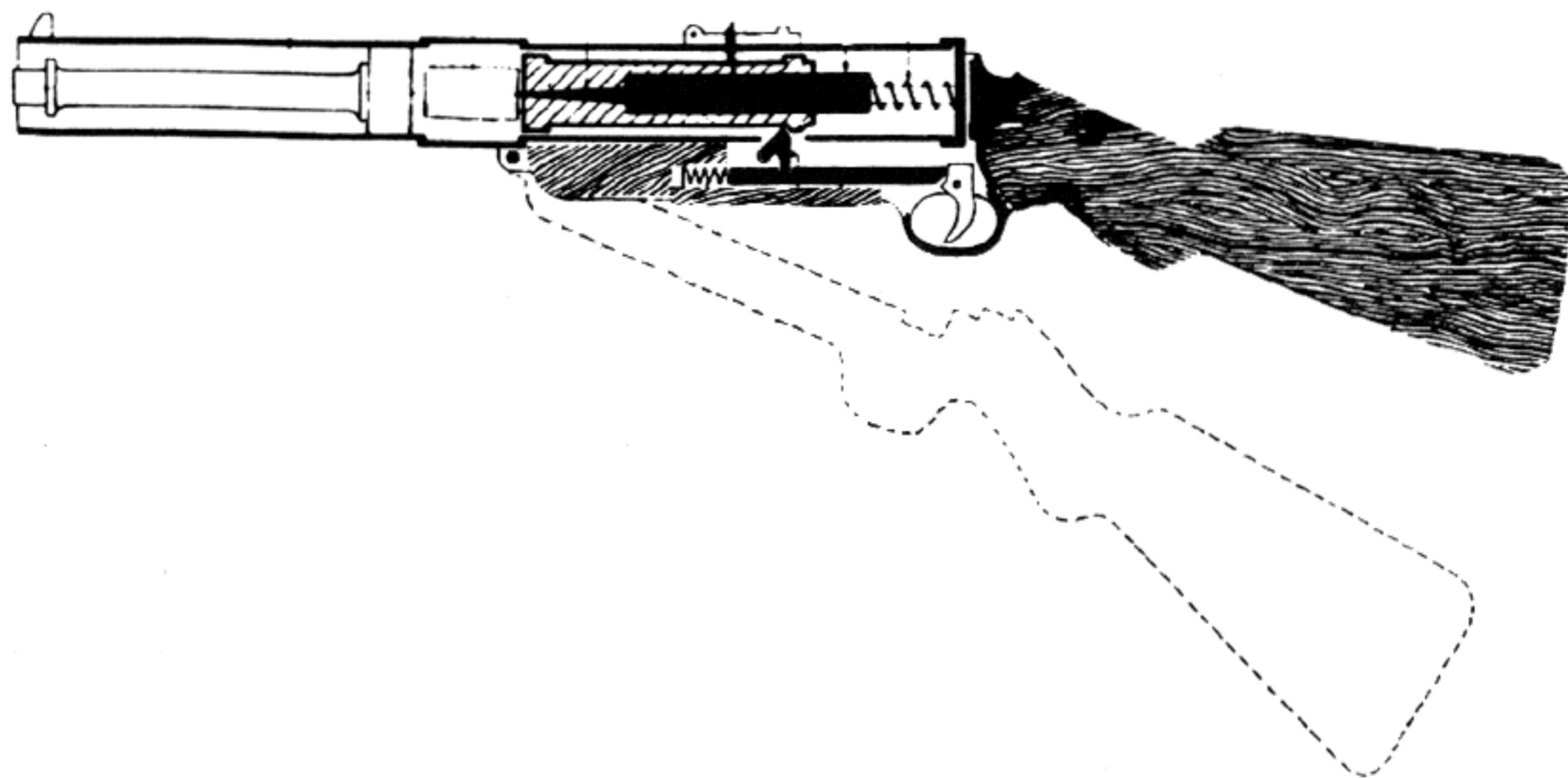
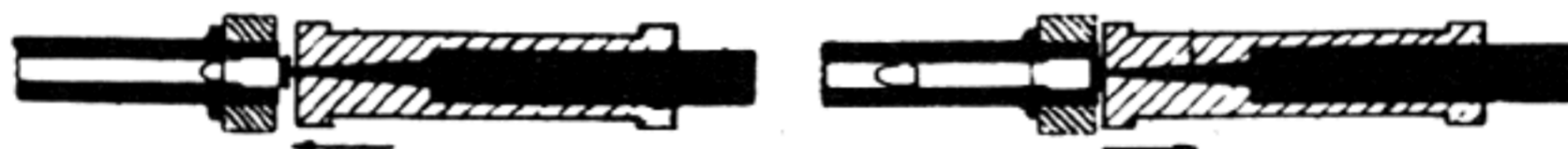

Working Drawing Showing Details of Russian Submachine Gun, Bergmann Type

Large quantities of Suomi type as well as German Bergmann and Schmeisser type 9mm, and American Thompson caliber .45 submachine weapons are also in wide use in Russia.

The submachine gun has come to be a very important

weapon in Russian tactics. The Russians have even gone beyond the Germans in issuing these weapons to entire battalions. The enormous fire power thus developed appears to be a tremendous factor in offensive fighting and at close ranges.



# NOTES ON RUSSIAN SMALL ARMS

Whatever the reason, no recent models of Russian small arms have ever been sent to the United States. All the information available on these weapons comes from foreign magazines, German hand books, from British sources whenever Russian weapons captured by

the Germans have been recaptured from them by the British, from Spanish sources where these weapons in their formative stages were tested out during the Spanish Revolution, and from a study of Russian news reels.

## REVOLVERS AND PISTOLS

The latest design in Russian pistols, is the Tokarev Automatic Pistol, \*C. C. G. P. Photographs of this weapon show it to very closely resemble our own Colt Pocket Automatic Pistol Caliber .380 except that it is somewhat larger and is equipped with a push-button magazine release as in the case of our own Army automatic pistol, and that the slide stays open when the last shot has been fired. The barrel length is somewhat over 4 1/2", the overall length about 7 3/4". The magazine holds 8-cartridges. This pistol is listed as being fitted with the "Colt" locking system. As it is chambered to take the 7.63mm Mauser pistol cartridge, which has a normal muzzle velocity of over 1400 feet per second and a striking energy of over 400 foot pounds, this hammerless Russian pistol may employ the so-called parallel-ruler locking system of our own .45 Colt automatic; or may use a reduced charge cartridge.

The Colt .380 automatic, like its offspring the Browning 9mm long is a simple blow-back weapon which is kept closed at the moment of firing only by the weight of the moving parts and the heavy recoil spring. This action could not stand the shock of a powerful cartridge like the 7.63mm Mauser unless it is fitted with additional heavy buffer and recoil springs, like the German Dreyse or the Italian 1915 model Beretta; or unless the cartridge is short-loaded.

In passing it may be noted that the 7.63mm Mauser

pistol is a favorite in the Siberian area and that most of the new Russian submachine guns are chambered to take this cartridge.

The Nagant revolver of 7.5mm caliber is also in use in Russia. This is a swing-out cylinder revolver. It is fitted with a very unusual gas lock. The cartridge resembles the American .32-20, but the cartridge case extends slightly **beyond the end of the bullet**. The front ends of the chambers are tapered, as is the rear end of the barrel. When the revolver is cocked, the cylinder not only revolves but is also **pushed forward** against the barrel, thus providing a more effective gas seal at the juncture of the barrel and the chamber than is theoretically customary in revolvers. The bullet weighs 108 grains and may be either lead or full-metal case. Velocity is in the neighborhood of 726 feet per second and striking energy about 125 foot-pounds.

In actual practice, the gap between chamber and barrel in the Standard United States Colt or Smith & Wesson revolver is so small that the escape of gas as the cartridge is fired is actually likely to be less than in the revolver of the Nagant type in which the original machining is not nearly so accurate.

All types of United States, German and British revolvers and pistols will be encountered in Russia. However, the Tokarev and the Nagant are the official weapons most likely to be found in the first line forces.

## RIFLES

The Russian gas operated semi-automatic rifle appears to be a weapon of very excellent design. Like our own Garand, it has been altered and improved several times since originally issued. It was developed directly from a Czech rifle made at the Brno Works. Originally issued under the name "Simonov" rifle in 1936, it was fitted with a detachable 15-round magazine. In 1938 an improved model was issued. The newest version is known as "Tokarev" model 1940.

The present rifle is gas operated, as is our Garand, and uses the standard Russian 7.62mm rifle cartridge. It weighs about 10 8/10 pounds with the magazine and the bayonet. The barrel is about 24 1/2" long and the overall length with bayonet is about 51 1/2". The rifle itself measures somewhat over 40", in overall length. A leaf rear sight is graduated from 100 to 1500 meters in 100 meter steps. Some models are equipped with flash hiders. The magazine is a detachable 10-shot box inserted from the bottom, with a rising follower which

holds the bolt open when the last shot has been fired. Some models of this weapon are fitted with a change-lever permitting full automatic fire. The normal rifle however, is semi-automatic as in the case of our own Garand.

This rifle is very widely used by snipers when fitted with a telescope. While this would seem to indicate an unusual degree of accuracy in a rifle of this type, it should be remembered that the Russian concept of sniping differs very widely from that of the United States and the British armies. Russian sniping is apparently done at very much closer ranges than is customary with our forces. The telescope would seem to be unnecessary as sight equipment at many of the ranges at which it is used, judged by U. S. shooting standards.

The wide use of these semi-automatic rifles seems to indicate that the Russians are following in our footsteps and replacing bolt action rifles as rapidly as possible.



# NOTES ON RUSSIAN SMALL ARMS

## LIGHT MACHINE GUNS

The Degtyarov light machine gun is one of the most important weapons developed by the Russians. It is treated in considerable detail separately in this book; since its design and effectiveness places it in the ranks of the finest small mobile weapons ever developed.

The Federov light machine gun has been kept as a guard-duty weapon. This gun, which is recoil operated and fitted with a 25 round box magazine, did not perform very well in service, particularly in its trial stages

in the Spanish Civil War. It is an air cooled weapon with a change-lever permitting semi or full automatic fire, and has a cyclic rate of about 600 rounds per minute. Without magazine it weighs about 9 9/10th pounds.

The Federov is noteworthy for just one thing: It was issued in two calibers. 7.62mm Standard Russian and a 6.5mm which will fire Japanese cartridges. The gun is no longer manufactured.

## HEAVY MACHINE GUN

The Maxim gun used by the Russians very closely resembles the German version. This weapon is utilized very generally through the Russian forces. It is normally mounted on a 2-wheel mount fitted with a shield and is moved forward rapidly during offensive. Variations of this Maxim are commonly seen in 2, 3, 4 and even 8 multiple mounts where it is employed for antiaircraft

fire. It is also tripod mounted.

Heavy models of the Degtyarov are in general use for antiaircraft, aircraft and tank guns. All follow in general principle the basic Degtyarov pattern.

In addition to the above, all forms of United States, British and German weapons are employed by the Russian forces.



# SPANISH ASTRA 9-MM LONG 400 AUTOMATIC

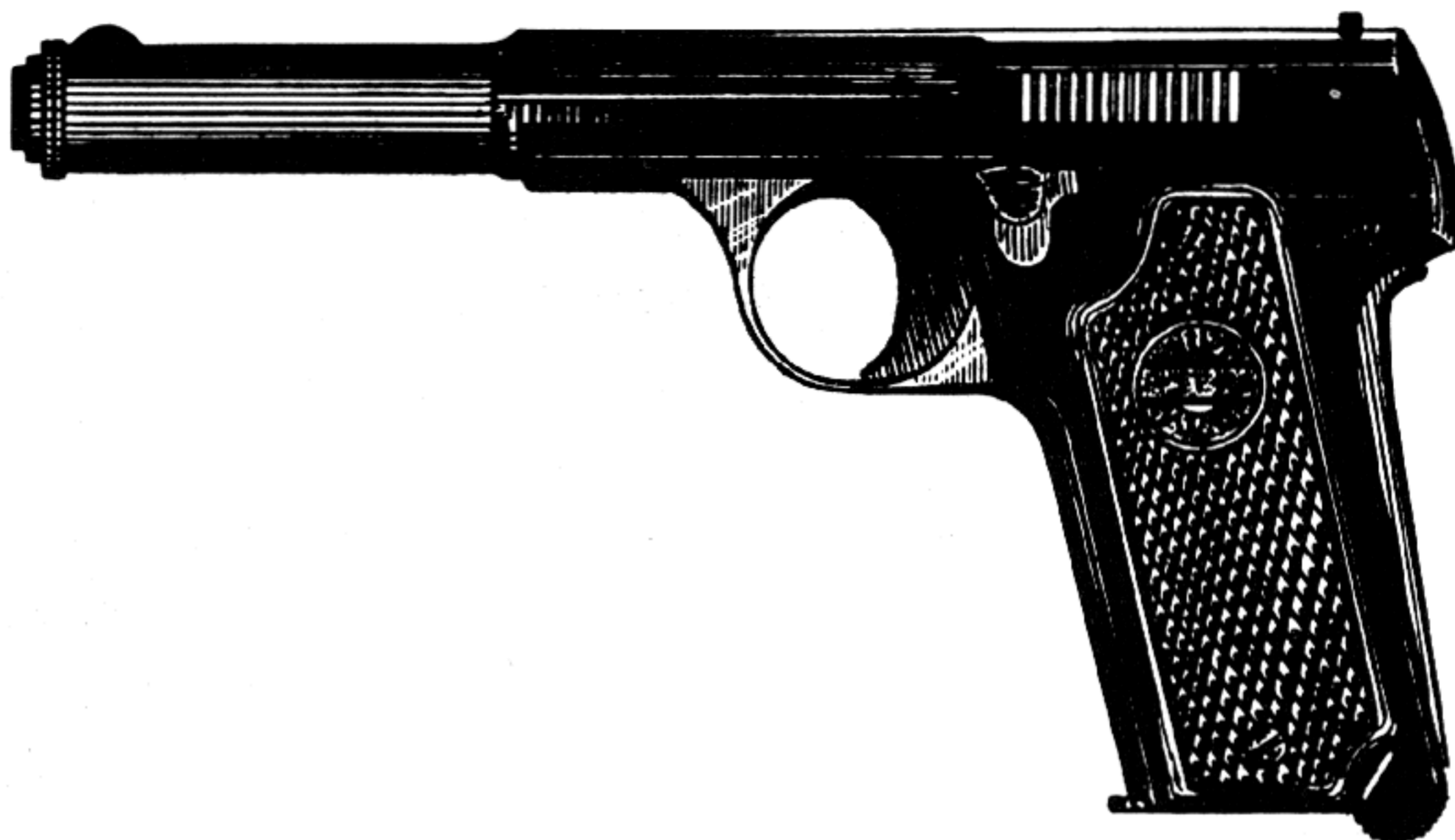

This is an Official Spanish Pistol, hammerless, straight blow back weapon with a very heavy recoil spring. It is equipped with a grip safety similar to the Colt and a thumb safety on the left side of the pistol. The magazine release catch is in the butt in the rear.

**Barrel Length:** 5 $\frac{1}{2}$ ". Pistol is 8 $\frac{3}{4}$ " in overall length.

**Magazine Capacity:** 7 cartridges.

The cartridge used in this pistol is known in Spain as the 9mm Bergmann type. It is practically the same as the Colt super-automatic caliber .38. Its muzzle velocity is about 1200 feet per second and its striking energy about 400 foot pounds.

A similar pistol used largely by officers, uses the smaller 9mm Browning cartridge, which is identical with our .380 automatic Colt pistol cartridge.



# U. S. .45 1911 AND 1911A1 AUTOMATIC



**Caliber:** 45 M 1911 cartridge, ball ammunition.

**Magazine:** Box type, single line. Capacity 7 cartridges. (Note: Capacity of pistol is 8 cartridges, 1 in firing chamber and 7 in magazine.)

**Muzzle Velocity of Government Cartridge:** 810 feet per second.

**Muzzle Velocity of Commercial Cartridge:** 860 feet per second.

**Weight of Bullet:** 230 grains, lead with metal jacket.

**Muzzle Striking Energy, Government Cartridge:** 340 foot pounds.

**Muzzle Striking Energy, Commercial Cartridge:** 378 foot pounds.

**Barrel Length:** 5 inches.

**Overall Length of Pistol:** 8½ inches.

**Weight of Pistol:** 39 ounces.

**Sights:** Partridge type, fixed.

**Accurate Range:** 75 yards.

**Maximum Range:** About 1600 yards elevating pistol to 30°.

**Pistol Operated By:** Recoil.

**Locked:** Ribs on top of barrel lock in slots on underside of slide near breech until period of dangerous breech pressure is passed.

**Type of Fire:** Single shot only. One squeeze of trigger is necessary to fire each shot. Should more than one be fired by a single squeeze, pistol is dangerous and

disconnecter needs replacing.

**Magazine Release Catch:** Button on left side near trigger. Pressing it will eject magazine from handle.

**Position of Slide When Last Shot is Fired:** Open.

**Safeties:** (a) **Grip safety** prevents weapon from being fired until pistol is held firmly in hand. This safety is purely mechanical.

(b) **Thumb safety** at rear left end on receiver. When hammer is cocked, this safety may be pushed up into its slot in the slide; it locks hammer, sear and slide. This is an applied safety.

(c) **Disconnecter.** Positively prevents pistol being fired until slide and barrel are locked. This is an automatic safety.

**Differences Between Models 1911 and 1911 A1:** These pistols are identical except for the following improvements in the 1911 A1 model: (a) Tang on grip safety is longer to protect hand better. (b) Receiver is cut back on left side where trigger finger rests to allow more natural finger position. (c) Trigger face is cut back and ridged to afford better trigger pressure. (d) Mainspring housing at bottom of handle is arched and knurled to provide better grip. (e) Top of front sight is wider to help in quicker aiming.

**Note:** Model 1911 A1 is illustrated above. Model 1911 is shown in following photographs.



# U. S. .45 1911 AND 1911A1 AUTOMATIC

## INSTRUCTIONS FOR LOADING AND FIRING



1. **To extract magazine:** Press magazine catch (button). Magazine will normally be ejected and should be caught with left hand. If spring is weak, it may come only part way; withdraw it from handle.

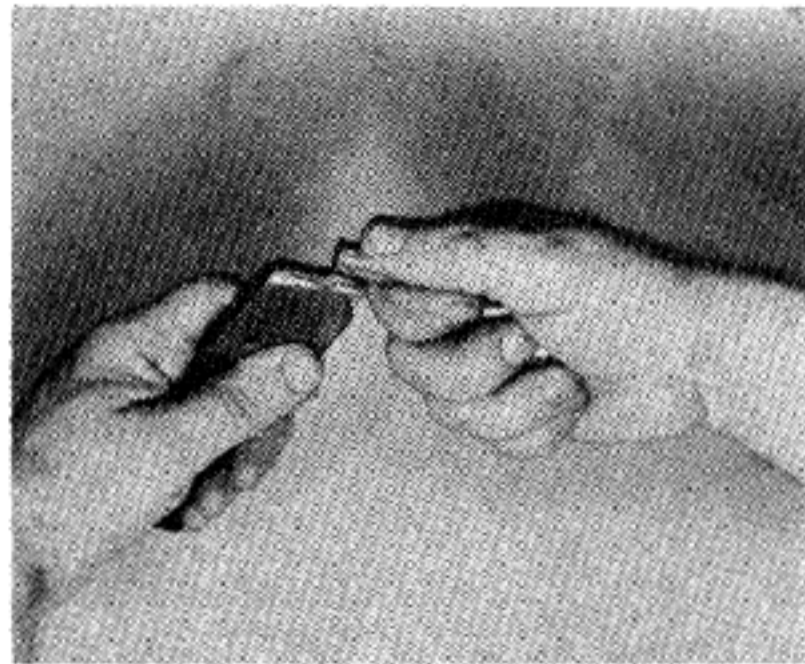

2. **Load magazine:** Holding firmly in left hand, press cartridge down on forward end of magazine follower (platform) and slide in under the curved lips of the magazine. Press following cartridges down as illustrated. Any number from 1 to 7 may be inserted.



3. **To load firing chamber:** (a) Holding pistol at height of right shoulder and about 6 inches from shoulder, insert loaded magazine and press home until it locks with a click. (b) Grasp slide with thumb and fingers of the left hand, thumb on right side of slide pointing upwards and pull back slide as far as it will go. This compresses the recoil spring, cocks the hammer and permits the magazine spring to push the top cartridge into line with the breech block. (c) Release slide. The recoil spring will drive it forward and feed a cartridge into the firing chamber; barrel will be forced up on its link and will lock into slide; firing mechanism will engage ready for first shot.



4. **To engage thumb safety:** Unless pistol is to be fired at once, always push safety lock up into place as soon as firing chamber is loaded. A stud on the inner face of the thumb safety locks the hammer and sear when the safety is pushed up into the slide. It can be released by simply pushing down on the thumbpiece.

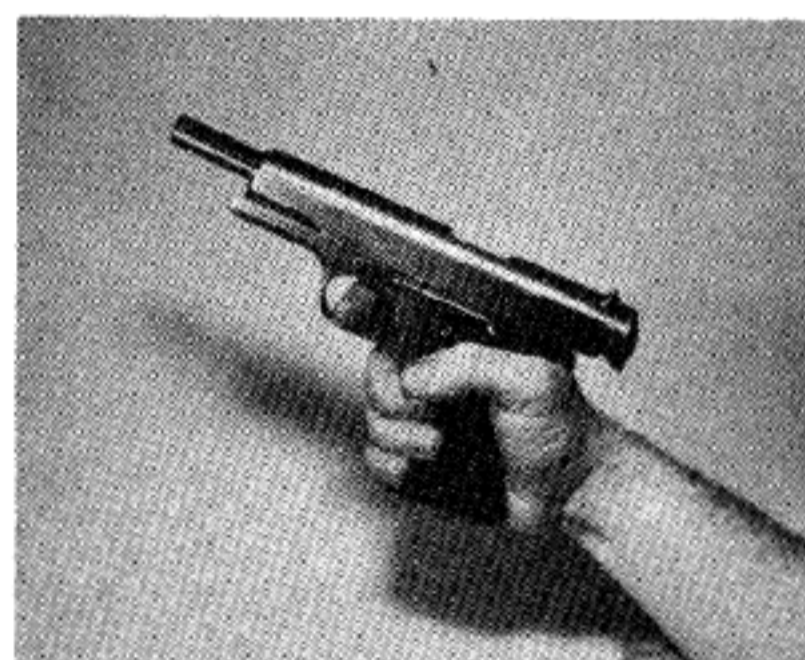

5. **Slide stop:** When the last shot has been fired, a section of the front end of the magazine follower, pushed up by the magazine spring, presses against the underside of the slide stop. This forces the stop up into a niche cut in the slide and holds the slide open as an indication that the pistol is empty.

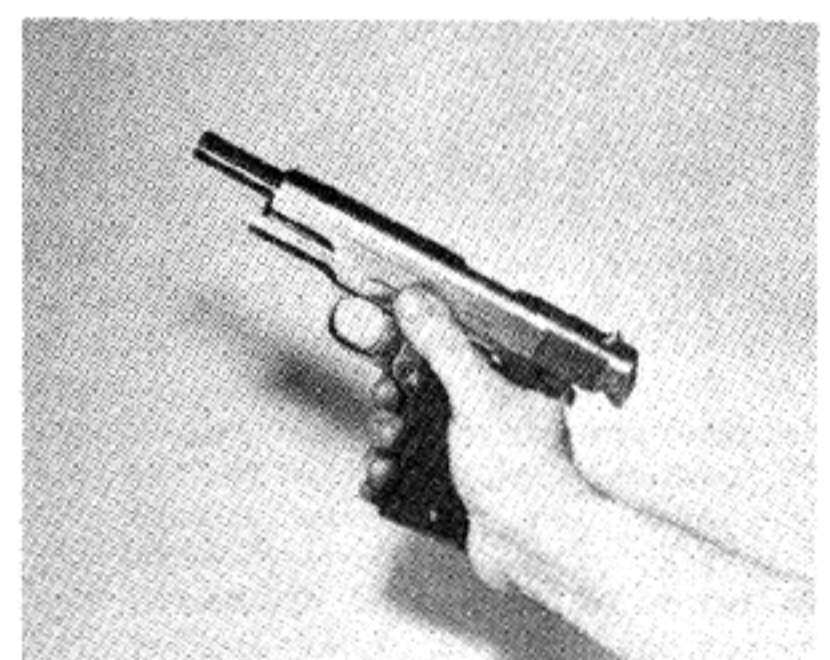

6. **Reloading from open slide:** (a) Press magazine catch and extract empty magazine. (b) Insert loaded magazine. (c) Push down on slide stop with right thumb. This will release the slide to drive forward and load the firing chamber.

**Note:** Slide stop cannot be released while an empty magazine is in the pistol. Slide will go forward only on a loaded magazine or when the magazine has been pulled part way out.



# U. S. .45 1911 AND 1911A1 AUTOMATIC

## FIELD STRIPPING

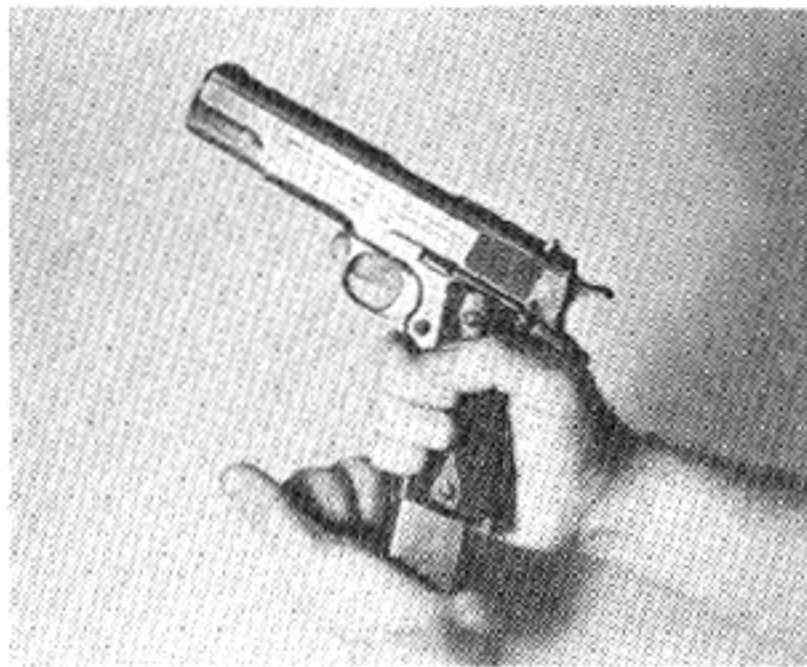

1. Remove magazine and examine firing chamber: (a) Press magazine catch and withdraw magazine. (b) Draw back slide and look into firing chamber through the ejection port to be sure the pistol is empty. Remember that even when the magazine is out, the pistol is still dangerous: there may be a cartridge in the chamber.

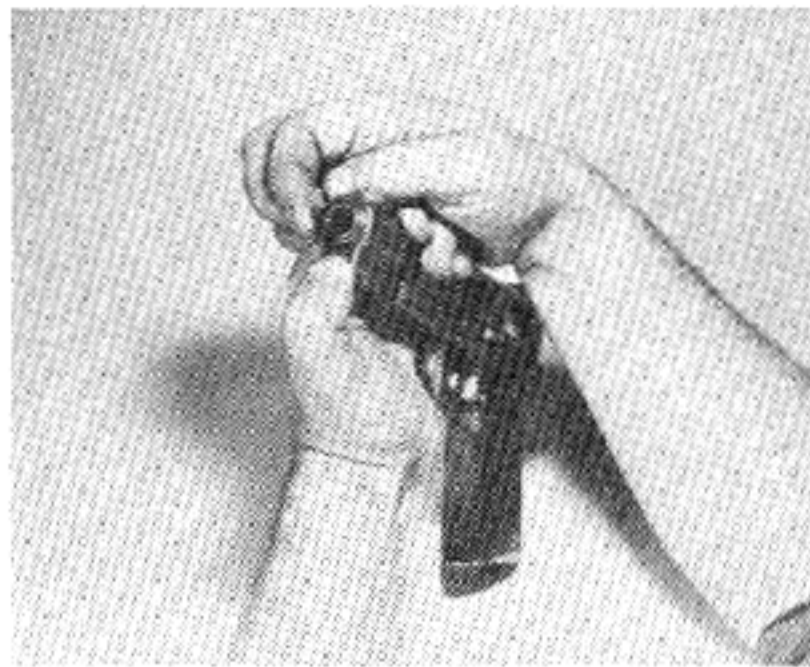

2. Release tension of recoil spring: (a) Press in on plug which covers end of recoil spring, using thumb or butt of magazine if it is too stiff. (b) Barrel bushing, freed from spring tension, may now be turned to the right side of the pistol.

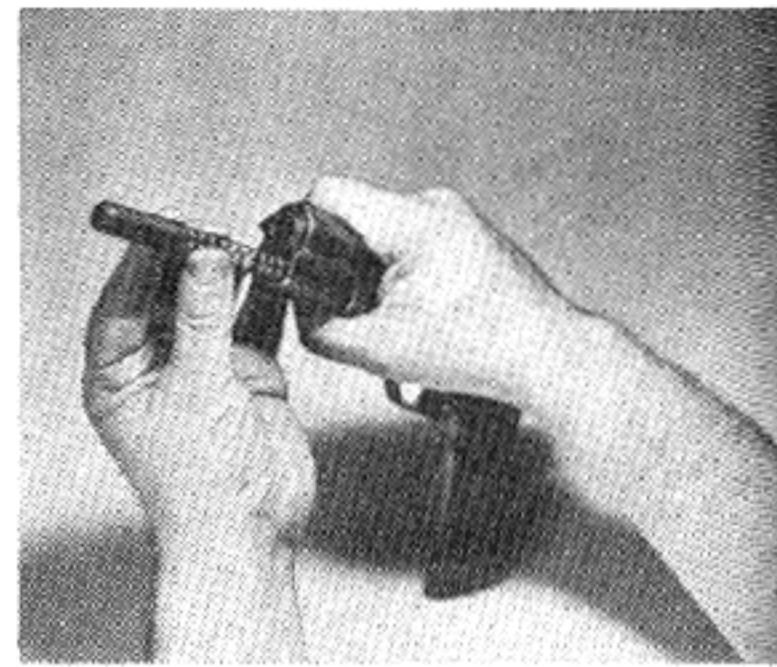

3. Ease out plug and recoil spring: The spring is very powerful. Take care not to let it fly out of the pistol. Do not withdraw these parts from the pistol yet, as they serve to keep the recoil spring guide in place and make the next step easy.

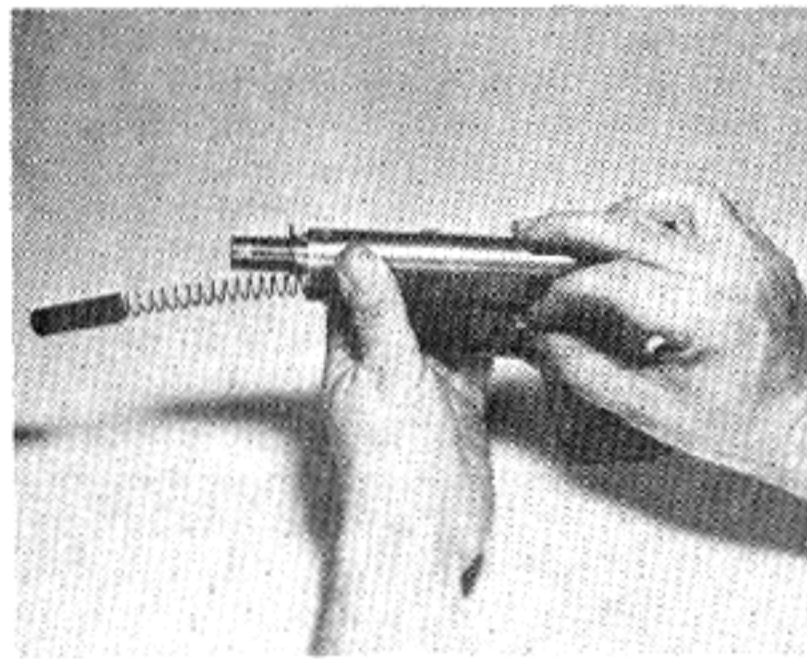

4. Remove slide stop: (a) Push slide back until the rear edge of the smaller recess in the lower edge of the slide is even with the rear end of the slide stop. (b) Now press from the right side against the protruding pin which is part of the slide stop. This pin passes through the right side of the receiver, then through the barrel link which hold the barrel, then through the left side of the receiver. (c) Now pull slide stop out from left side of pistol.

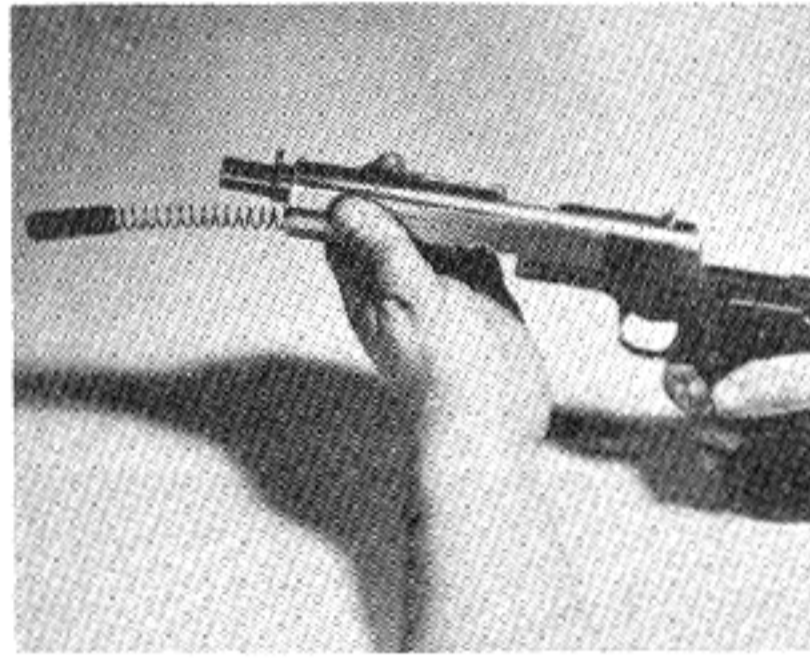

5. Remove slide and components: Pull slide forward on its guides in the receiver and remove. With the slide will come the barrel, barrel link, barrel bushing, recoil spring and recoil spring guide.

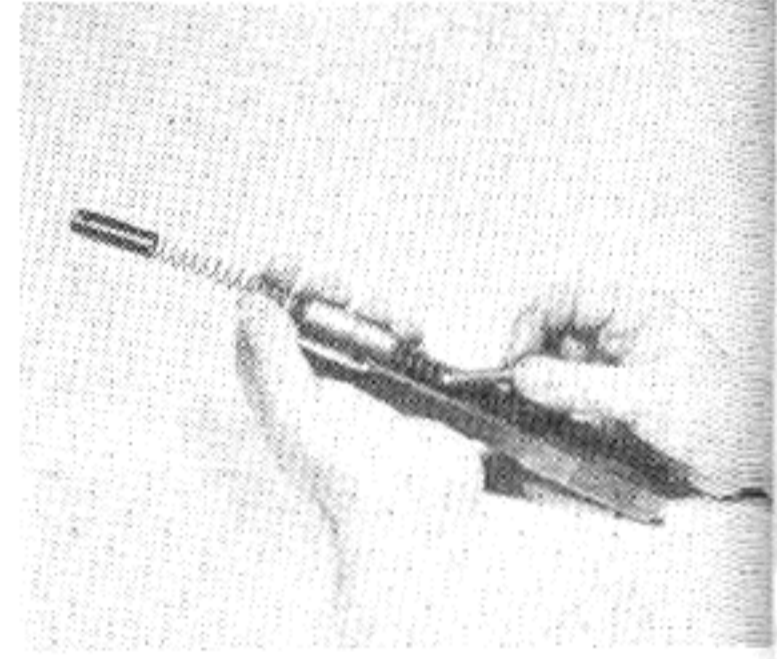

6. Remove recoil spring guide: (a) The recoil spring guide (on which the recoil spring compresses) may now be lifted out to the rear. (b) The recoil spring and plug are pulled out from the front. (c) The barrel bushing is turned to the left which unlocks it so it can be withdrawn.



7. Remove barrel: Turn barrel link forward on its pin and withdraw from the front of the slide.

Note: Normally no further stripping of this pistol is required.



8. To remove firing pin: (a) Should it be necessary, the firing pin may be easily removed by pressing the pin in against the tension of its spring, at the same time pushing down on the firing pin stop which holds the firing pin in place. This may be done with a nail, match or similar object. (b) Slide the stop down out of its grooves and ease out the firing pin and spring.

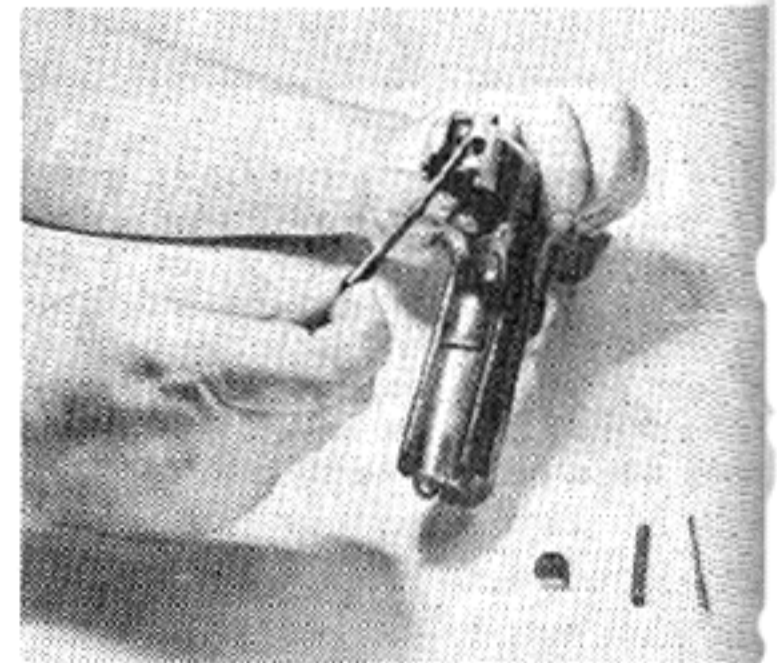

9. To remove extractor: When the firing pin has been removed, the extractor, which is a long piece of spring steel inserted in a hole to the left of the firing pin, may be pried up and pulled out to the rear as illustrated.



# U. S. .45 1911 AND 1911A1 AUTOMATIC

## FIELD STRIPPING

While no stripping beyond that illustrated is ever necessary to clean and properly care for this pistol, the following instructions will be helpful to those who wish to master every detail.

**To Remove Safety Lock:** (a) Cock hammer. (b) Grasp thumbpiece of safety lock between thumb and index finger, pull steadily outward and at same time move back and forth.

**Remove Hammer:** (a) Lower hammer—do not snap it. (b) Use safety lock to push out hammer pin, removing from left side. (c) Lift out hammer and hammer strut.

**Remove Mainspring Housing:** (a) Using hammer strut, push mainspring housing pin out from right side of receiver. (b) Slide housing and its contained spring

down out of its guides. (c) Pushing in on mainspring cap, at same time push out mainspring cap pin.

**Remove Sear and Disconnecter:** Using hammer strut, push out sear pin from left side of receiver and remove sear and disconnecter.

**Remove Magazine Catch:** Press in checkered left end to permit turning catch lock a quarter turn to left out of its seat in receiver, using long leaf of sear spring. Catch, its lock and spring may now be removed. Be careful not to let spring jump away when released.

**Remove Trigger:** Pull straight to the rear.

**Remove Slide Stop Plunger, Safety Lock Plunger and plunger spring:** Draw straight to rear.

## NOTES ON ASSEMBLING

(1) **Barrel link** must be tilted **forward** and link pin properly in place before it will slide into place in the slide.

(2) Put **sear** and **disconnecter** together, hold by their lower ends, place them in the receiver and replace sear pin.

(3) **Sear spring** should be replaced after **sear** and **disconnecter** are in place, care being taken that lower end is in its place in the cut in the receiver; upper end of left hand leaf resting on sear.

(4) Insert **mainspring housing** until lower end projects about one-eighth inch below frame. Then (a) Replace

hammer and pin; (b) Grip safety; (c) Cock hammer and replace safety lock; (d) Lower hammer and push **mainspring housing** home, and insert pin.

(5) Cock hammer. Insert end of magazine follower to press safety lock plunger home.

(6) When inserting slide stop, make sure that its upper rear end stops on the receiver just below the small slide stop plunger. Then push stop upward and inward with the one motion. This will enable the upper round part of the stop to push the plunger back and let the stop snap into place.

## DESCRIPTION OF MECHANISM

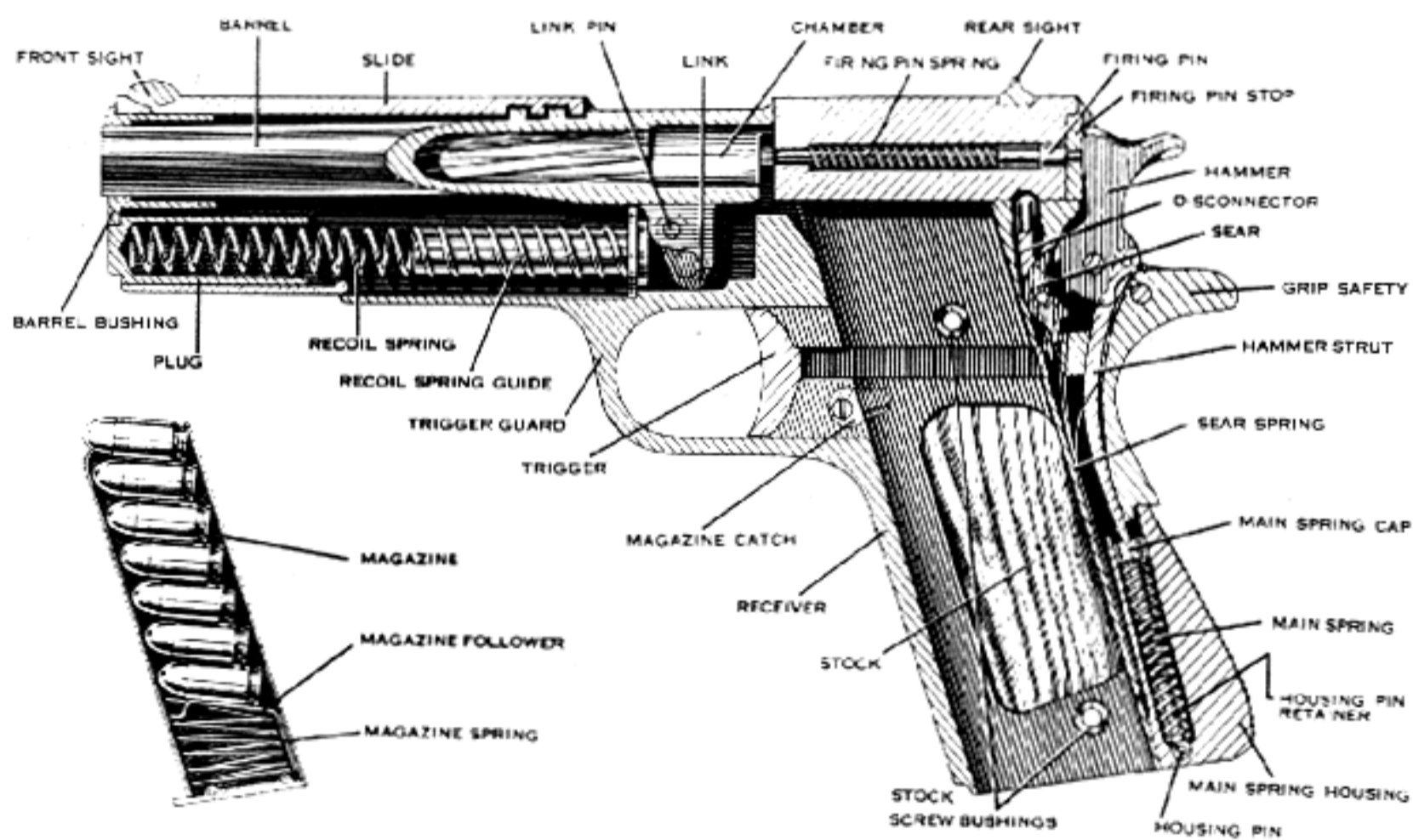

The pistol has three main parts: receiver, barrel, and slide. The receiver is fitted with guides in which the slide runs. Its handle is hollow to permit insertion of the box magazine which is locked by the magazine catch.

The receiver also holds the trigger whose front end projects through the trigger guard. The firing mechanism, made up of the hammer, sear, automatic disconnecter, grip safety and safety lock, are at the rear of the receiver. Here too are the mainspring and sear

spring. The mainspring is a coiled spring seated within the mainspring housing which is held by the mainspring cap pin. The mainspring cap and housing pin retainer are also in this housing.

The sear spring is a flat spring with a rib fitting into a slot in the rear wall of the receiver to prevent the spring from moving vertically. The mainspring housing bears against the rear of the spring and locks it into position to give it the required tension.



# U. S. .45 1911 AND 1911A1 AUTOMATIC

A bent metal piece called the hammer strut is fastened to the hammer by a pin in rear of its pivot, while its end rests in the mainspring cap. In a tube above the handle are the slide stop and safety lock plungers whose ends protrude from front and rear of the tube respectively, as well as the spiral spring plunger seated between the two which yielding holds them in position.

The ejector, a solid piece of metal against which the head of the withdrawn cartridge case strikes, is fastened to the top of the receiver near the rear end.

The top of the receiver extending forward above the trigger guard forms a semi-tubular extension to provide a seat for the rear section of the recoil spring.

The barrel has two transverse locking ribs on its rear upper surface. They positively lock into corresponding slots on the inside of the slide when in firing position. The lower rear end of the barrel is attached to the receiver by a swinging link and pin. It can thus move a limited distance **lengthwise and downwards**.

The heavy slide mounts on the receiver **from the front end** and the distance of its rearward movement is controlled by a tubular abutment which absolutely prevents it being thrown rearward from the receiver.

In this abutment at the front end of the slide rests the forward portion of the recoil spring and the plug which fits over its end; while the rear end of this spring

is fitted over a removable guide which is supported by the shoulder at the front of the receiver.

A barrel bushing is inserted in the front of the slide over the barrel and locks when turned down into place. It serves to retain the recoil spring and the plug and also supports the muzzle end of the barrel.

When the barrel and slide together are mounted on the receiver, the slide stop is in place, its pin passing through the receiver from side to side and through the barrel link, thereby positively locking slide, barrel, and receiver together.

The exterior of the slide stop is provided with a checkered thumb piece to be pressed for releasing slide from the open position. When the safety lock is pushed into the upward position, it enters a recess on the slide and a stud on the inner face at the same time locks the sear and hammer when in the full cocked position. This safety can only be applied when the pistol is cocked.

The grip safety is a curved metal piece pivoted in the upper part of the receiver. It acts automatically to lock and release the firing mechanism without any attention on the part of the shooter.

The disconnector is a small lever which when pressed down prevents the trigger mechanism from engaging with the sear and hammer in all positions except when breech is **fully closed**. This also prevents more than one shot from following each pull of trigger.

## HOW THE PISTOL WORKS

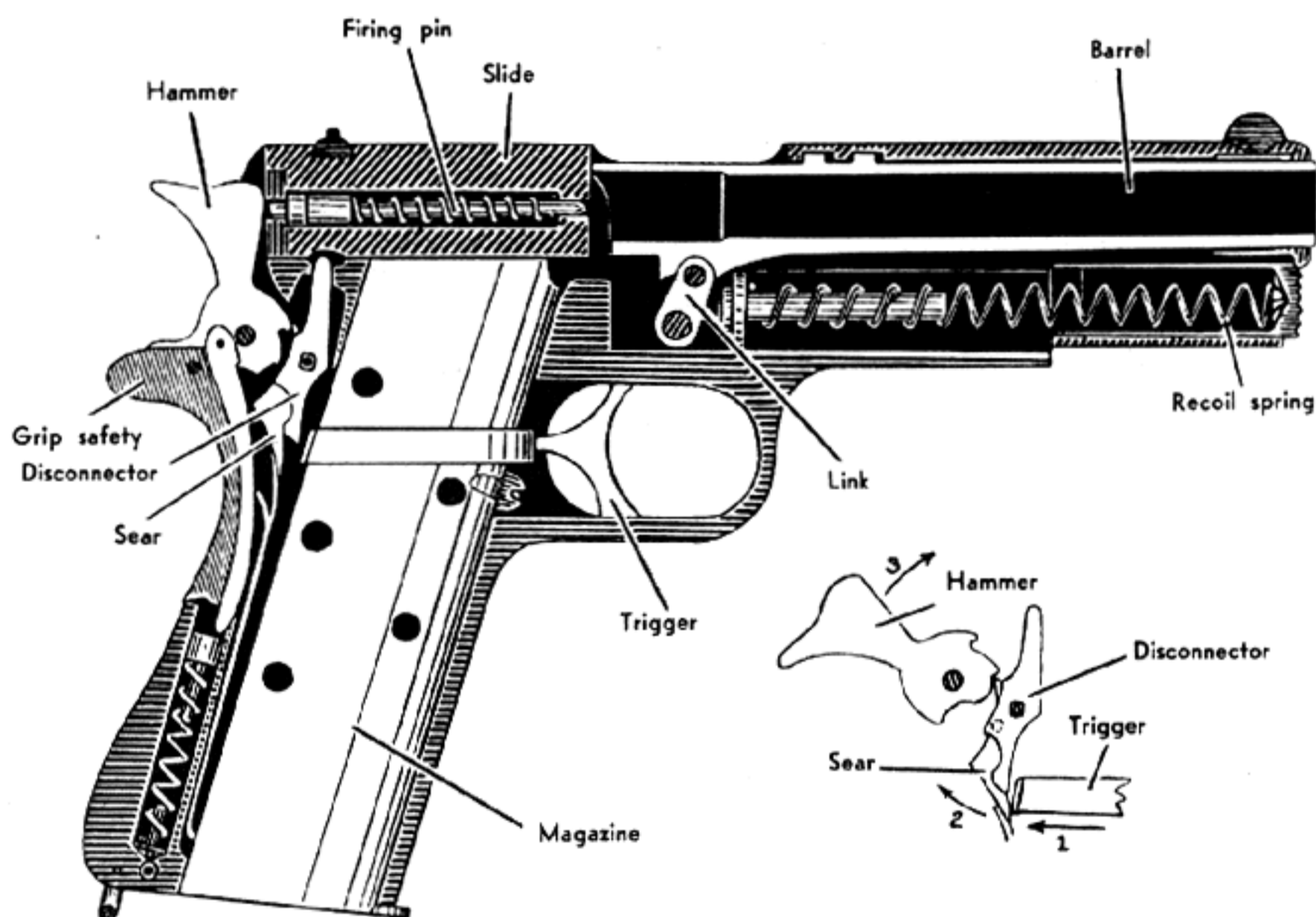

1. A magazine holding any number of cartridges from 1 to 7 is inserted in the handle and pushed in until it locks. This locking is produced by the thumb catch lock snapping into a notch cut in the upper front end of the magazine.

2. As slide is drawn back for the opening movement, it compresses a recoil spring, and forces the hammer back and down to full cock. Here it is held in position

by the sear. As the slide goes back the disconnector is pressed back, positively preventing the trigger from connecting the firing mechanism. When slide is to the rear as far as it will go, it clears head of the magazine, and the magazine spring feeds a cartridge up in line with the breech.

3. The slide on being released is forced forward by the recoil spring and the breech bolt face of the slide



# U. S. .45 1911 AND 1911A1 AUTOMATIC

carries the first cartridge into the barrel chamber. As the slide nears its foremost position, the face of the breech bolt comes against the rear extension of the upper part of the barrel forcing the barrel forward and upward on the barrel link. When the slide and barrel reach the full forward position, the locking ribs are positively locked into the corresponding grooves on the inside of the slide.

The firing pin spring, firing pin, and the extractor are located in the breech bolt section of the slide. As the cartridge is seated in the barrel chamber, the extractor, which is made of heavy spring steel, springs over the head and into the cannellure of the cartridge, thus preparing it to be drawn back during the rearward motion of the pistol for extraction.

The firing pin is a "flying" one. It is seated in the breech block surrounded by its spring. It is shorter than the breech block itself. Thus if the hammer is lowered all the way down on the firing pin, it will push the pin inside the breech block but cannot push it far enough to make it rest against the primer in the cartridge. The one way in which the firing pin can touch the primer is when it is struck a sharp blow by the hammer itself. As the hammer falls, it drives the firing pin ahead to strike the primer and is stopped itself by the face of the breech block. The inertia of the firing pin causes it to fly ahead and strike the primer, then its compressed coil spring pulls it back into the breech block.

The pressure of the powder gases driving the bullet down the barrel also drives the empty case back against the base of the breech block pushing the slide and barrel together rearward, until the bullet is safely out of the barrel. At that point the barrel swings downward on its pivoted link leaving the slide free to continue direct rearward motion in its guide in the receiver, extracting and ejecting the empty shell, cocking the hammer, compressing the recoil spring for the next forward movement.

**Breech Pressure:** When the .45 automatic pistol is fired, a pressure of 14,000 lbs. per sq. inch is generated

in the firing chamber. Since the base of the bullet has an area of .159 sq. inch, a total pressure of 2,225 pounds is exerted against the base of the bullet, driving it forward down the barrel; and back against the face of the breechblock driving it backwards.

The bullet, weighing only a fraction as much as the moving section of the pistol, gets under way much more quickly **and utilizes most of the pressure** as it travels down the barrel. The speed of the pistol's motion as compared to that of the bullet is relative to the weight of the pistol as against the bullet.

Thus the bullet is well out of the barrel before the pistol has recoiled sufficiently to permit the locking mechanism to open. The pressure, of course, lasts only for a very small fraction of a second. However, in high powered military pistols of comparatively low weight, it is necessary that the breech be positively locked until the bullet has left the barrel. The locking principle on the .45 automatic pistol, model 1911, is among the best ever designed.

**How the Slide Stop Works:** The forward end of the magazine follower is split in two longitudinally for a short length. The left hand section is bent down below the level of the follower.

When the last cartridge has been stripped from the magazine, the follower rises under the influence of the magazine spring, and the bent section presses against the rear of the inside of the slide stop; thus forcing the projection on the top of the stop up into line with the large notch in the base of the slide into which it locks.

The slide will not go forward while the magazine is empty. If the empty magazine is extracted, pressing on the slide stop will permit slide to run forward by pulling the stop down out of its locking notch. If a loaded magazine is inserted in the handle, then the magazine follower with its bent arm is in position below the cartridges on the inside of the magazine. Hence, if the slide stop is pushed down when a **loaded** magazine is in the handle, it will release the slide to run forward and load the chamber.



# U. S. SMITH AND WESSON .45 1917 REVOLVER

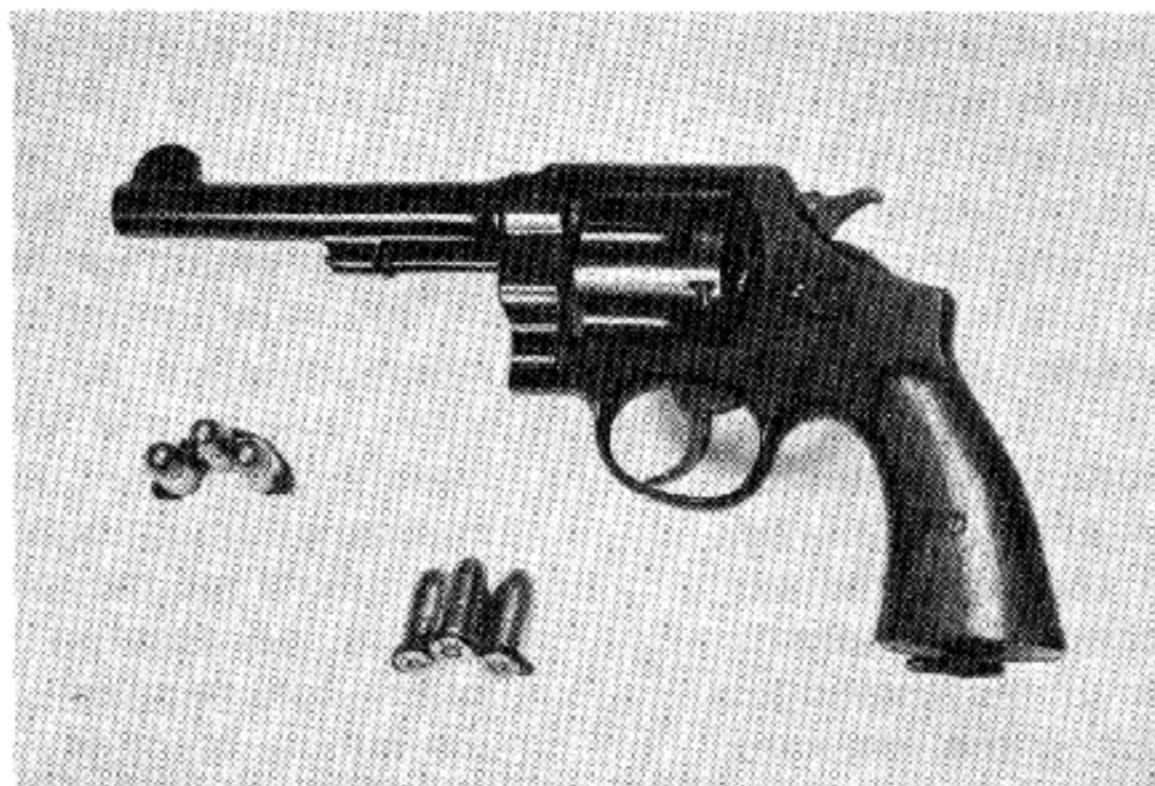

**Caliber:** .45 M1911 cartridge, with clips.  
**Cylinder:** 6-chambers.  
**Muzzle Velocity:** About 810 feet per second.  
**Weight of Bullet:** 230 grains, lead with metal jackets.  
**Striking Energy:** 340 foot pounds.  
**Barrel Length:** 5½".  
**Overall Length of Revolver:** 10¾".  
**Weight:** 36¼ ozs.  
**Sights:** Service type front, square notch rear. Fixed.

**Accurate Range:** 75 yards.

**Maximum Range:** About 1600 yards.

**Lock:** Cylinder is locked in rear and the arm of the crane has a latch to lock it to the front end of the frame. The ejector rod latches into place at extreme front end of housing below barrel.

**Safety:** Hammer rebounds automatically after striking cartridge, and can strike at primer only when the trigger is deliberately pulled.

## HOW THE SWING-OUT CYLINDER WORKS

Swinging out the cylinder gives access to the cylinder and barrel for all normal cleaning purposes. Actual takedown of any revolver is ordinarily unnecessary and is a job for a skilled armorer. The spring and lever system is so complex that attempts at stripping should be discouraged.

When the thumb latch is pushed it forces forward the locking pin which passes down the center of the ejector rod. Thus simultaneously the locking pins at the rear of the cylinder and at the extreme end of the ejector rod are both released, permitting the cylinder to be swung out on its crane to the left of the revolver.

## LOADING AND FIRING

This revolver was designed to use the rimless .45 Government Automatic Pistol cartridge. Revolver cartridges must have **rims to catch on the cylinder and over the head of the extractor to permit extraction.** Automatic pistol cartridges, on the other hand, should be **rimless, so they will lie properly in place on top of each other in the magazine** and will feed in and out of the action with a minimum of difficulty.

S & W 1917 No. 2

To make it unnecessary for the Army to use **special cartridges for revolvers**, Smith & Wesson developed steel half-moon clips, into which three automatic pistol cartridges can be placed. These clips slip into the cannelures of three cartridges and lock them securely. Thus it is possible to load the 6-chambers of the cylinder with **two motions.**

Smith & Wesson cylinders are constructed with a shoulder at the lower end of each chamber as is customary in the automatic pistol, and if one has automatic pistol cartridges but no clips, the cartridges may be individually loaded into the chambers and will rest on these shoulders. The revolver may now be fired in the ordinary way. However, since there are no rims on these individually loaded cartridges for the extractor to catch on, pushing back on the ejector rod will not take them out of the chambers as they are not held by the extractor. Sometimes they may be shaken out, but normally they will have to be dug out with a knife or punched out with a pencil or some similar instrument.

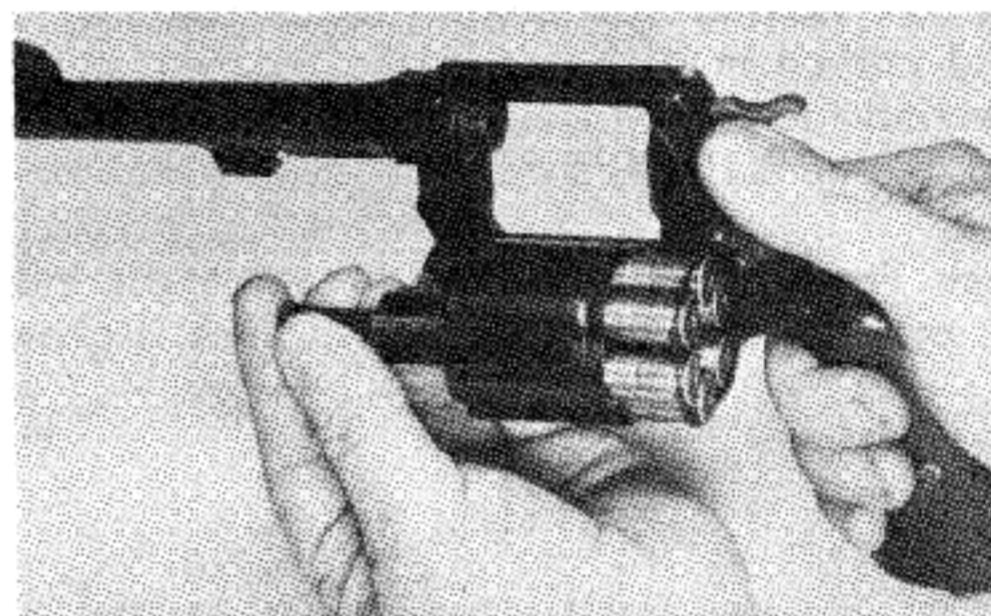

## NOTE ON AMMUNITION

A cartridge known as the .45 Auto-Rim is commercially manufactured in the United States for use in this revolver **without the use of a clip.** Cartridge is similar to the automatic pistol cartridge except that it has a revolver-type rim. This converts it to a typical revolver cartridge. Ballistics are practically the same as for standard .45 Automatic Pistol cartridge when it is fitted with a metal-jacketed bullet. This cartridge may also be obtained with a lead bullet. The velocity obtained will be rather lower than that obtained in the automatic pistols, because in the automatic the firing chamber is a part of the barrel and no gas escapes. In the revolver there is a gap between the cylinder and the barrel; and as the bullet jumps this gap some gas must escape. Note: When revolver gives better velocity than pistol, it is because the barrel is longer.



# U. S. SMITH AND WESSON .45 1917 REVOLVER

## HOW THE REVOLVER WORKS

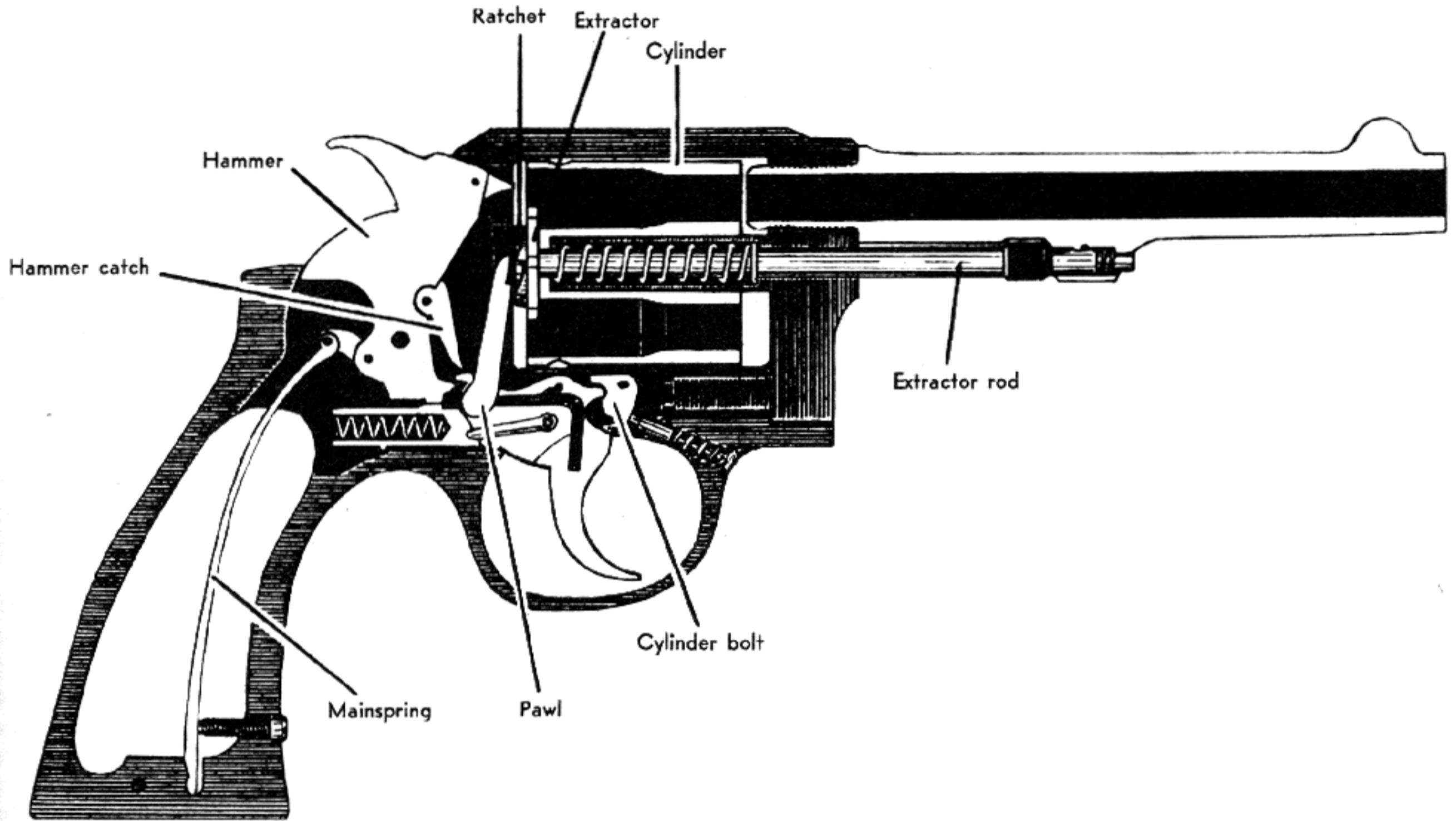

As hammer is drawn back by thumb or by action of trigger its underside catches below the trigger nose and draws the rear end of the trigger up and back. When the hammer reaches full cock, it will be held there by the trigger nose. As the hammer goes backwards, it compresses the flat mainspring in the grip. During the rearward motion of the hammer, the attached hand or pawl pushes up against the ratchet on the face of the extractor and revolves the cylinder the full distance of one firing chamber. This movement is made possible by the hammer moving a rebound lever which depresses the cylinder stud freeing the cylinder to move. The cylinder is locked securely to the frame by the cylinder catch stud positioned in the center of the extractor and supported by a strong spring. This stud enters a locking recess in the frame and is held in position there under the influence of the spring until the thumb latch is pushed forward to relieve the tension and permit cylinder to be swung out. **This cannot be done while the hammer is at full cock.**

When the trigger is squeezed, the hammer is released, to go forward and strike the cartridge in the chamber lined up with the barrel. As the finger lies loosened slightly for the next shot, a spring pushes the trigger back into position and the hammer immediately rebounds against the top of the rebound stop and is prevented from going forward again except on complete pull of the trigger. The forward end of the rebound stop and the rebound arm on the hammer are so shaped that the forward motion of the stop pushes the lower part of the hammer forward and takes the nose of the hammer to the rear.

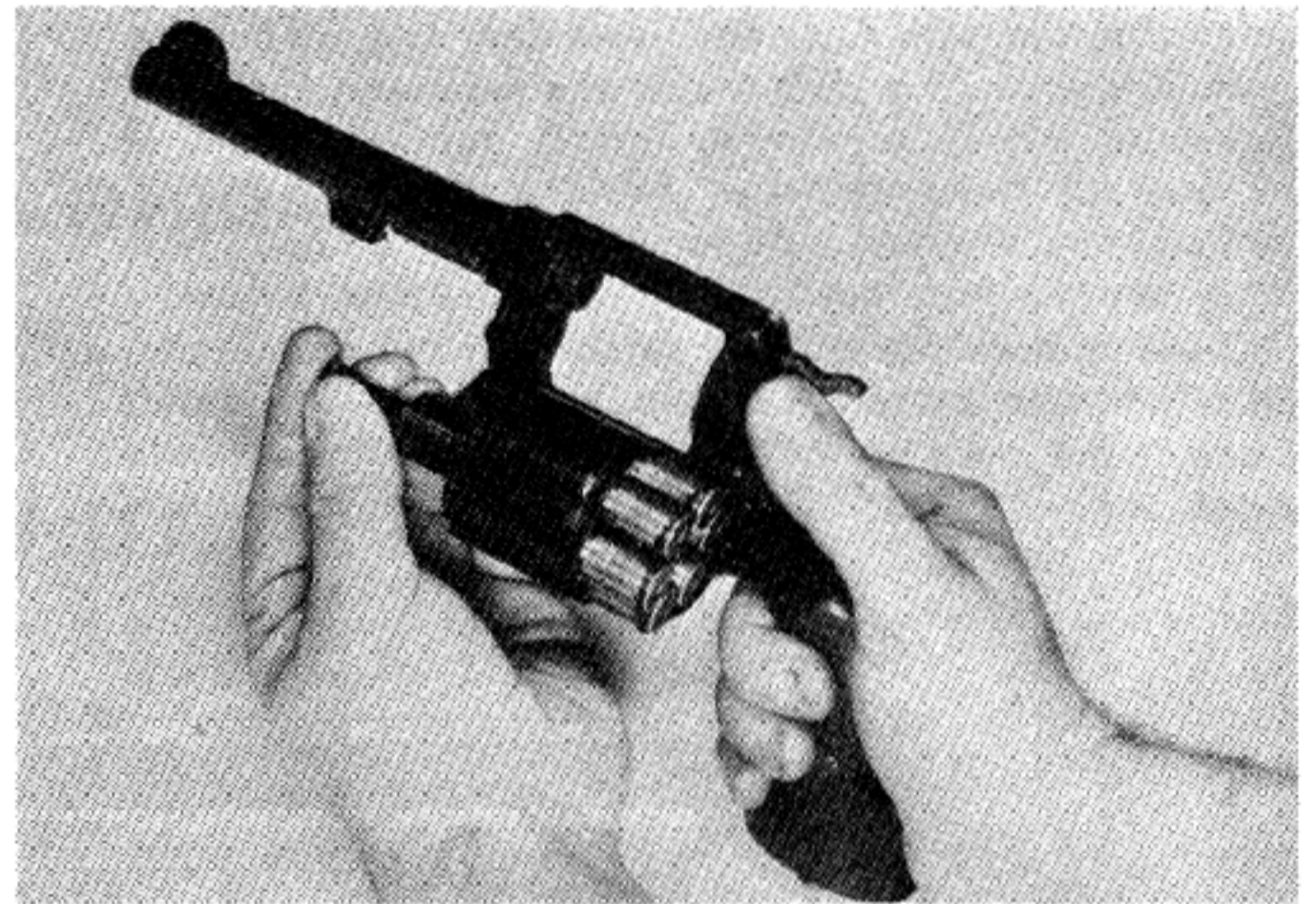

**Ejection of Empty Cartridge Cases:** The cylinder being swung out to the left, pressure with hand on the ejector rod will compress the spring, force up the star-type extractor which fits around the rim of each cartridge, and which is attached to the ejector rod mounted in the center of the cylinder, and will raise empty shells completely out of the revolver. When the hand is removed the compressed ejector spring will force the ejector and extractor back into place in the cylinder.



# U. S. COLT .45 1917 REVOLVER



*Colt, M1917*

**Caliber:** .45 Model 1911 cartridge, used with half-moon clip.

**Cylinder:** 6-chambers.

**Ballistics:** About same as for automatic pistols.

**Barrel Length:** 5½".

**Overall Length:** 10¾".

**Weight:** 40 ozs.

**Sights:** Fixed.

**Type of Fire:** Single action or double action.

**Cylinder Latch on Left Side Plate:** Must be drawn back to release cylinder.

**Safety:** Fitted with Colt positive safety lock. This is a small intercepting slide inside the frame on the right

side terminating in a block between the frame and the breast. This block is entirely automatic, and unless the trigger is deliberately pulled the face of the hammer cannot come far enough forward for the firing pin to reach the cartridge in the chamber. This revolver cannot be fired unless the hammer has gone to full cock, the trigger been pulled and the hammer driven forward by the main spring. If the swing-out system is not fully home and locked by the latch pin, its projection into the lock chamber interferes with the movement of the safety lock and the weapon can be neither cocked nor fired.

## LOADING AND FIRING

**Drawing back** the cylinder latch with the thumb permits the cylinder to be swung out to the left on its crane. The cylinder is loaded, then swung back into place until it clicks. The revolver may be fired now

either by drawing the hammer back to full cock (single action) or by double action, that is, by drawing back on the trigger until the cylinder revolves and locks and the hammer cocks and is released to fire the cartridge.

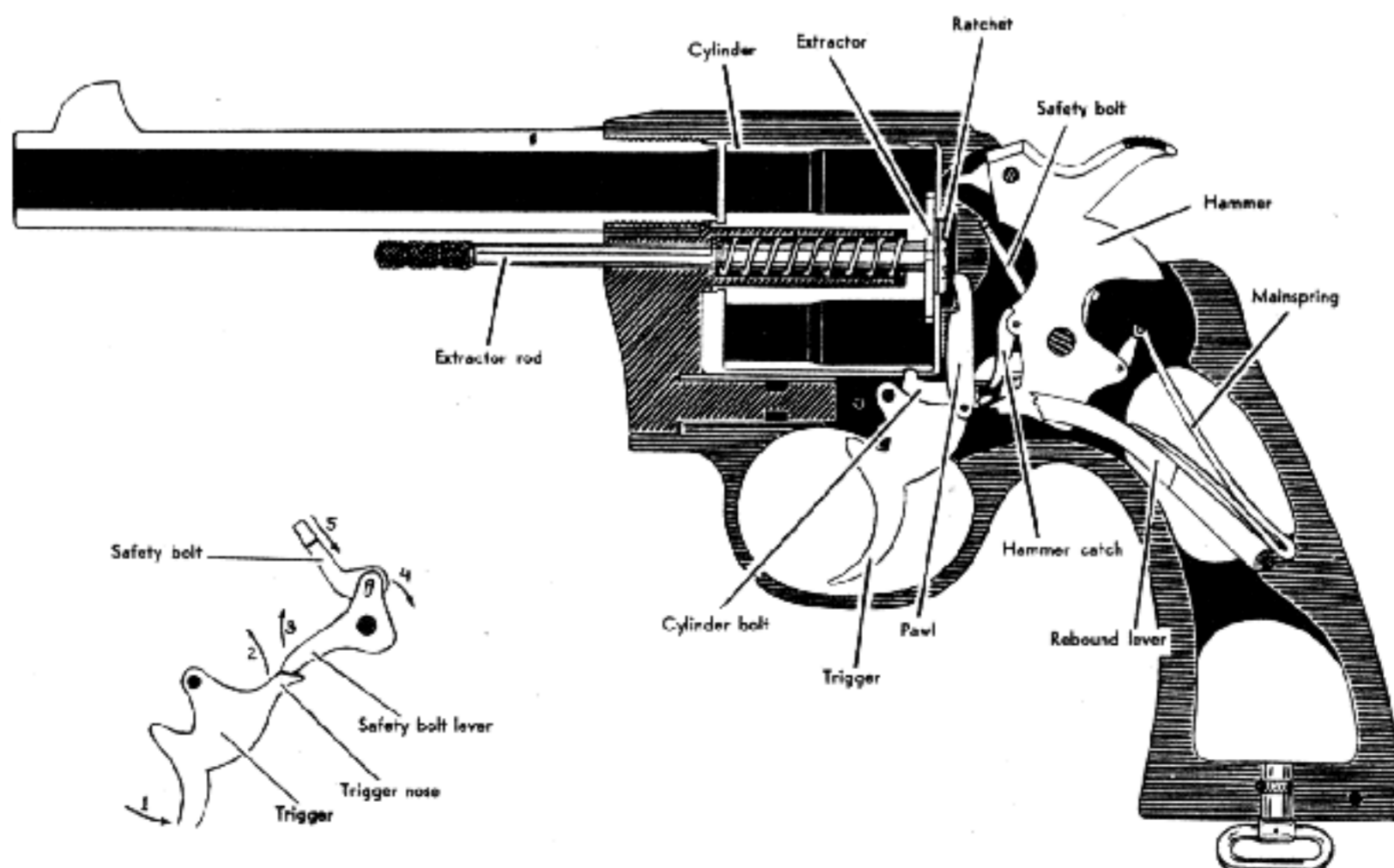



# U. S. SPRINGFIELD .30-06 1903 RIFLE

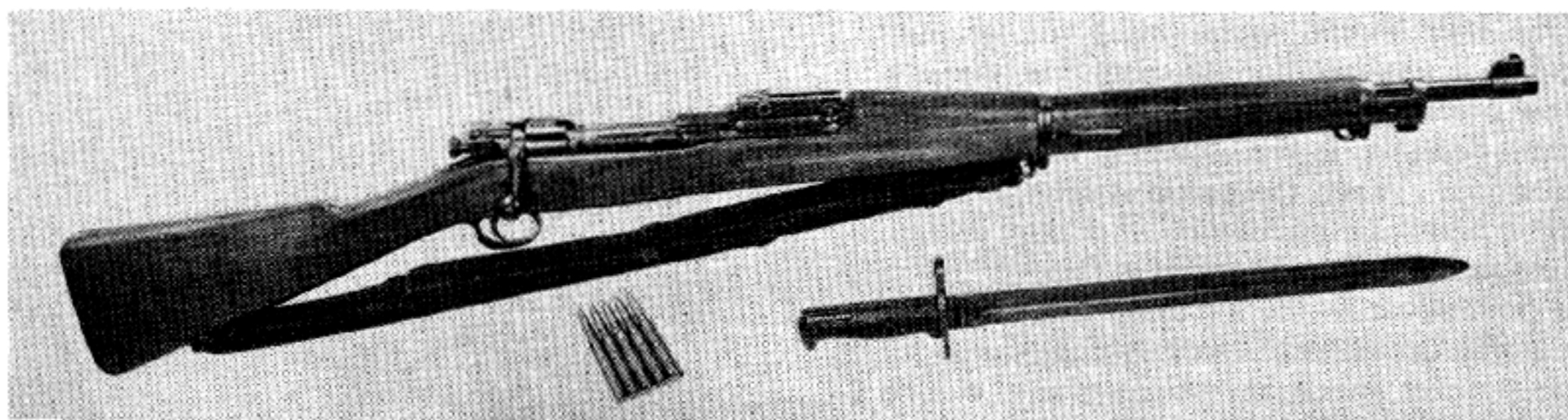

**Caliber:** .30-06, M1 and M2.

**Magazine:** Staggered box type in receiver, capacity 5 cartridges. When magazine is loaded, pressing down on cartridge with left thumb will permit pushing bolt handle slightly forward over top cartridge. Magazine cut-off may now be turned to "off." An extra cartridge may now be fed by hand directly into the firing chamber.

**Cartridge Clip:** Holds 5 cartridges.

**Muzzle Velocity:** About 2700 feet per second. 2800 with M2 ammunition.

**Striking Energy:** About 2680 feet pounds.

**Barrel Length:** 24".

**Overall Length of Rifle:** 3' 7 $\frac{1}{4}$ ". With bayonet 1" longer.

**Weight of Rifle:** 8.69 lbs. With bayonet, about 9 lbs. 8 ozs.

**Front Sight:** Blade type, fixed.

**Rear Sight:** When leaf is down, a rear "U" is in line with the eye. This is the battle sight, set for 530 yards range. When leaf is snapped up, a screw-adjusted slide can be set in stages of 100 yards from 100 to 2350. Near the base of the slide is a small aperture, then an open triangle with open sight notch, and on top another sighting notch, in upper edge of leaf. As sight is elevated, it is moved over to the left by a drift slide, which automatically compensates for drift of the bullet. The sight leaf has lines across it for setting sights in stages of 100 yards; while in between these stages are shorter lines for 50-yard and for 25-yard divisions or sub-division. 100 to 2350

## LOADING AND FIRING

**Used as a single shot rifle.** Check the magazine cutoff on the left side of the receiver, making sure that it is down and the word "Off" can be seen stamped on the cutoff. Turn the bolt handle up as far as it will go. This will release the locking lugs from their recesses in the receiver, and permit the bolt to be drawn straight back. Now place a cartridge in the firing chamber, thrust home the bolt to seat the cartridge properly and permit the extractor to snap over the cannellure of the cartridge case, and turn the bolt handle down as far as it will go to lock the piece. Note: This rifle is cocked as the bolt is drawn to the rear. The knob on the cocking piece will project out of its casing when the weapon is at full cock. If desired, the safety lock may now be applied, by turning the safety lock thumb piece at the rear of the bolt over to the right as far as it will go, when the word "Safe" will be seen on its face.

If safety is not set, pressing the trigger will explode the cartridge in the firing chamber, which then may be

yard ranges can be obtained through aperture. Ranges of 100 to 2450 yards can be obtained through the open notch at the bottom of triangle. And ranges from 1400 to 2750 through open sighting notch in upper edge. The maximum sight range of 2850 yards can be obtained by using the open notch in the upper end of the leaf.

**Most Effective Ranges:** Up to 600 yards.

**Penetration:** At close distances, this rifle will send a bullet through 70 or more pine boards  $\frac{7}{8}$ " thick. At 600 yards it will penetrate 15" of board.

**Trajectory:** Extremely flat, only  $\frac{1}{2}$ " at 100 yards, and 6" at 300 yards.

**Locked:** By turning bolt. Mauser type.

**Cutoff:** A thumb cutoff is provided on the left side of receiver. When this is turned down, single cartridges may be inserted in the firing chamber. When cutoff is up, cartridges will feed from magazine and magazine follower will hold bolt open when last cartridge has been ejected.

**Safety:** Thumb piece on rear end of bolt. When rifle is cocked, it can be switched over to the right, in which position it is safe. When in normal position on the left, the rifle is ready to fire.

**Automatic Safety:** A special mechanical design makes it impossible to fire the cartridge unless the bolt is fully locked. If bolt is not fully home, a cam on the cocking piece strikes the cocking cam on the bolt itself and the mainspring energy will be expended in forcing the bolt shut, not in striking the primer. A misfire occurs when this happens.

extracted and ejected by turning up and pulling back sharply on the bolt handle.

**To Load Magazine:** Turn cutoff up as far as it will go and the word "On" will appear. Now lift up and

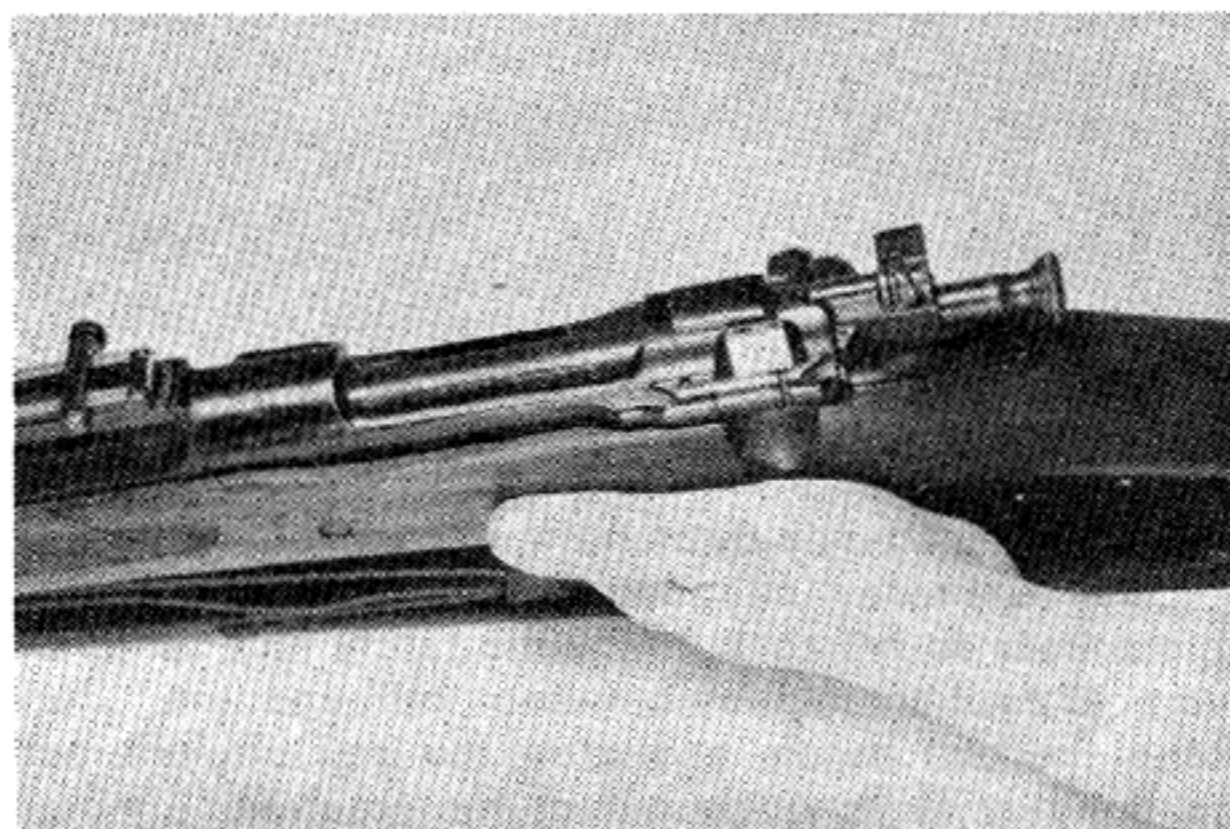



# U. S. SPRINGFIELD .30-06 1903 RIFLE

pull back on the bolt handle as far as it will go, and since the cutoff is in the position of magazine loading, the bolt will be permitted to travel further back than when single shot firing is to be done with the cutoff in the "Off" position. When the cutoff is set for magazine loading, the bolt can be drawn back far enough to permit the magazine follower to rise in front of it.

With muzzle pointed up in the air at an angle of 45°, insert a loaded clip in the clip slots; place thumb of right hand over powder space on top cartridge, extend fingers around the rifle with tips resting on magazine floor plate, and with thumb force the five cartridges down into the magazine. Now pull out the empty cartridge clip. Push the bolt home and turn down the locking handle. Set the safety lock on the "Safe" position unless weapon is to be used at once.

To load rifle with 6 cartridges, proceed as follows: With cutoff set in the "On" position, raise and draw bolt handle back as far as it will go. Load magazine with full clip as above. With left thumb push down on top cartridge, forcing it down below the line of the bolt; and push the bolt slightly home over it. Now insert a

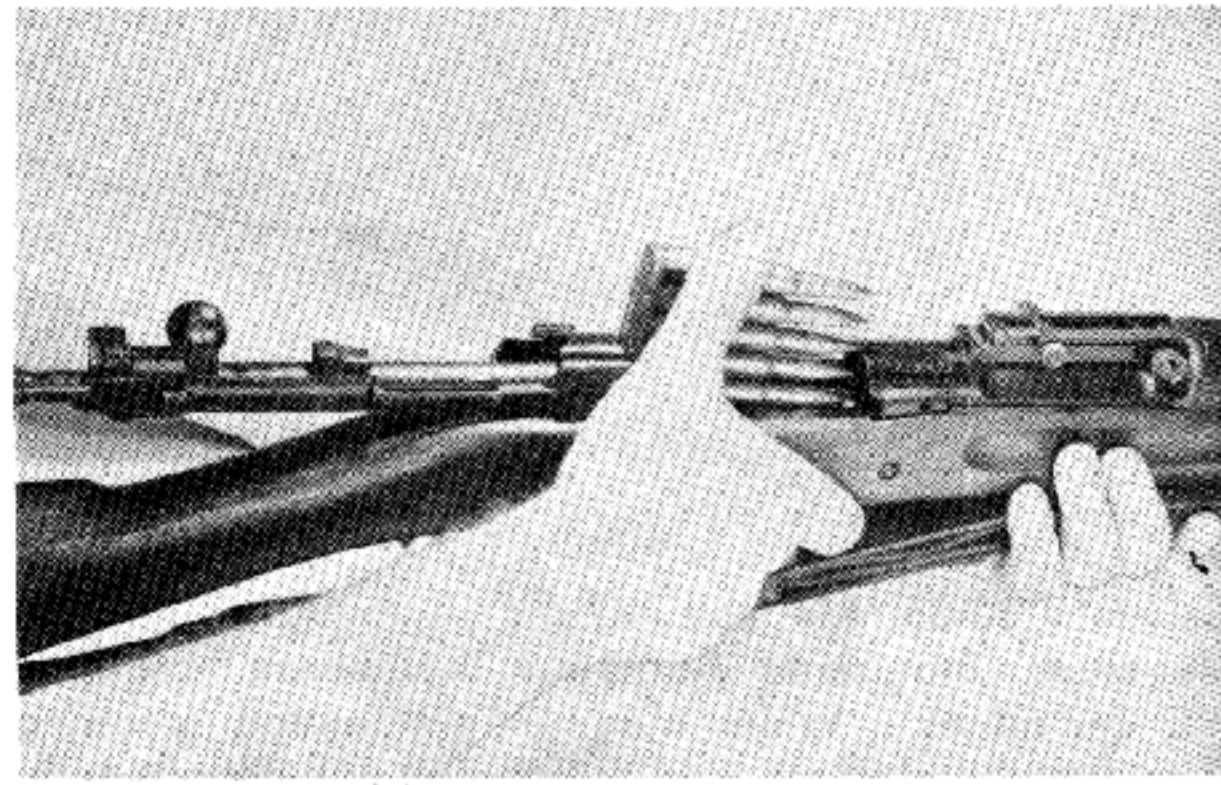

cartridge in the firing chamber, and push the bolt all the way home, turning and locking it.

Magazine cutoff may now be turned to the "Off" position and the rifle used as a single loader, with the full magazine in reserve. Magazine may be brought into play at any time by merely turning up magazine cutoff.

## SETTING THE SIGHTS ON THIS RIFLE

The elaborate sighting system of the Springfield rifle has a great deal to do with its reputation as the most accurate military rifle ever developed. Hence a somewhat detailed description of the sighting arrangement should be of general interest. The rear sight, positioned on top of the receiver over the barrel firing chamber, in the down position has an open "U" sight, called a Battle Sight, set for 530 yard range. To set the sight, the binding screw on the right hand side of the sight leaf is unscrewed so as to permit the slide to be raised up the leaf; the index line near the peep being lined up with the range lines on the sight leaf which are directly under the numbers giving the yard range.

Some sights do not have 25- and 50-yard graduation lines, and in such cases you must estimate the difference

between the 100 yard graduations on the sights. Binding screw must be screwed up tight when the index lines are properly aligned for the range at which you wish to shoot.

**Wind Gauge:** A wind gauge is provided on this sight to compensate for the drift of the bullet caused by wind. The windage screw knob is at the forward end of the sight base on the right hand side. The graduated windage indicator is at the rear end of the base. Turning the windage screw knob will turn the sighting line to right or left, one point of windage for each calibrated line. If the sight leaf moves to the right, the bullet will strike to the right; and if sight leaf moves to the left then bullet will be directed to the left.

## FIELD STRIPPING

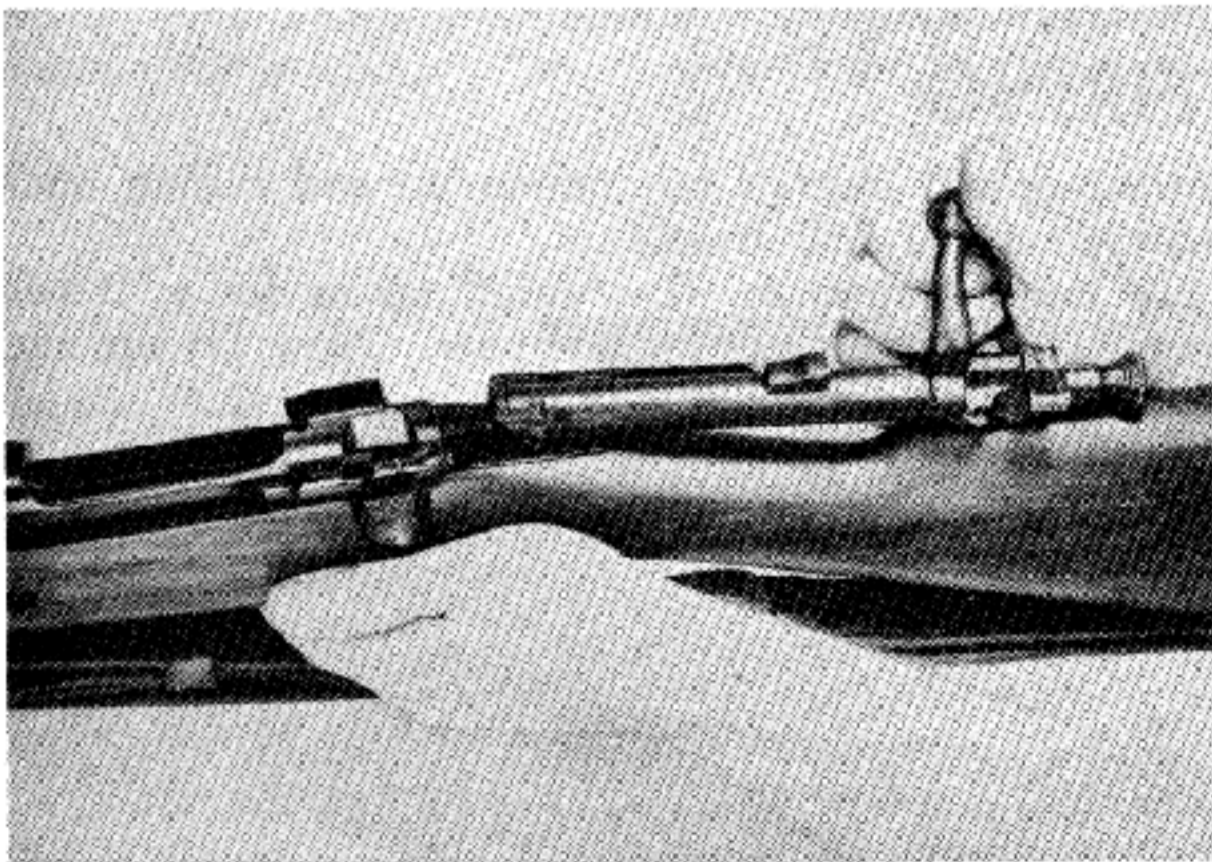

Turn the magazine cutoff to the center of the position midway between "off" and "on." Draw the cocking piece back to full cock. Turn the safety lock up to the vertical position, midway between "off" and "on." Now raise the bolt handle and draw the bolt straight back to the rear in its guide out of the receiver.

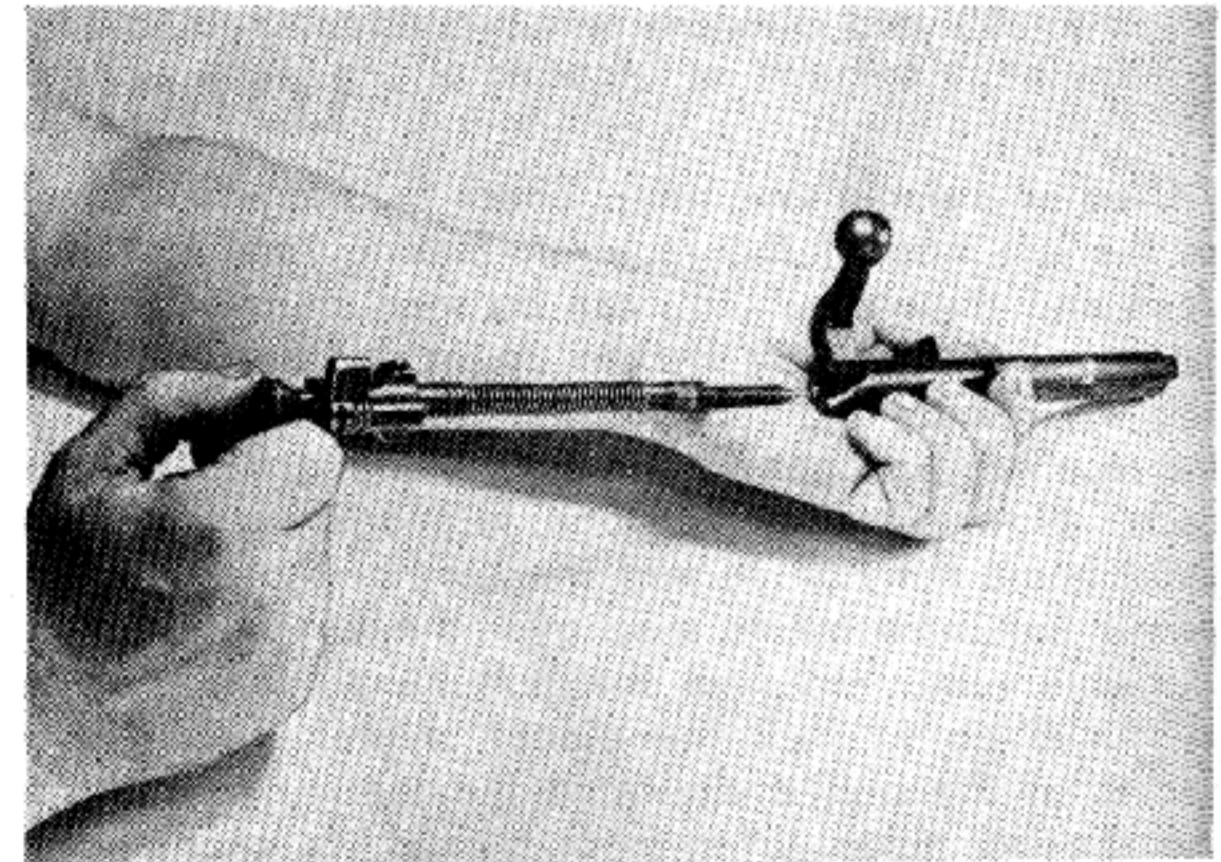

**To Dismount Bolt:** Holding bolt firmly in left hand, press in bolt sleeve lock with right thumb and unscrew, turning to the left. Bolt sleeve assembly can now be drawn back out of bolt.

Holding firing pin sleeve with left forefinger and thumb, pull back on the cocking piece with the right



# U. S. SPRINGFIELD .30-06 1903 RIFLE

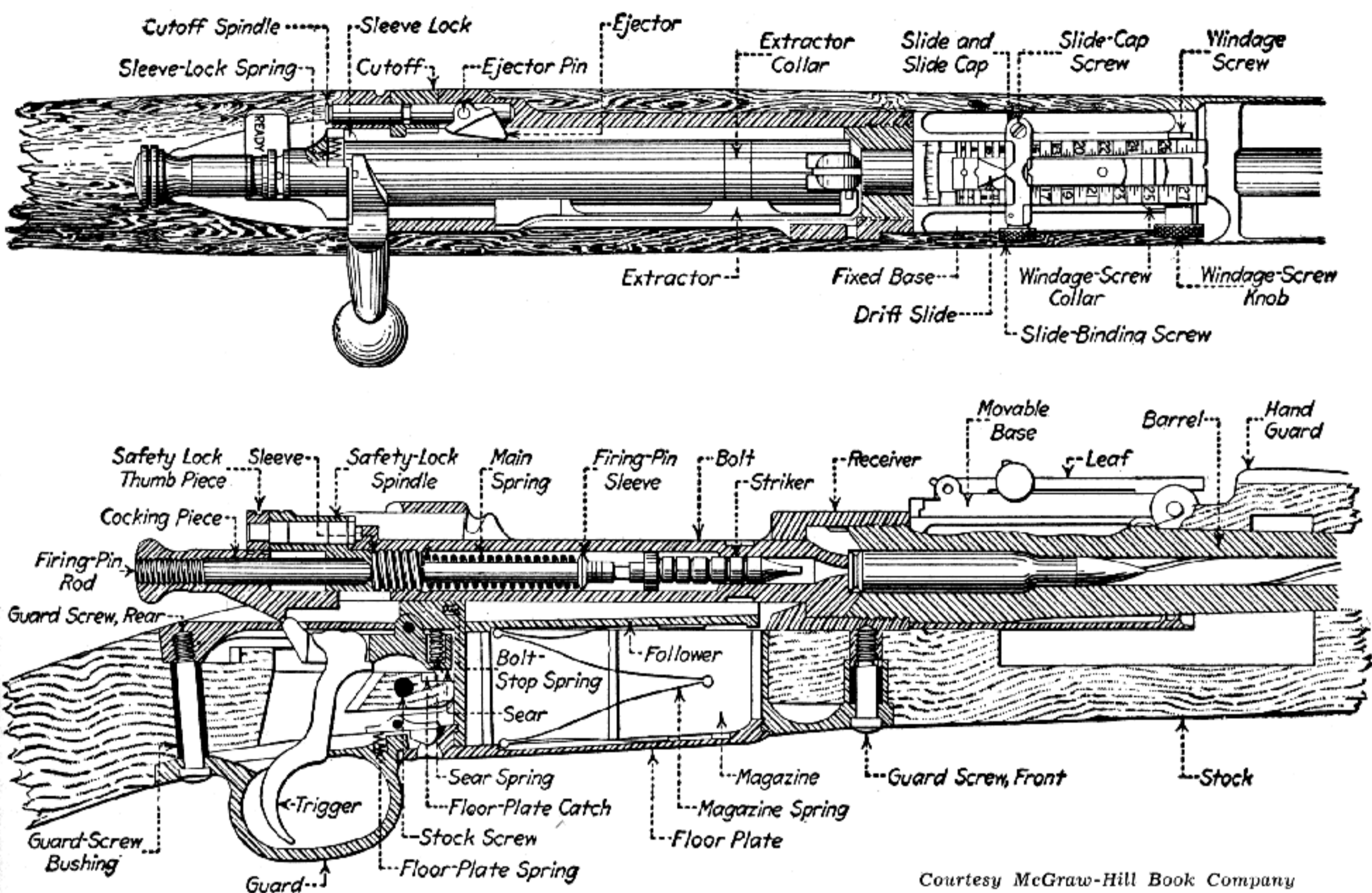

Courtesy McGraw-Hill Book Company

middle finger and right thumb, and turn the safety lock to the left with the right forefinger to release it. This will relieve part of the tension of the mainspring.

Resting the head of the cocking piece on a firm surface, pull back the firing pin sleeve and remove the striker. Firing pin sleeve, mainspring and firing pin rod may be then withdrawn.

Extractor may be removed by turning to the left, forcing tongue out of the groove in front of bolt and sliding forward.

**Assembling Bolt:** Holding bolt handle up in left hand, make sure that the extractor collar lug is in line with the safety lock on the bolt, and insert the extractor collar lug in its undercut in the extractor, then push extractor until tongue comes in contact with bolt face. Now press extractor hook against a rigid surface to bring it into its groove in the bolt.

See that the safety is down and to the left, and assemble firing pin rod and bolt sleeve. Place the cocking piece against a solid surface, draw back the firing pin sleeve and attach the striker. The firing pin must be cocked before the bolt can be screwed on. This is done by pressing the striker point against a wooden

surface (which must not be hard enough to injure it). Force the cocking piece back and engage the safety lock.

Assembled firing pin is now replaced in the bolt and screwed until the bolt sleeve lock engages.

With cutoff still turned to center notch, insert bolt in its guide in the receiver, pull down the magazine follower and push the bolt home. Now turn safety lock and cutoff down to the left, and press the trigger. PHOTO No. 6

**Stripping the Magazine:** Turn rifle upside down, insert nose of bullet in the hole in the rear of the bottom plate to depress the spring catch.

Retaining pressure, pull back towards the trigger guide; which will release the spring and the magazine follower, and permit them to be removed from the weapon.

**Assembling:** When assembling the magazine, make sure the front end of the bottom plate catches on the front end of the magazine opening and push it down and forward until the spring catch engages.

No further stripping of this weapon is necessary or desirable.



# U. S. RIFLE .30 M1

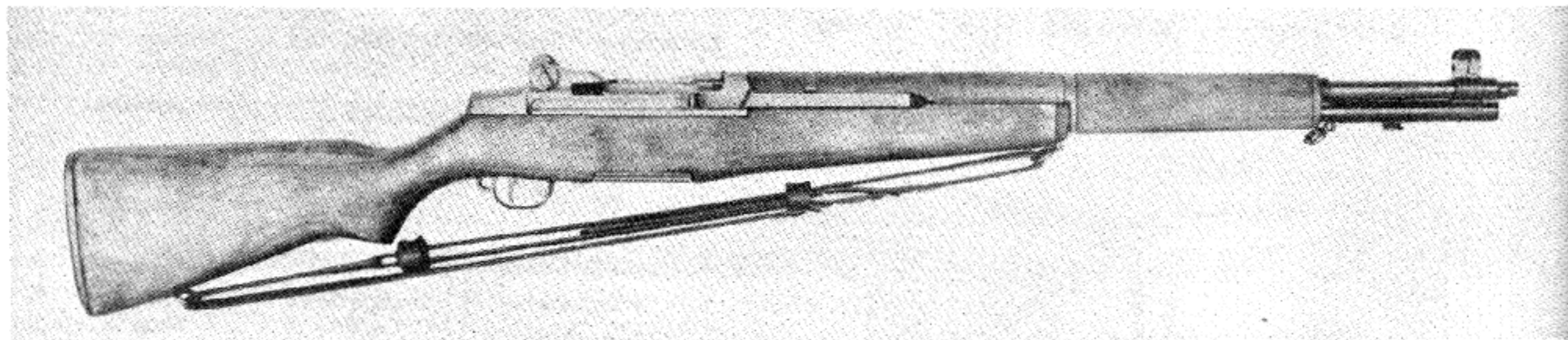

## (Garand Semi-Automatic Rifle)

**Caliber:** .30 U. S.

**Magazine:** Fixed box type in receiver loaded with clip.

**Cartridge Clip:** Capacity 8 rounds. Note that this is not the Springfield type. The Garand clip is inserted in the Rifle with the cartridges.

**When Last Shot Has Been Fired:** Empty cartridge clip is expelled through top of the Rifle.

**Ballistics:** Standard for cartridges employed.

**Barrel Length:** 2' 3".

**Overall Length of Gun:** 3' 7"

**Weight of Gun:** 9 1/2 lbs. (with bayonet 1 lb. more.)

**Sights:** Aperture. Adjustable from 200 to 1200 yards.

**Rifle Operated by:** Gas. As bullet leaves barrel, a small quantity of gas escapes through a port into the gas cylinder where it forces back a piston under the barrel, compresses the recoil spring, extracts and ejects the empty cartridge case and cocks the weapon. As the return motion ends, the spring forces the action forward loading the firing chamber.

**Locked:** By rotating bolt with two lugs which fit into recesses in the receiver.

**Cooled:** No cooling device. However, the barrel in this rifle is much heavier than in our other military rifles.

**Cyclic Rate of Fire:** Around 800 per minute.

**Position of Operating Rod Handle When Weapon is Ready To Fire:** Fully forward. This gun fires from a closed bolt.

**Type of Fire:** Single shot only. This is a semi-automatic rifle. It is impossible to fire more than one shot for each pull of the trigger.

**Ejection:** Empty cartridge cases are ejected on the right upwards and to the front. When rifle is empty, bolt will stay open. This serves notice that the weapon is empty and permits immediate insertion of a fully loaded clip, so that firing may be speedily resumed.

**Loading and Firing: Gas Ports:** In early models, port is in a sleeve in front of the barrel muzzle. In later models, the port is bored in the barrel.

## LOADING AND FIRING

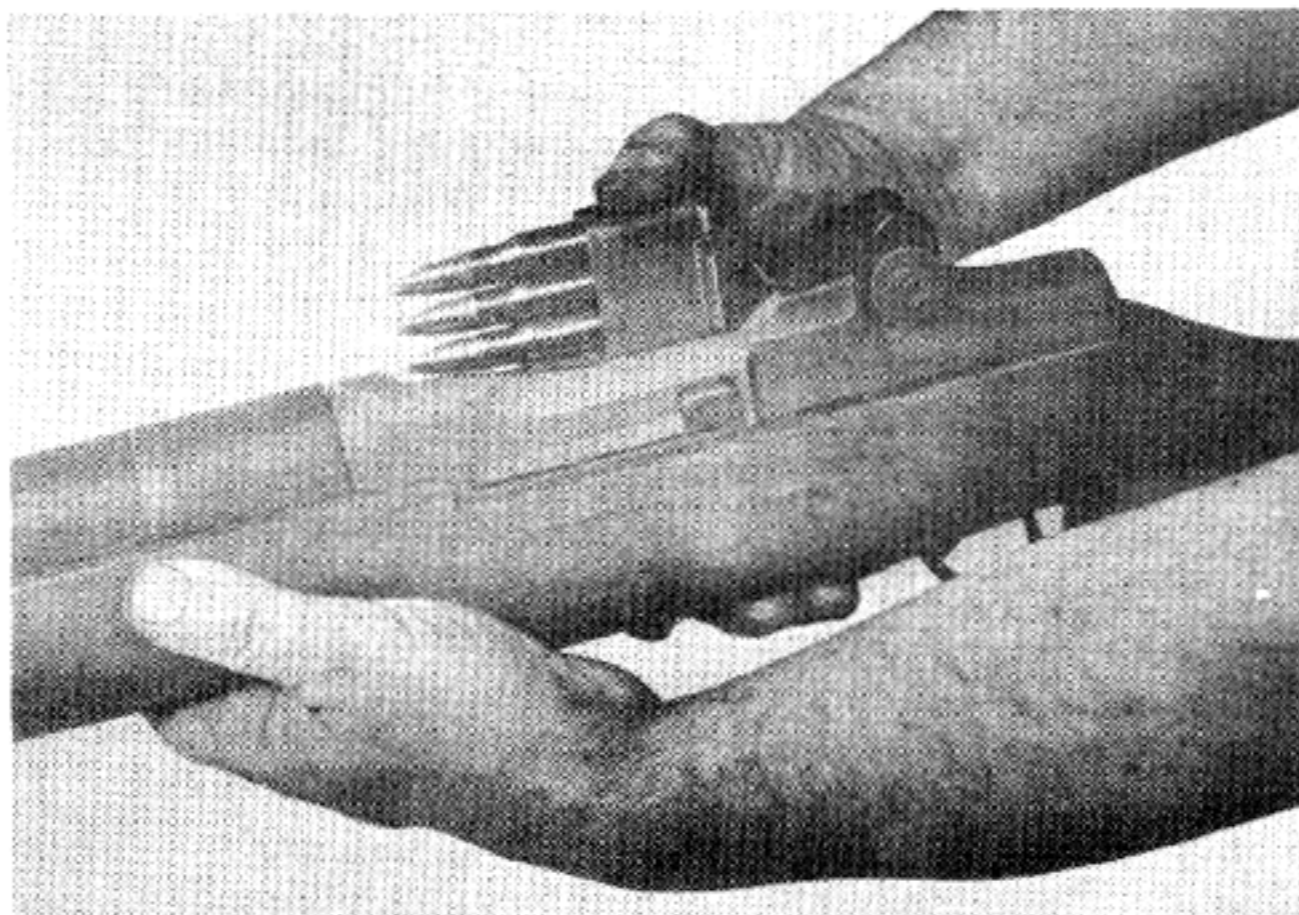

Grasping the rifle at the balance with the right hand, with the right forefinger, pull operating rod straight to the rear. It will be caught and held open by the operating rod catch.

2. Place the loaded clip on top of the magazine follower; and with right side of right hand against the operating rod handle press down with right thumb on the clip until it is caught in the receiver by the clip latch.

3. Remove the right thumb from the line of the bolt and let go of the operating rod handle which will run forward under the compression of the spring. Push op-

erating rod handle with heel of right hand to be certain that bolt is fully home and locked.

4. Pressing the trigger will now fire one cartridge. Weapon will be ready for the next pull of the trigger.

5. If weapon is not to be used at once, set the safety. The safety is in front of the trigger guard. Pulling it back towards the trigger sets it on safe; while pushing it forward is the fire position.

Note that the cartridge clip is reversible and may be fed into the rifle from either end.



# U. S. RIFLE .30 M1

## UNLOADING THE GARAND RIFLE

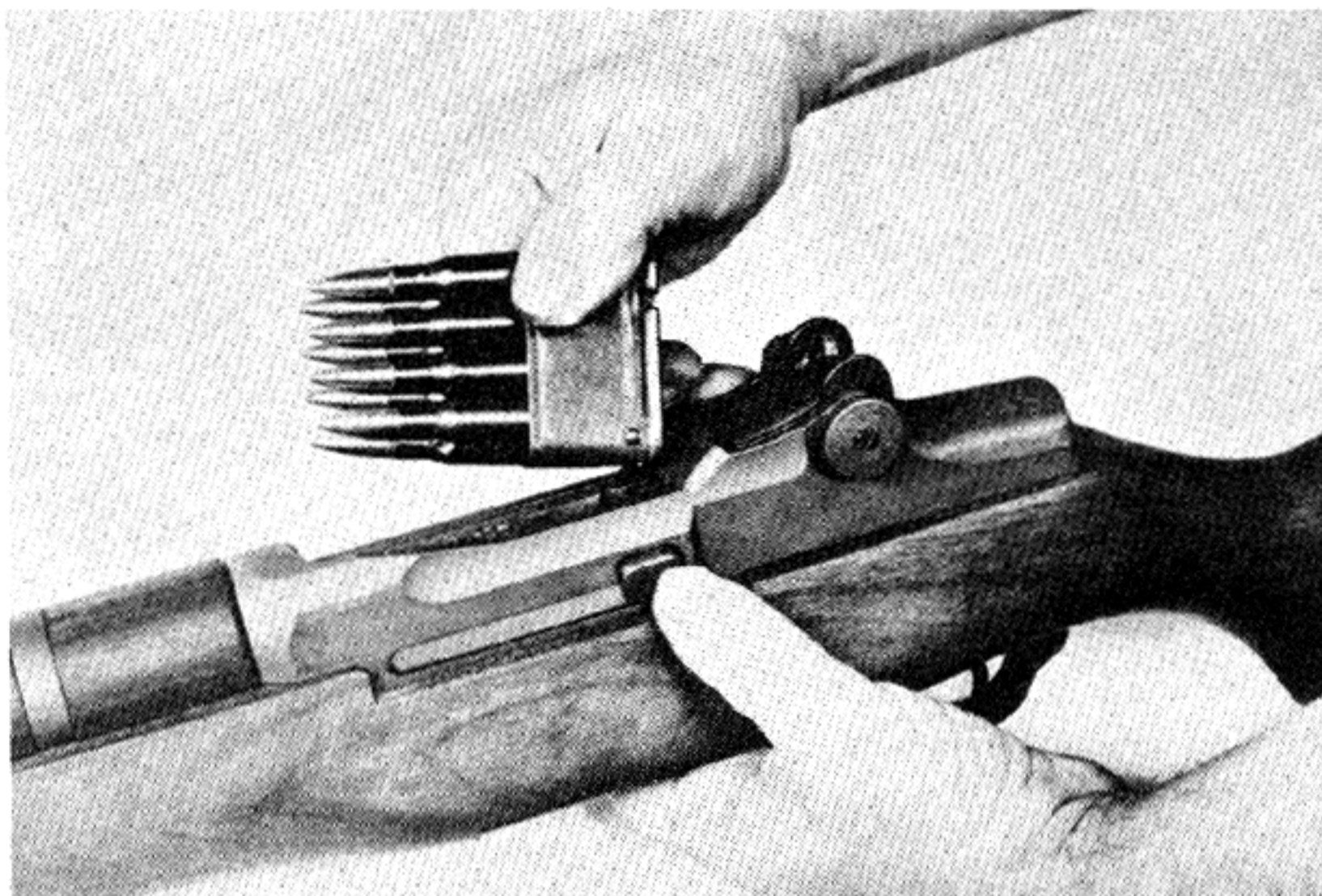

1. First check to be sure that the safety is off.
2. With the right forefinger pull the operating rod back sharply and hold it in rear position. This will eject the cartridge that was in the firing chamber. With the fingers of the hand grasp the trigger guard or the grip firmly. Hold the stock against the right hip to support it. Then place the left hand over the receiver and with the left thumb release the clip latch.
3. The clip and whatever cartridges remain in it will now pop up into the right hand and must be removed from the rifle.
4. With the right side of the right hand held against the operating rod handle, force the operating rod

slightly to the rear. With the right thumb now push down the magazine follower and permit the bolt to move forward about an inch over the end of the follower.

5. Remove the thumb smartly from the follower and let go of the operating rod handle. The action will close under the tension of the spring. Now press the trigger.

6. If you wish to unload the firing chamber but leave the magazine loaded, pull the operating rod back as described above to eject the cartridge from the firing chamber; then pull the operating rod handle back past its normal rear position, force the clip down, ease the rod far enough to let the bolt handle ride over the top of the clip, then let operating rod go forward.

### FIELD STRIPPING

(Note: A thorough knowledge of field stripping is necessary in order to give the Rifle the care essential to its correct operation.)

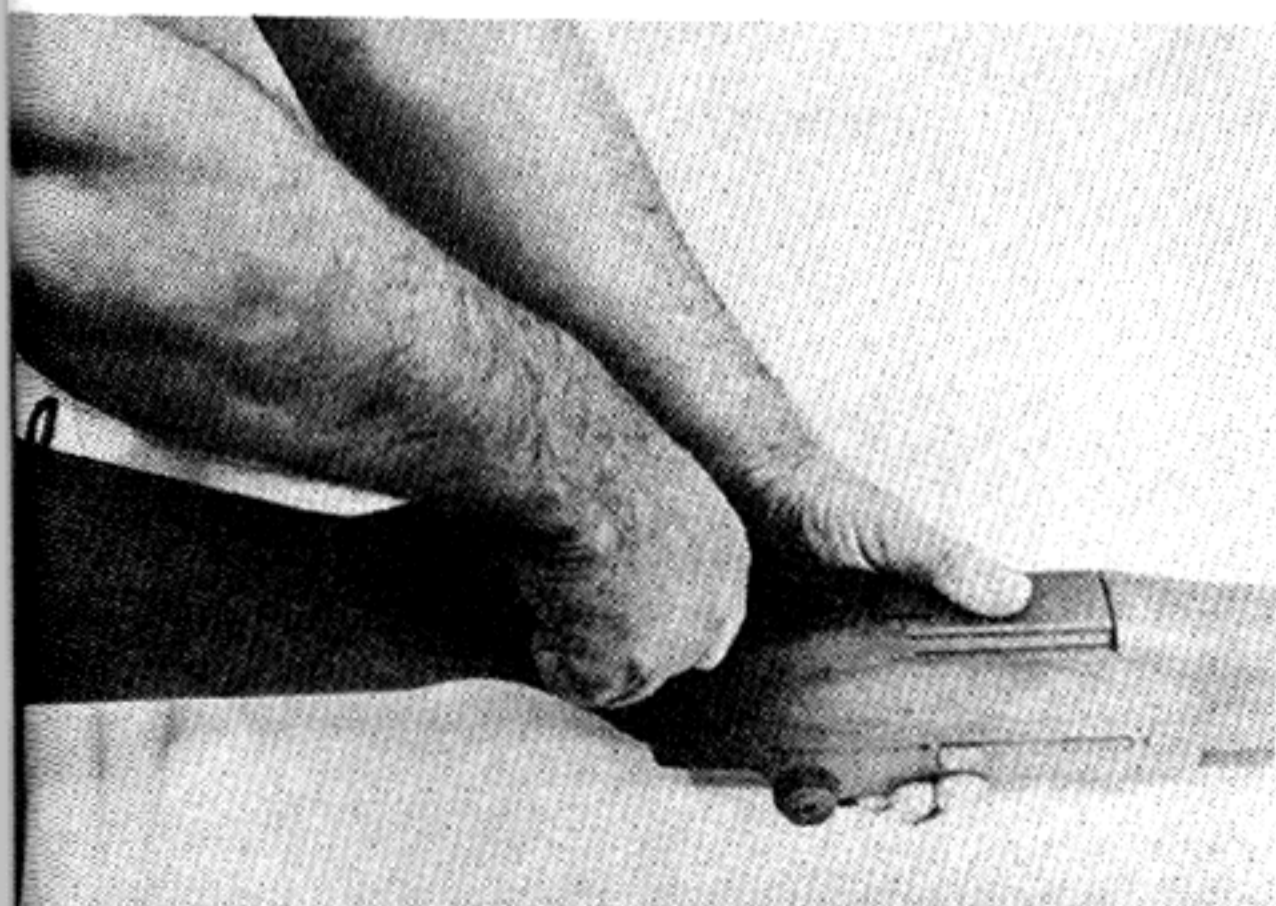

1. Start by placing the rifle upside-down on a firm surface. Holding the rifle with left-hand, fingers firmly holding the base of the trigger housing, rest the butt against the left thigh.

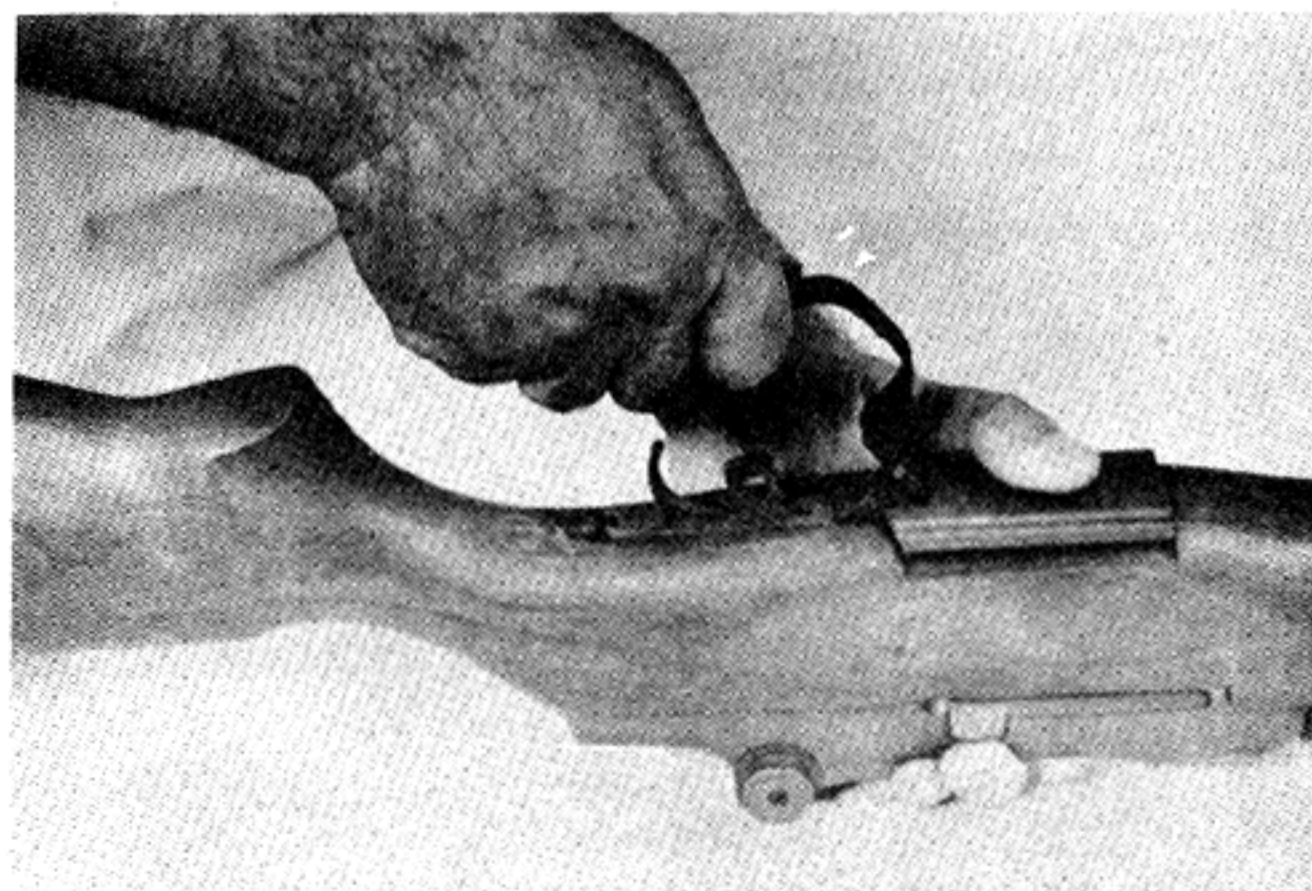

2. With thumb and forefinger unlatch the trigger guard by pulling back on it.



# U. S. RIFLE .30 M1

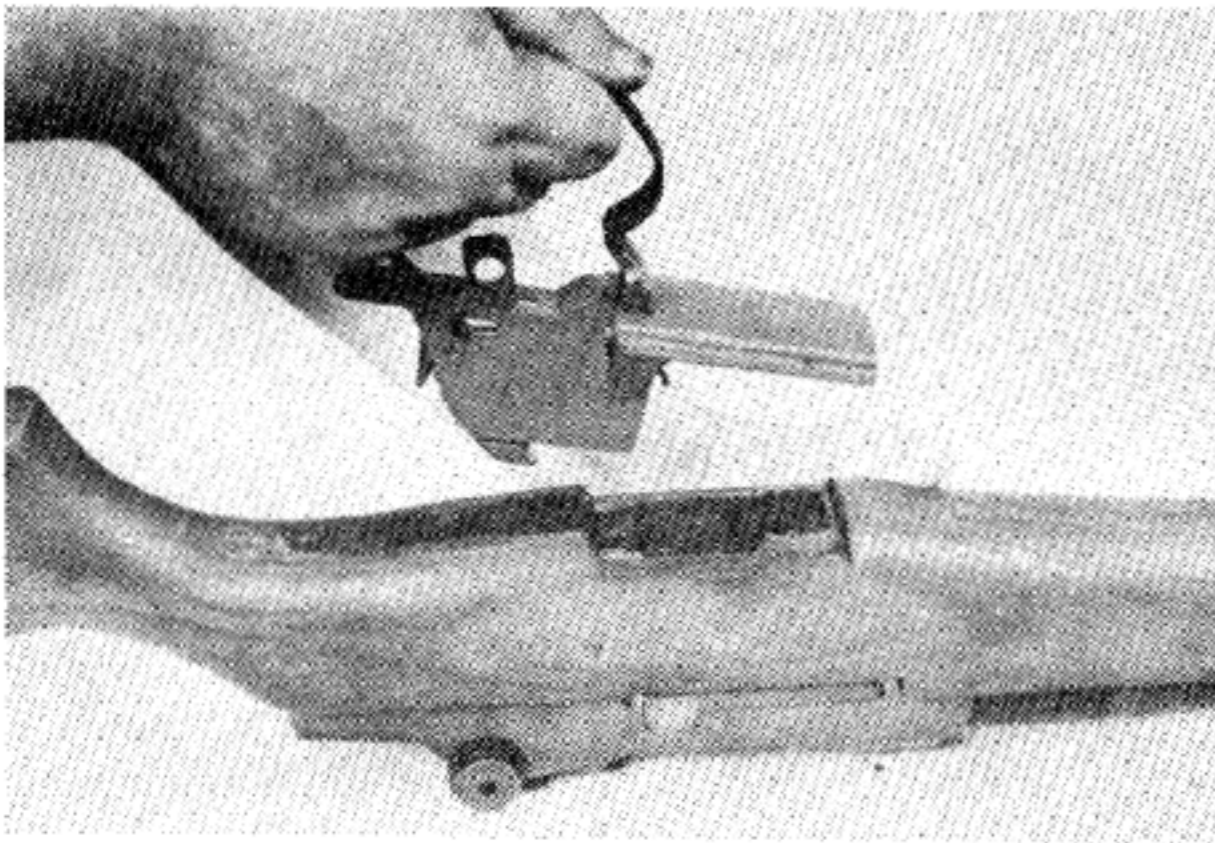

3. Continue the pressure and pull out the trigger housing group.

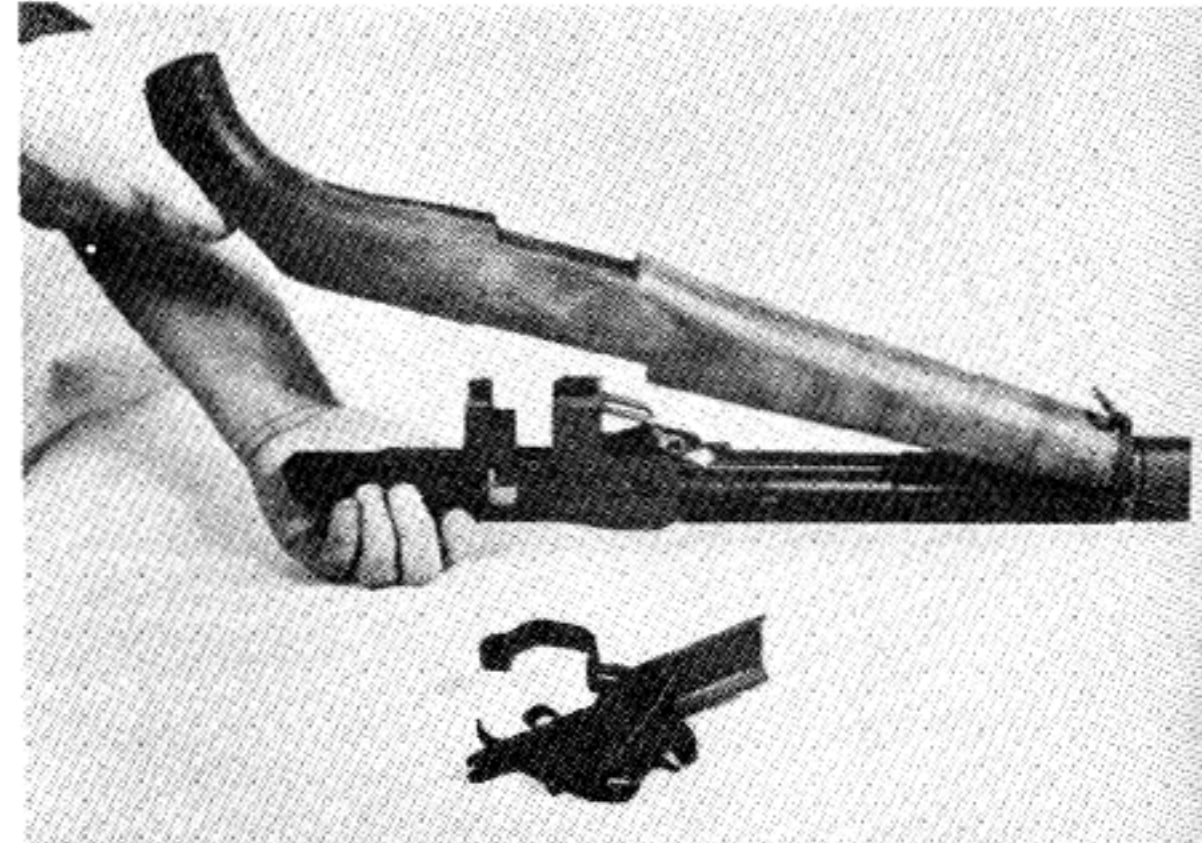

4. With left-hand now grasp rifle over rear sight holding the muzzle down and the barrel to your left. With right-hand strike down against the small of the stock, firmly grasping it at the same time. This will separate the barrel and receiver group from the stock group.

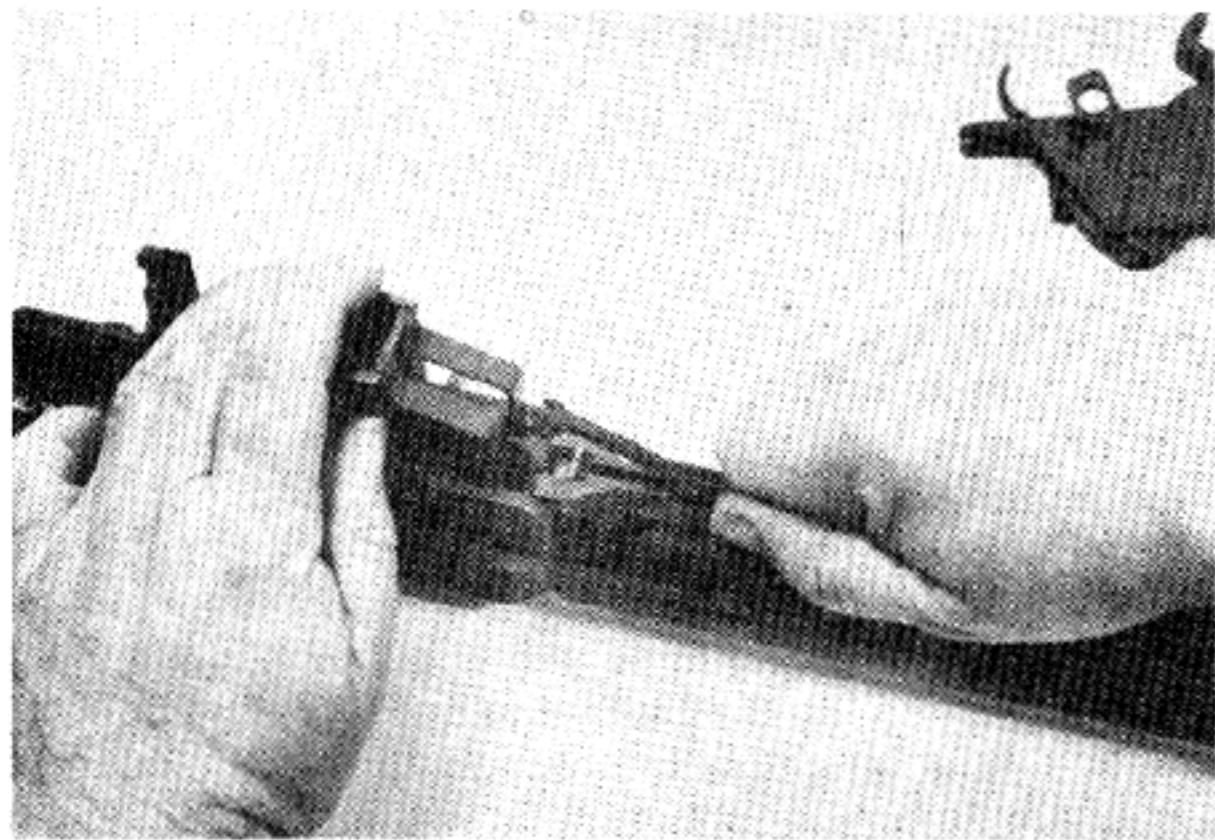

## TO DISMOUNT BARREL AND RECEIVER GROUP:

1. With the barrel down, grasp the follower rod at the knurled portion with thumb and forefinger and press it toward the muzzle to free it from the follower rod.

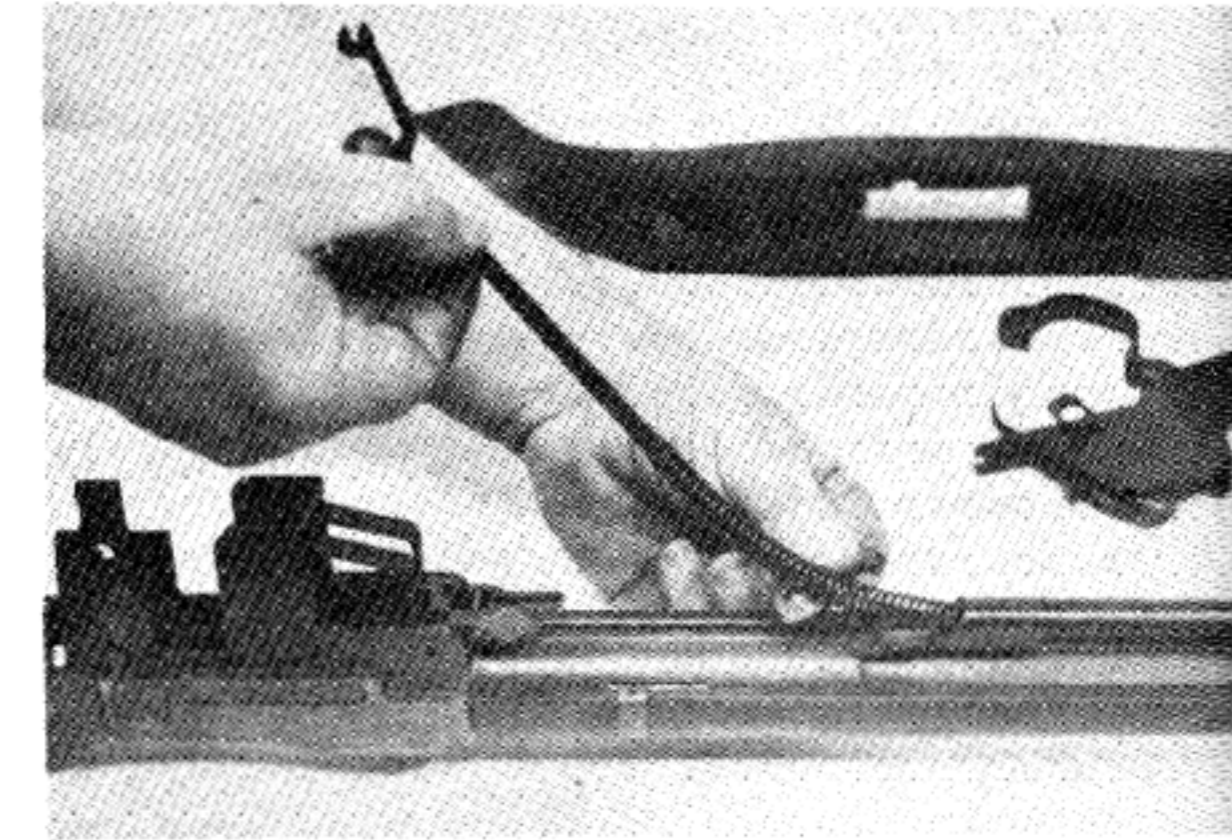

2. The follower rod and its compensating spring which is attached may now be withdrawn to the right. The compensating spring is removed from the follower rod by holding spring with left-hand and twisting rod toward the body with the right-hand meanwhile pulling slightly to the right.

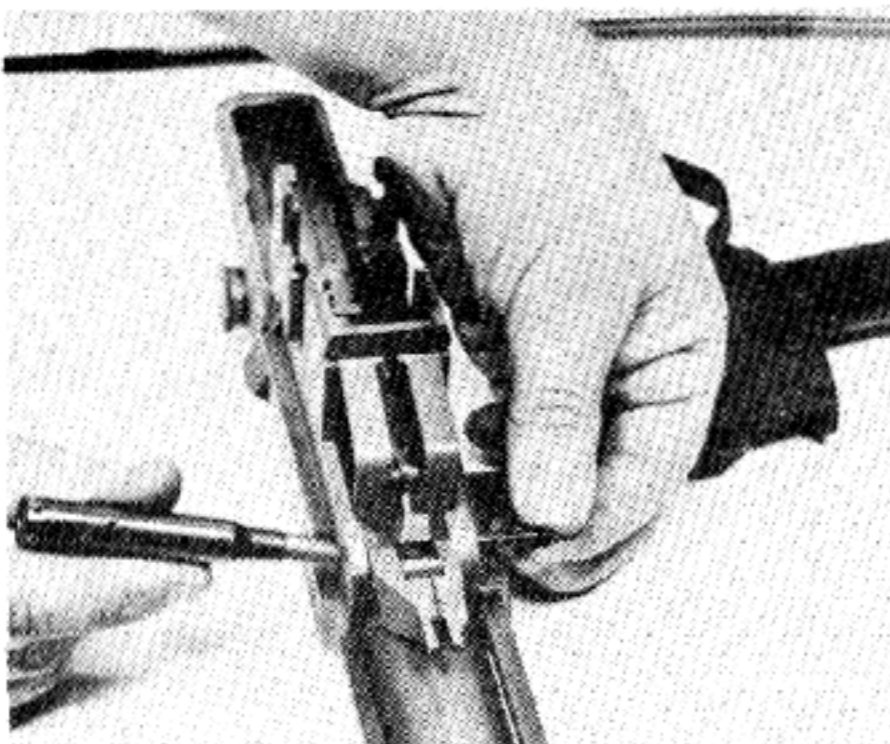

3. With the point of a bullet, push the follower arm pin from its seat and pull it out with the left-hand.

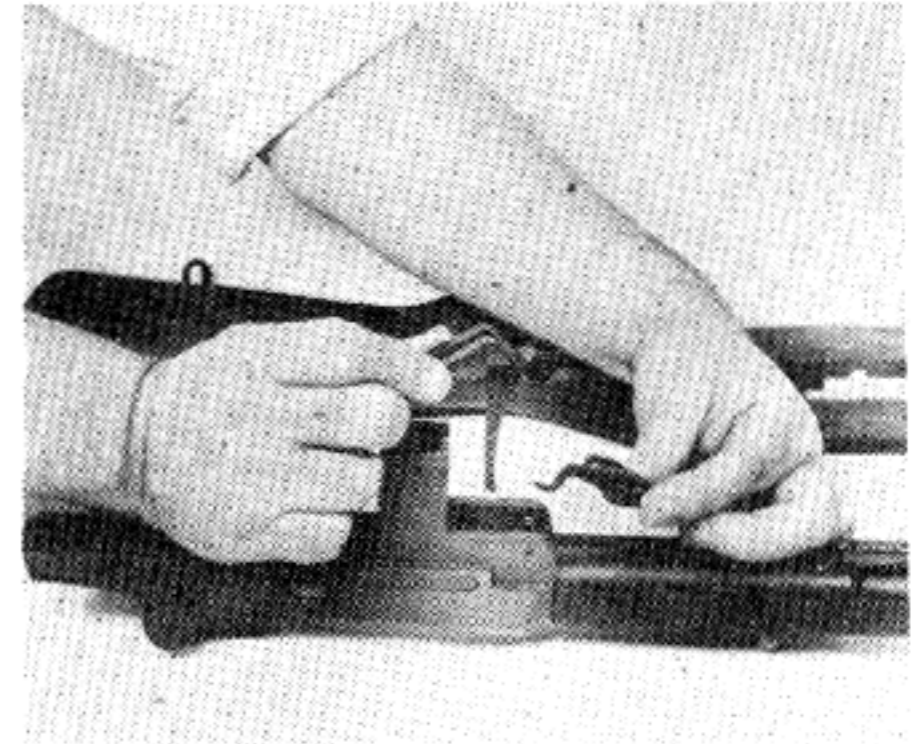

4. Seize the bullet guide, follower arm, and operating rod catch assembly; draw these to the left until they disengage. The three separate parts may now be lifted out. (Accelerator pin is riveted in its seat, so do not attempt to remove accelerator from operating catch assembly.)



# U. S. RIFLE .30 M1

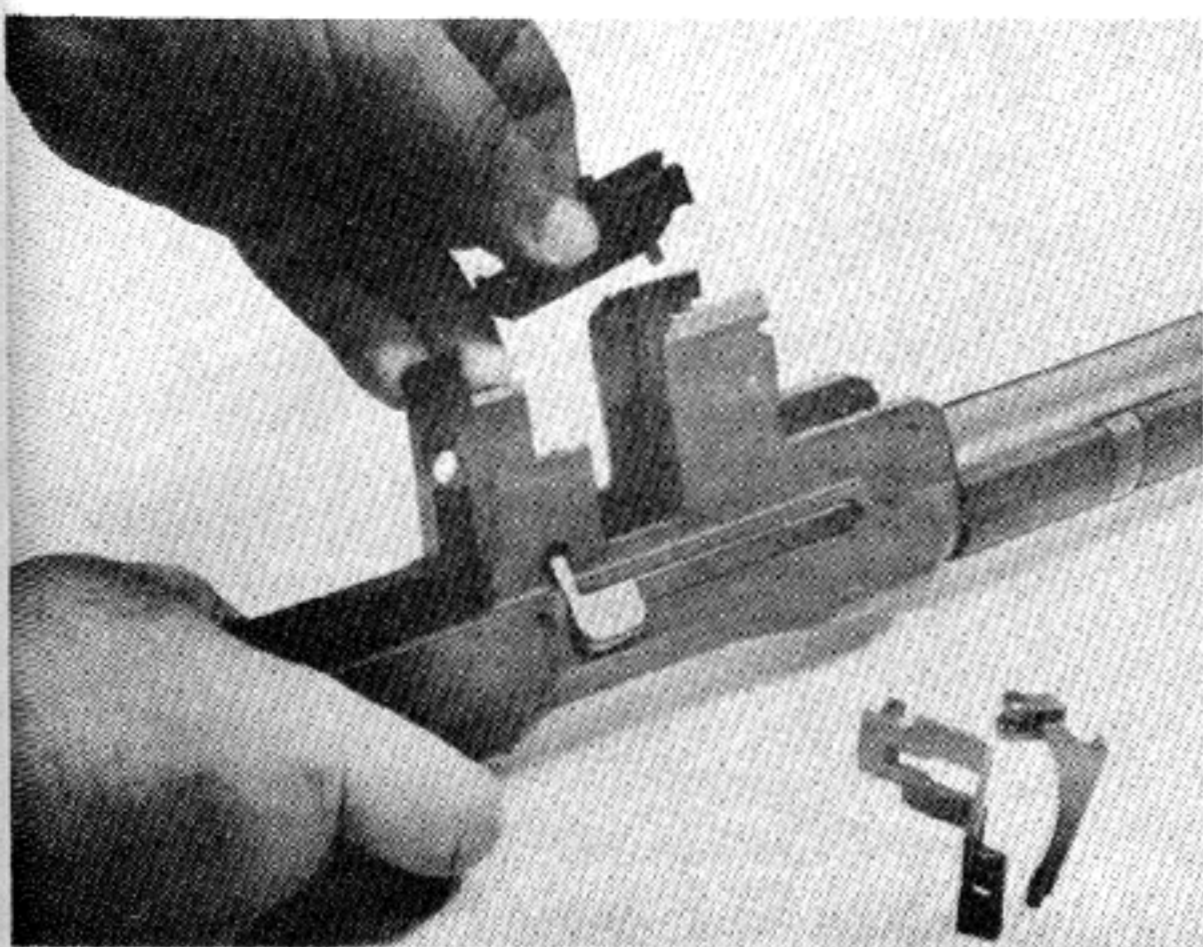

5. Lift out follower with its slide attached (do not separate follower from slide.)

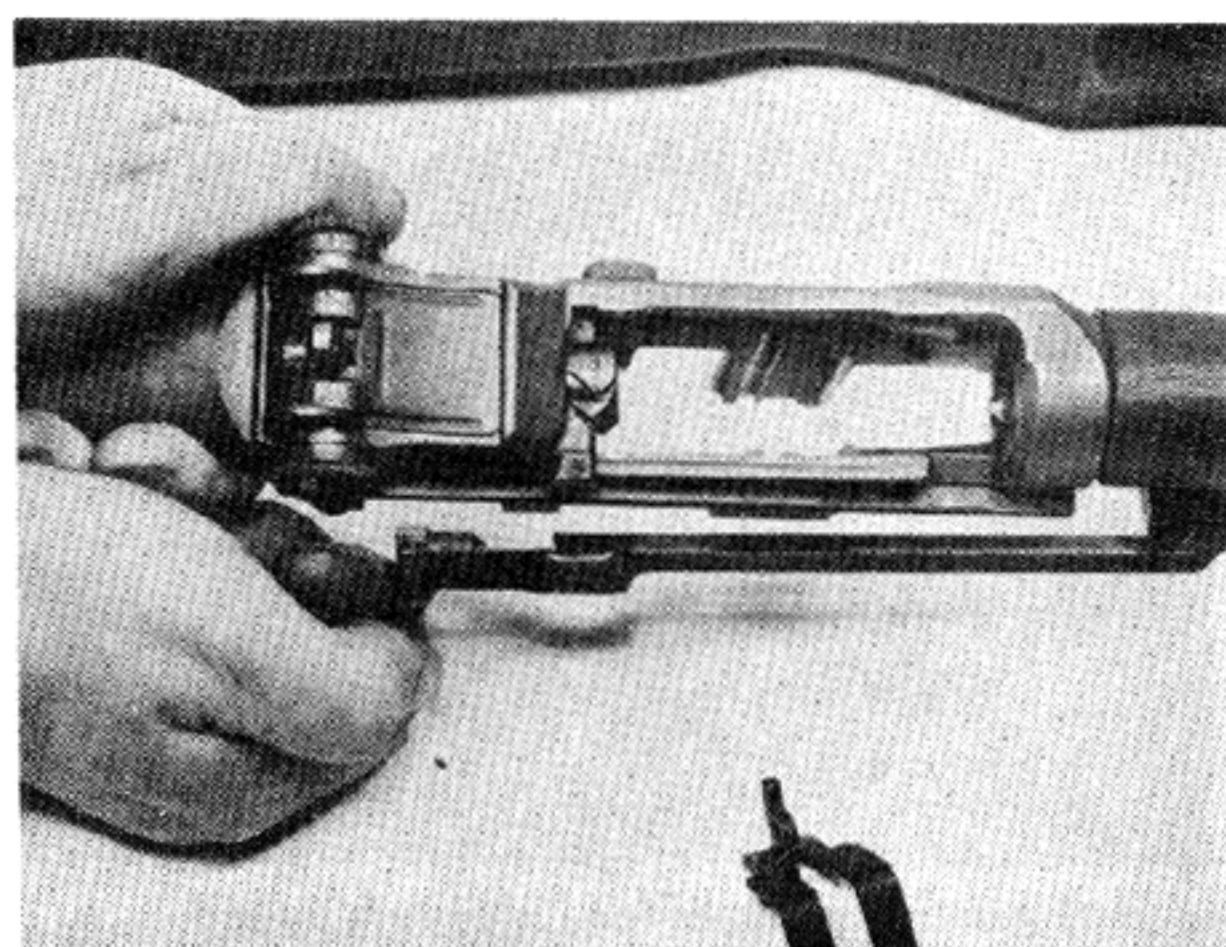

6. Holding barrel and receiver assembly with left hand, grasp the operating rod handle with right hand and move it slowly to the rear, meanwhile pulling the rod handle up and away from the receiver. (This disengages operating rod from bolt, when the lug on the operating rod slides into the dismount notch of the operating rod guide groove.) When operating rod is disengaged pull it down and back and withdraw it. (Note that the operating rod is bent. This is intentional. Do not attempt to straighten it.)

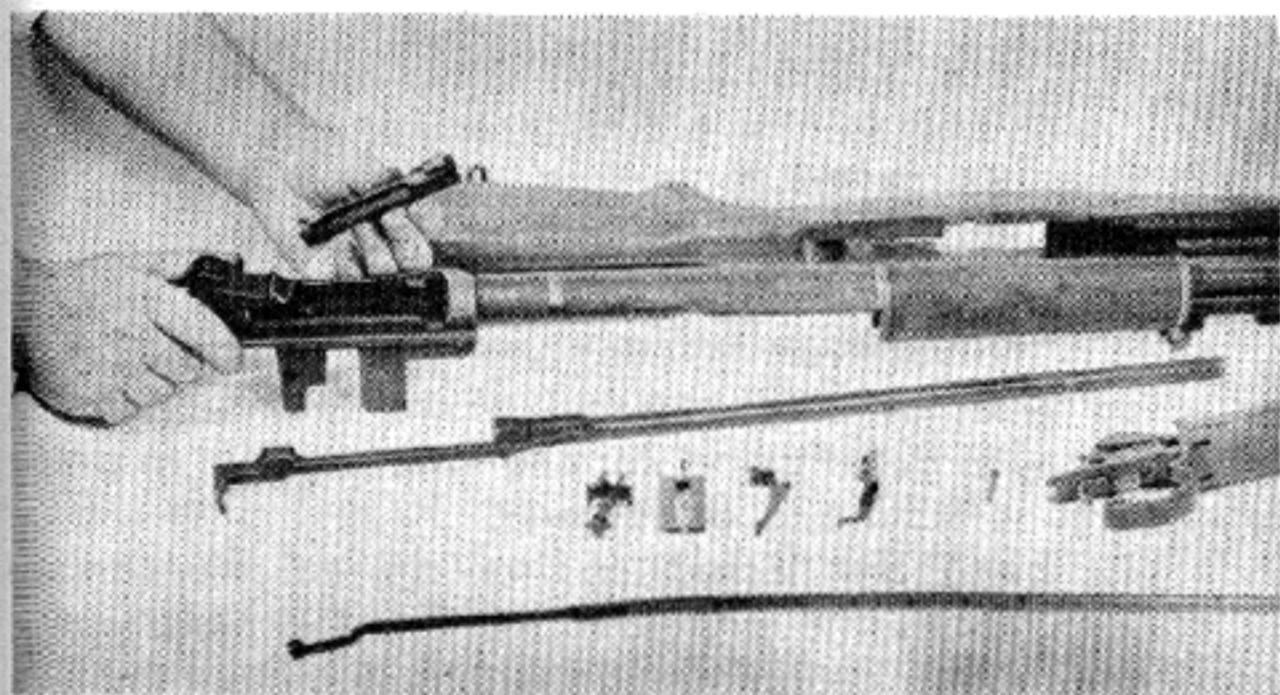

7. Slide the bolt from the rear to the front by pushing the operating lug on it, and lift it out to the right front with a slight twisting motion.

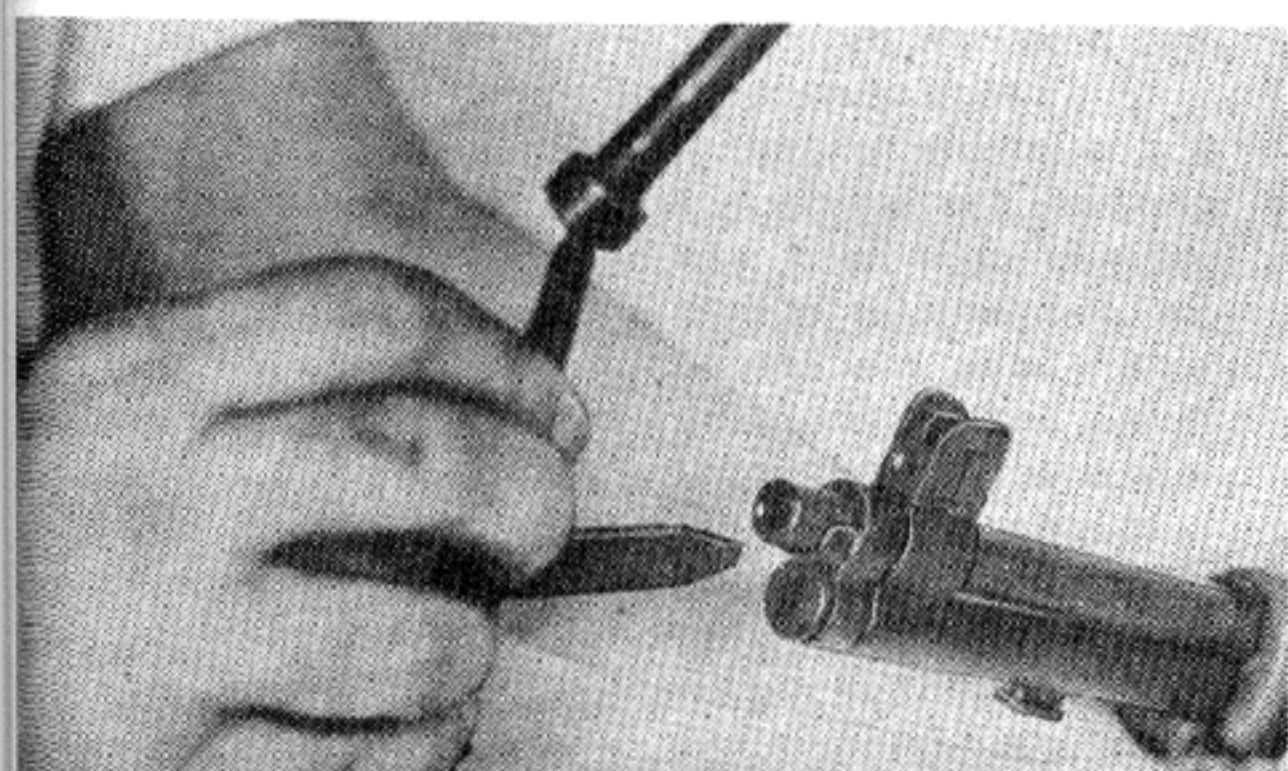

**Note on Gas Cylinder:** 1. In the older type of M-1 Rifle, the barrel does not protrude and front side screw enters from the side. This is the screw-on type. Remove the front sight screw and lift it out. Gas cylinder assembly may now be unscrewed from the barrel.

2. In later models M-1 a spline-type gas cylinder is used in which the barrel protrudes beyond the cylinder. The front sight screw is entered from the front in this type and it is sealed to prevent unscrewing.

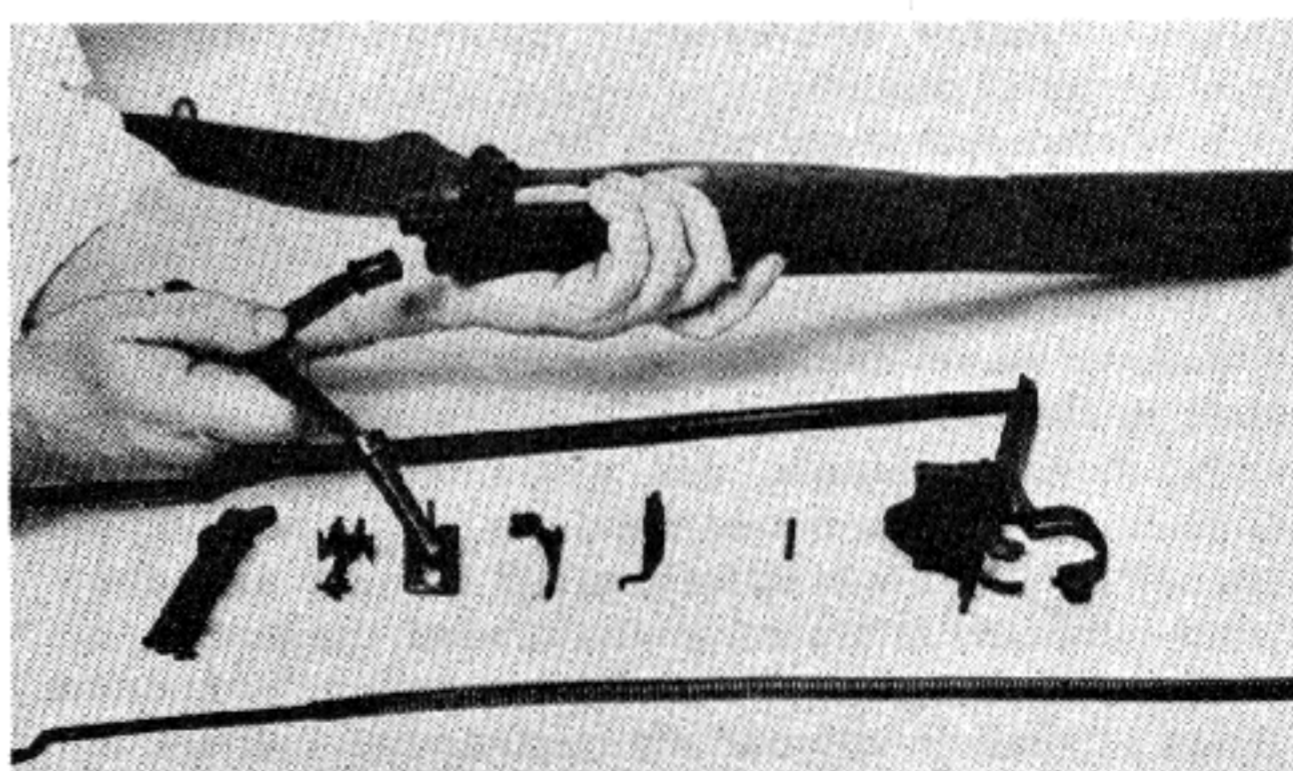

3. The combination tool must be used on this type to unscrew the gas cylinder lock screw.



# U. S. RIFLE .30 M1

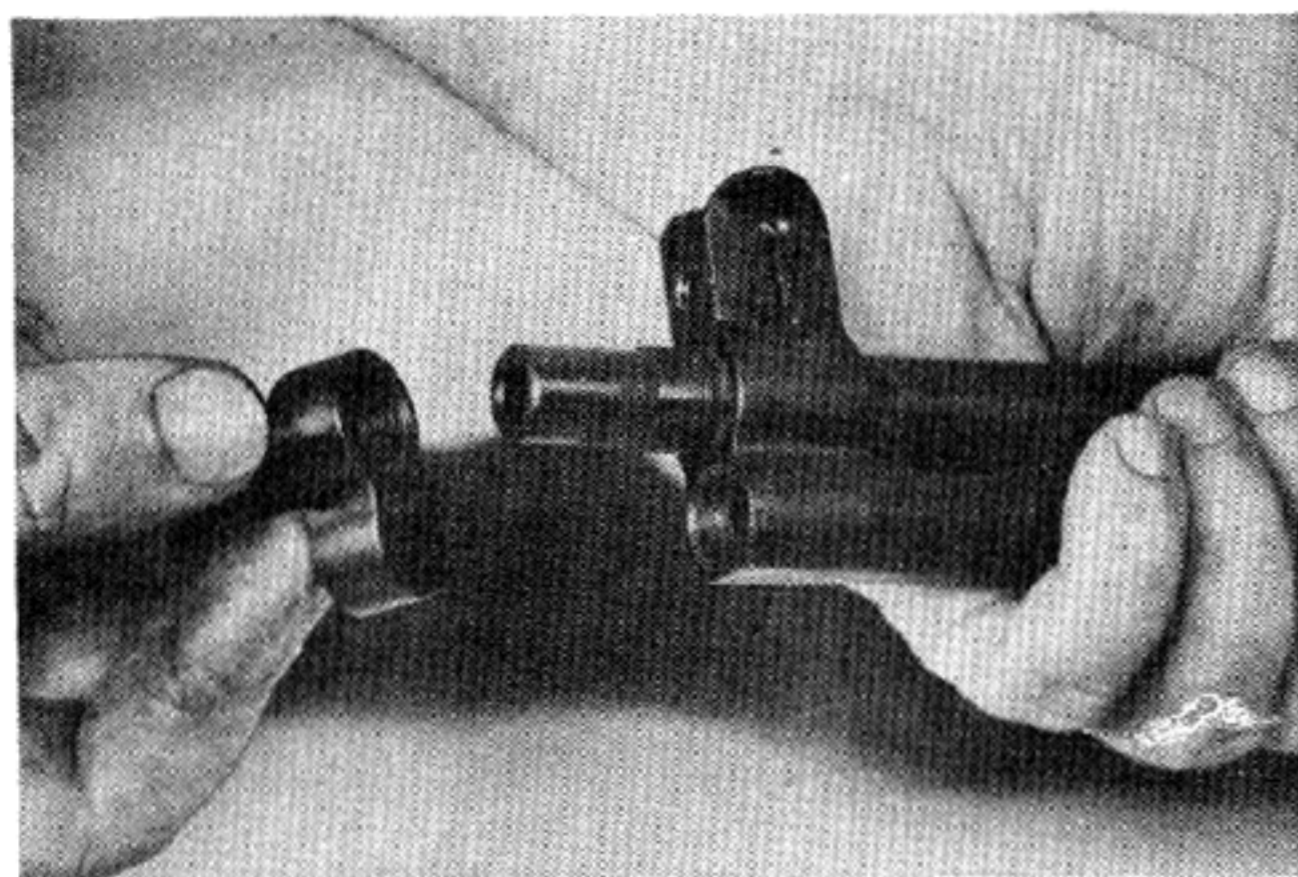

4. Next the gas cylinder lock is unscrewed.

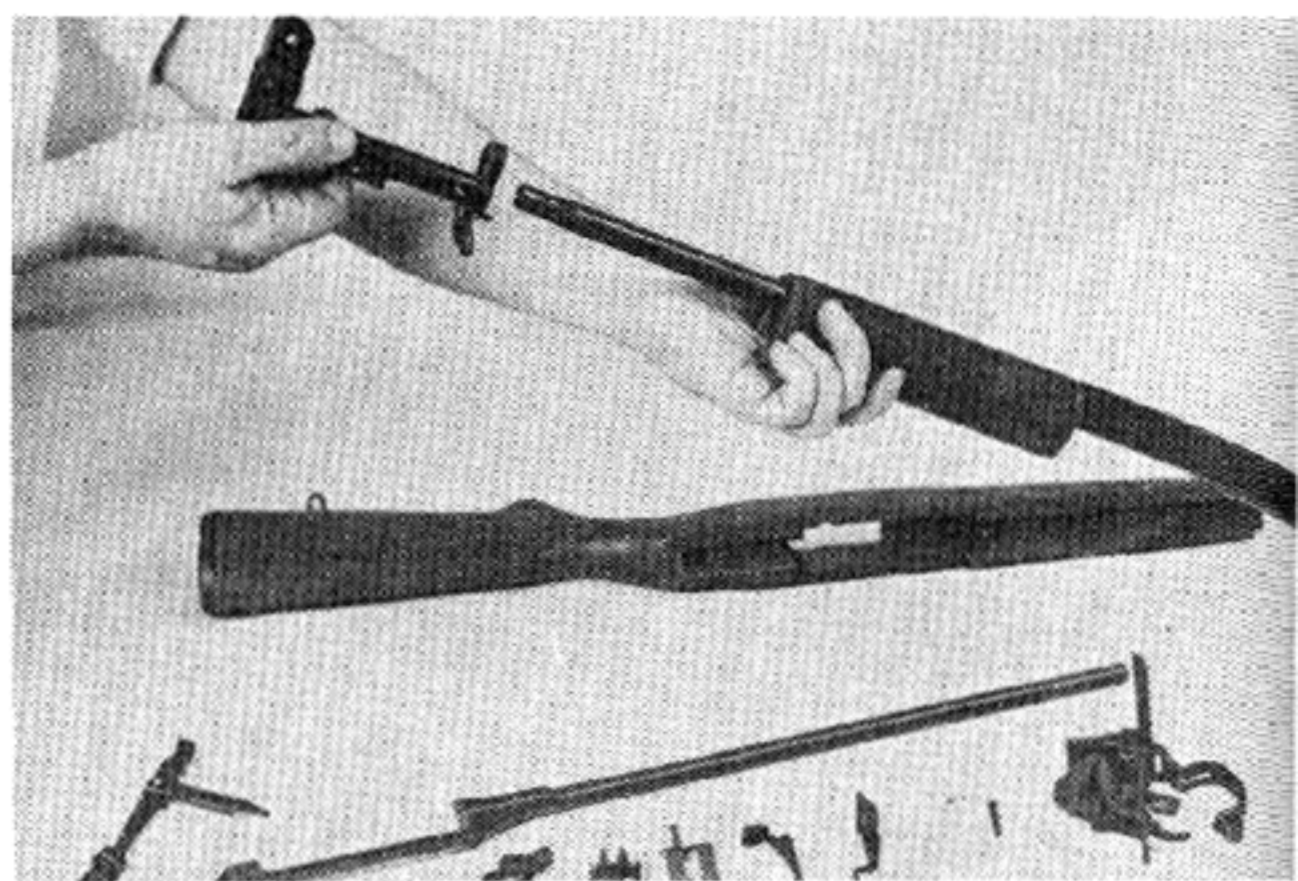

5. The gas cylinder is tapped towards the muzzle and removed from the barrel. The front sight will not dismount from gas cylinder assembly in this type.

6. Gas cylinder assembly should never be removed except when necessary to replace the front hand guard assembly.

## ASSEMBLING THE M-1 RIFLE

1. Replacing gas cylinder, if it has been dismantled, is done by merely reversing the dismantling procedure.

2. To assemble barrel and receiver group: Tilt the barrel and receiver assembly, sight up and muzzle to the front to an angle of about 45°.

3. Holding the bolt by the right locking lug so the front end of the bolt is somewhat above and to the right of its extreme forward position in the receiver, insert the rear end in its bearing on the bridge of the receiver. Switch it from right to left far enough to let tang of the firing pin clear the top of the bridge. Next guide the left locking lug of the bolt into its groove just to the rear of the lug on the left side of the receiver, and start right locking lug into its bearing in the receiver. Now slide bolt back to its extreme rear position.

4. Turn barrel and receiver assembly in left hand until barrel is down.

5. Grasp operating rod at the handle and holding it handle up, insert piston head into gas cylinder about  $\frac{3}{8}$ ". Be sure that operation rod handle is to the left of the receiver.

6. Hold barrel and receiver assembly in left hand and twist to the right until barrel is uppermost.

7. Adjust operating rod with right hand so that camming recess on its rear end fits over operating lug on bolt. Now press operating rod forward and downward until bolt is seated in its forward position.

8. With barrel and receiver assembly held barrel down and muzzle to your left, replace the follower with its attached slide so that its guide ribs fit into their grooves in the receiver. (The square hole in the follower must be to the right.) The follower slide rests on the bottom surface of the bolt when the follower is in the correct position.

9. With left hand replace bullet guide fitting the shoulders of the guide into their slots in the receiver

and the hole in the projecting lug is in line with the hole in the receiver.

10. With left hand replace follower arm passing stud end through bullet guide slot and inserting stud in proper grooves in front end of follower.

11. Place the forked end of the follower arm in position across the projecting lug on the bullet guide with pin holes properly aligned.

12. Insert rear arm of operating rod catch into clearance cut in the bullet guide (be sure its rear end is below the forward stud of the clip latch which projects into the receiver mouth). Line up the holes in the operating rod catch, the follower arm and the bullet guide with those in the receiver; and insert the follower arm pin in the side of the receiver towards your body and press the pin home.

13. Insert operating rod spring into operating rod; and assemble follower rod and compensator spring by grasping the spring in left hand and inserting follower rod with right hand, and twisting the two together until the compensator spring is fully seated.

14. Seize the knurled portion of follower rod with thumb and forefinger of left hand with hump down and forked end to the right.

15. Place left end of follower rod into operating rod spring and push to the left; seating the forked end against the follower arm.

16. Insert U shaped flange of stock ferrule in its seat in the lower band.

17. Pivoting about this group, guide chamber and receiver group and press into position in the stock.

18. Replace trigger housing group with trigger guard in open position into the stock opening.

19. Press into position, close and latch trigger guard. This completes reassembly.



# U. S. RIFLE .30 M1

## HOW THE U. S. RIFLE M-1 WORKS

**Starting with the rifle loaded and cocked the action is as follows:** The trigger being pressed, the hammer strikes the firing pin, exploding the cartridge in the chamber. As the bullet passes over the gas port tapped in the under side of the barrel, some of the gas escapes into the cylinder and blasts back against the piston and operating rod with force enough to drive the rod to the rear and compress the return spring.

During the first 5/16" of rearward travel the operating lug slides in a straight section of the recess on the operating rod; after which the cam surface of this recess is brought in contact with the operating lug which it cams up, thereby rotating the bolt from right to left to unlock its two lugs from their recesses in the receiver.

During the moment of delayed action, the bullet leaves the barrel and the breech pressure drops to a safe point. The further rotation of the bolt then cams the hammer away from the firing pin and pulls the firing pin back from the bolt. The operating rod continues its backward movement carrying the bolt with it as the lug on the bolt has reached the end of its recess.

During this rearward motion of the bolt, the empty case is withdrawn from the chamber by the extractor positioned in the bolt until it is clear of the breech; at which point the ejector, exerting a steady pressure on the base of the cartridge case, throws it to the right front by the action of its compressed spring.

The rear end of the bolt at this point forces the hammer back, rides over it and compresses the hammer spring; and finally stops in the rear end of the receiver.

As the bolt has now cleared the magazine, the maga-

zine spring forces the cartridge up until the topmost one is in line with the bolt.

The operating rod spring comes into play at this point to pull the action forward.

**Forward Movement of the Action:** As the bolt moves forward, its lower front base strikes the base of the cartridge case and pushes it into the firing chamber. The hammer, pressed by its spring, rides on the bottom of the bolt. While it tends to rise, it is caught and held by the trigger lugs engaging the hammer hook, if trigger pressure has not been released. Otherwise the trigger engages the rear hammer hook until letting go the trigger disengages the sear from the hammer. The hammer then slides into engagement with the trigger lugs.

When the bolt nears its forward position, the extractor engages near the rim of the cartridge and the base of the cartridge forces the ejector into the bolt, compressing the ejector spring.

The rear surface of the cam recess in the operating rod, now cams the operating lug down and thereby twists the bolt from left to right until the two lugs lock into their places in the receiver.

The operating rod drives ahead for another 5/16". The rear end of the straight section of the operating rod recess reaches the operating lug on the bolt, which completes the forward movement and leaves the rifle ready to fire when the trigger is pressed.

This cycle continues as long as there are any cartridges in the magazine and the trigger is squeezed.

## CARE OF THE M-1 RIFLE

The rifle must be kept clean and properly lubricated. Failure to do so may result in stoppages at a critical moment. The rifle should be inspected daily.

**To Clean the Bore:** A clean patch saturated with hot water and soap should be run through the bore a number of times. Plain water, hot or cold may be used if soap is lacking. While the bore is still wet, your metal brush should be run through several times to loosen up any material which has not been dissolved by the water. Dry patches should then be pushed through the bore until **thoroughly dry**. The bore should then be coated with light issue gun oil. Also use the chamber cleaning tool to give the chamber the same attention. Remember that powder fouling in the bore contains a salt which rusts the steel.

**To Clean Gas Cylinder: Screw on type M-1 rifle:** The carbon forming in the gas cylinder varies in amount in different weapons. When the deposit is heavy, the rifle is sluggish in action and may fail to feed. The carbon must be scraped from the exposed surface of the front of the cylinder and the gas cylinder plug and piston head after extensive firing. The mess kit knife or similar sharp bladed instrument should be used for this scraping process.

Gas cylinder plugs and grooves in the gas cylinder should be cleaned so they will feed correctly in the plug.

**Spline Type M-1 Rifle:** In this type, the lock screw

must be removed and the carbon scraped with the screw driver blade of the combination tool. The gas cylinder lock should be removed, and the lock screw inserted in the cylinder far enough to break loose any carbon. Inside the cylinder must be thoroughly wiped clean and oiled at the conclusion of any extensive firing.

**Special Note on Both Types:** When firing is expected to be resumed the next day, tilt the muzzle down and place a few drops of oil into the cylinder between the piston and the walls of the cylinder. Then operate the rod by hand a few times to distribute the oil thoroughly.

Wipe the outside of the gas cylinder and the operating rod and then oil lightly. Should no firing be expected for a week or two, remove the rod and gas cylinder lock screw (or plug) so that the cylinder is open at both ends. Then clean cylinder with rod and patches exactly as the bore of the rifle is cleaned.

Hold the weapon so that no water gets into the gas port. Do **not** remove the gas cylinder for cleaning.

Piston head and rod should be cleaned with cleaner or with water and dried thoroughly, while the rod and cylinder should be oiled before assembling. Any carbon present should be removed at this time. Do not use abrasive cloth if it is possible to avoid doing so; and should it be used, take proper care that the corners of the plug or lock screw and piston head are not rounded.



# U. S. RIFLE .30 M1.

**Attention to Other Parts of Rifles:** Graphite cup grease is issued for lubricating bolt lugs, bolt guides, bolt cocking cams, compensating spring, contact surfaces of barrel and operating rod, operating rod cams and springs, and operating rod groove in the receiver.

All other metal parts should be cleaned and covered with a uniform light coat of oil.

Wooden parts must be treated with light coat of raw linseed oil about once a month.

The leather sling should be washed, dried with a clean rag and lightly oiled with neatsfoot oil while it is still damp, whenever the sling shows signs of stiffening or drying. Rust should be removed from the metal parts with a piece of soft wood and oil, **never with abrasive**. Screw heads must be kept clean to prevent rusting.

Be careful not to use too much oil as any heavy coat will collect dirt and interfere with operations.



# U. S. ENFIELD .30 1917 RIFLE

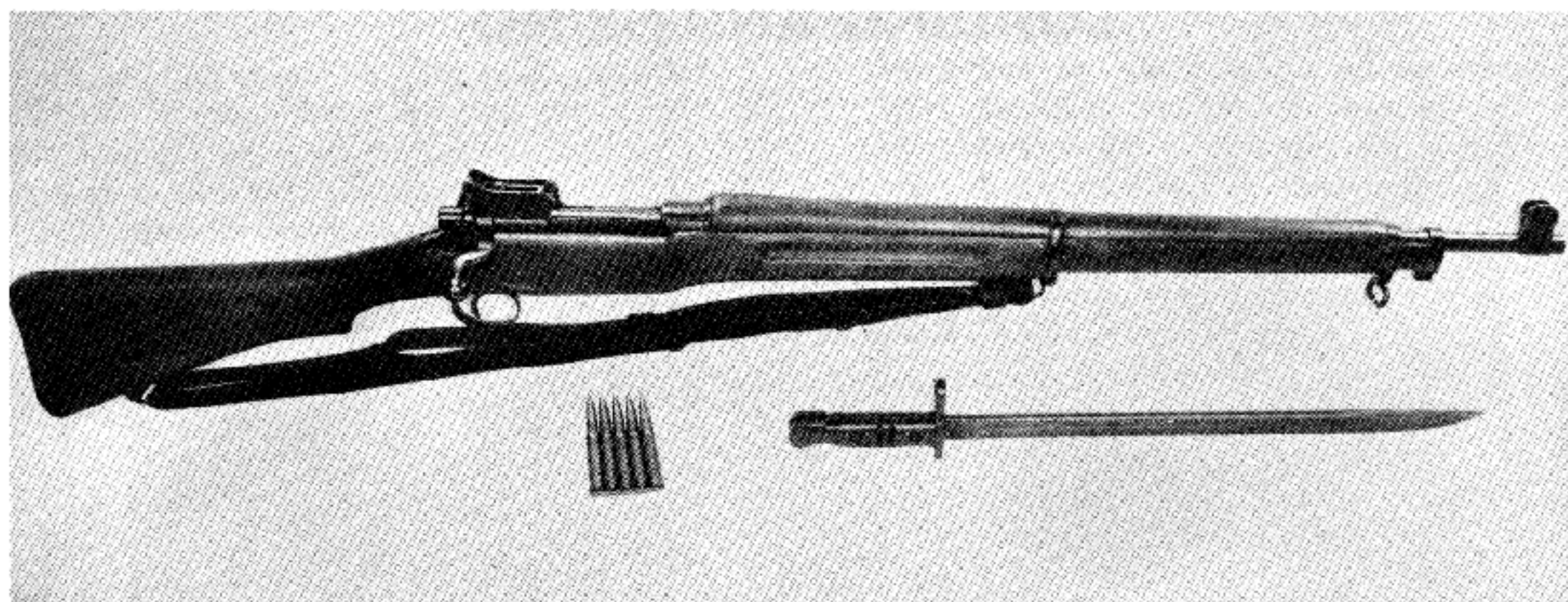

This rifle is often called the "American Enfield" in this country. During World War I, Springfield Rifles were standard equipment in our Forces; but we did not have facilities for producing them fast enough. Machinery which had been turning out British Service Rifles—popularly called "Enfield"—was converted to manufacturing a modified version of the Enfield which would take our standard rimless cartridge as used in the Springfield; and permit magazine loading with the usual service cartridge clip. Huge numbers of these very fine weapons are in use throughout the world, particularly by British units. Many are still in use in our forces, but are rapidly being replaced by Garands. In Great Britain this weapon is often erroneously called "Springfield."

**Caliber:** .30-06, M1 or M2 ammunition.

**Magazine:** Vertical box directly below the bolt. Loaded from top with a 5-cartridge clip, same as Springfield.

Cartridges rest in staggered position.

**General Ballistics:** Same as for Springfield. Note however that this weapon is not at all in a class with the Springfield for long range accurate shooting.

**Barrel Length:** 26" from base of bolt to muzzle, including chamber.

**Overall Length of Rifle:** 46.3".

**Sights:** Blade front, mounted in protective carrier. Peep rear sight mounted on receiver directly above bolt handle. Has a Peep Battle sight. When sight leaf is raised, slide may be raised vertically on the leaf and held in place by slide stop screw. The base of the slide is checked to prevent light reflection which might interfere with aiming. Numbers on leaf indicate 100-yard units, notches being at 100-yard intervals from 200 to 900 yards. Notches on right edge of sight leaf are at 100-yard intervals from 200 to

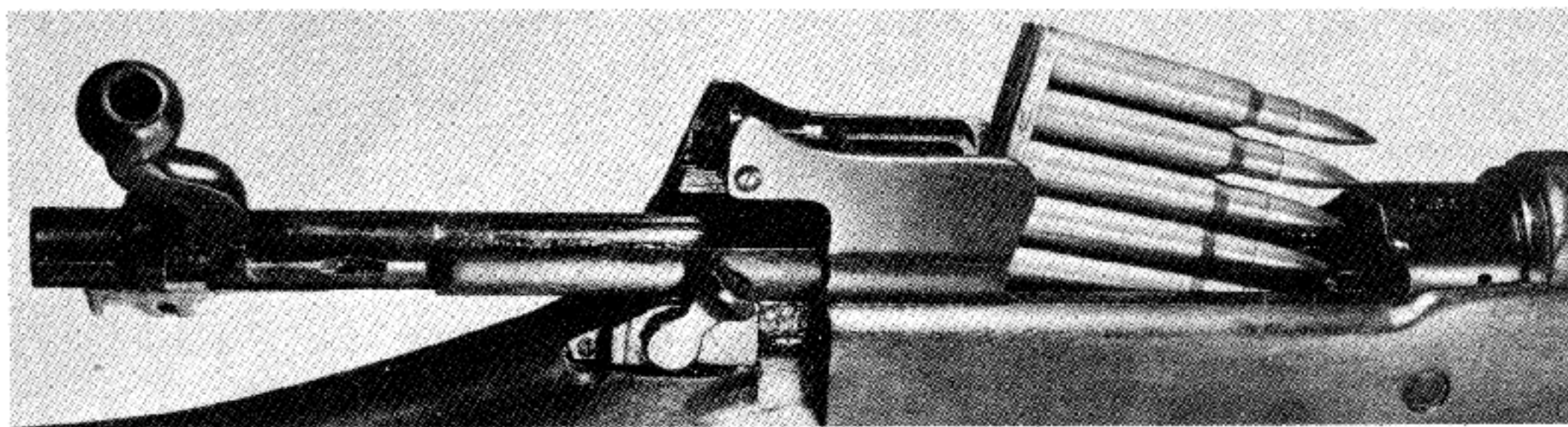

900-yards; and at 50 yard\* intervals thereafter to 1600-yard range.

**Locked:** By rotating bolt. Lugs on end of bolt as in Springfield; they lock into recesses directly ahead of the cartridge to give maximum support at the instant of firing. This is very important, as the breech pressure runs from 47,000 to 50,000 pounds per square inch in the chamber at the moment of discharge.

**Cutoff:** No magazine cutoff is provided on this rifle. It may be loaded singly directly into the chamber, but the magazine follower must be pushed down by the thumb of the left hand and the bolt started forward over the follower. This weapon is intended strictly for magazine use. When rifle is empty: magazine follower rises in path of bolt, preventing it being closed. The follower is the metal strip under which lies the magazine spring, and on top of which the cartridges rest.

**Safety:** A safety lock is provided on the right-hand side of the rifle to the rear and below the rear sight mounting. It has a heavy, swiveled thumb-piece; which when rocked back to the rear makes it impossible to fire the rifle. The forward position is the fire position. There is also a built-in safety device which prevents the trigger being pulled unless the bolt handle is down and fully locked.

**Bolt Stop:** On the left side of the receiver just below the rear sight mounting is a spring held thumb-piece; when pulled out against the spring tension, the bolt can be removed to the rear.

**Magazine Capacity:** While the capacity of the magazine is only five cartridges, as in the case of the Springfield, if the cartridges in the loaded magazine are pressed down and the bolt pushed forward over the head of the top cartridge, a sixth cartridge may then be loaded directly into the firing chamber.



# U. S. ENFIELD .30 1917 RIFLE

## LOADING AND FIRING

Raise bolt handle as far up as it will go and draw straight back to the rear as far as possible. Now place a loaded clip in the clip slots in the receiver (clip may be inserted by either end), and with thumb of right hand push cartridges down into magazine until the top cartridge is caught and held by the right edge of the

receiver. Clip may be pulled out, or the forward motion of the bolt will knock it out of the rifle as the bolt is pushed forward to load the topmost chain cartridge into the firing chamber. The rifle is now ready to fire; it cocks as the bolt is thrust forward.

## FIELD STRIPPING

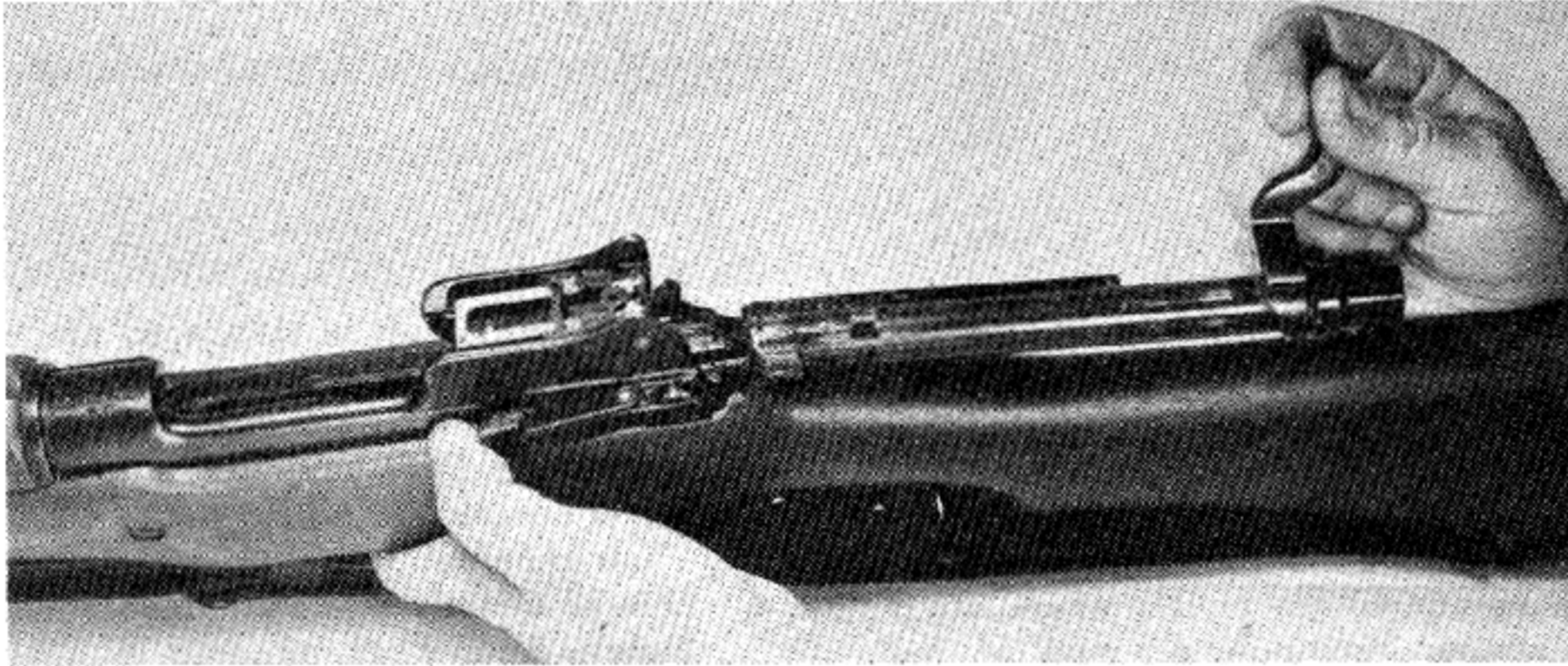

Pull out thumb-piece at forward end of the bolt stop against tension of the spring. While holding this out, pull the bolt straight out to the rear.

**To dismount bolt:** Hook a loop of string over dismounting hook on cocking piece lug; hold bolt firmly in left hand and draw cocking piece out until lug clears end of bolt.

Turn with right hand from right to left to unscrew sleeve from bolt; this permits withdrawal of sleeve, cocking piece, and striker.

Hold sleeve with left hand and rest point of striker against a wooden surface (this is necessary so striker point will not be injured). Force sleeve towards the point of striker, thus compressing the mainspring until the cocking piece lug clears the lug slot in the sleeve. With right hand, twist cocking piece a quarter turn right or left which will disengage it from the striker and permit it to be drawn off to the rear.

Relieve spring tension slowly as it is removed, being careful that parts do not fly from the hand. Now turn extractor to cover the gas escape holes in the bolt, and push it forward with thumb until it is free of the ears on the collar.

**To Assemble Bolt:** With mainspring sleeve over the striker, press point of striker against wooden surface and placing the sleeve against the end of the spring (see that the flats in its bore register with the flats on the striker), compress spring by forcing sleeve toward the point of the striker.

## HOW THE U. S. RIFLE MODEL 1917 WORKS

Starting with the rifle just fired: The bolt handle is raised which turns the bolt to the left. The lug at the rear of the bolt rests against the cocking piece groove and is prevented from turning and so is forced to the rear in the bolt by the half cocking cam; and it engages the half cocked notch, withdrawing the striker into the

When the bolt has been turned up far enough for its

Hold sleeve with spring fully compressed and put cocking piece back on end of striker, locking it by a quarter turn so its lug will line up with the lug slot in the sleeve.

Now let the sleeve return to its position slowly under action of the spring.

Holding bolt firmly in left hand start the threads on the barrel of the sleeve into the threads at the end of the bolt.

With right hand hold string looped around dismounting hook on cocking piece, draw cocking piece out. Again moving right hand in a circular path, this time from left to right, screw the sleeve home into the bolt. Place the lug in the half cocked notch.

Now slide the extractor in place in line with the gas escape holes, being sure the undercut lug on the extractor engages with the gears on the ring. Lift the hook so its tongue will slide over end of bolt. Turn the extractor so it lies over the solid lug and replace bolt in the receiver. Push down magazine follower, force bolt home and turn it down into its locking place.

**Stripping Magazine Mechanism:** The same as the Springfield rifle. Press bullet end of cartridge through hole in floor plate at bottom of magazine, and at same time draw floor plate to the rear. This will release the floor plate which will come out carrying the magazine follower. The rifle should be held upside down when this is done.

**To Assemble:** Reverse the foregoing procedure.

locking lugs to be turned out of their locking recesses, the locking cams and safety lug on bolt handle clears the receiver safety lug; the extracting cams on the bolt and receiver engage and act together during the continued rotation of the bolt to draw back the bolt a short distance and start the extraction of the empty case from the chamber. During this period of bolt rotation, the guide in the receiver prevents the extractor from turn-



# U. S. ENFIELD .30 1917 RIFLE

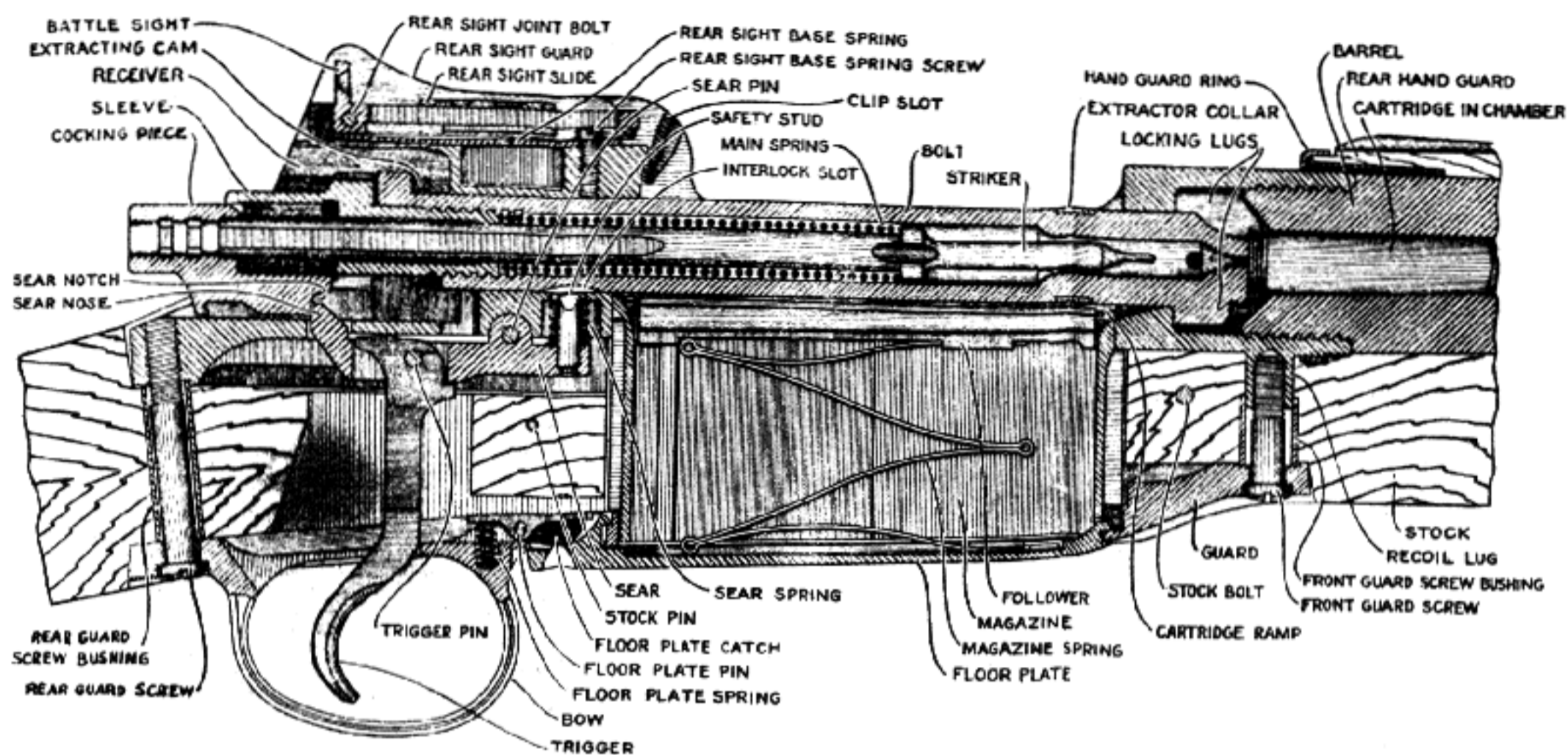

ing; while the sleeve is held against rotation by engaging with the receiver. When the bolt has gone up as far as it will, the locking lugs are in a horizontal position. The bolt may now be drawn back straight to the rear, with the extractor pulling out the empty case.

During the first stage of backward travel of the bolt, the cocking piece passes over and depresses the nose of the sear; and the safety stud rises into the clearance provided for it on the bolt. As the cocking piece clears the nose of the sear, the sear is raised to normal position by its spring.

As the rear face of the slotted locking lug reaches the ejector, the ejector is forced into its slot in the lug and protrudes through it. As the rearward movement continues, the empty case strikes against the ejector and is hurled out to the right.

The bolt passes over the rear end of the top cartridge in the magazine just before the empty is ejected. Then the backward movement is halted by the slotted locking lug striking against the bolt stop lug. This completes the rearward motion.

**Forward Motion of the Bolt:** If magazine is empty, the spring forces the follower up in line with the bolt so the bolt cannot be pushed forward. This notifies you the magazine is empty. If there is a cartridge in the magazine, the forward stroke of the bolt drives it forward and the extractor head snaps over the groove in the cartridge case.

During the first stage of the closing movement, the ejector is thrust outward by the side of the bolt, then

the sear notch in the cocking-piece connects with the sear nose and is held; the bolt then slides forward over the striker to further compress the mainspring.

As the bolt handle is turned down into locking position, its locking lugs engage the locking cams, forcing the bolt home; seating the cartridge in the chamber; and completing compression of the mainspring. This bolt rotation also restores the half cocking cam, turning it out of the path of fall of the cocking piece lug.

The bolt handle is now fully down, the bolt is locked, the mainspring fully compressed and the cocking-piece held back by the sear nose. As the trigger is squeezed, the bearing of the trigger acts on the bearing of the receiver, slowly depressing sear nose and providing the first (or slack) trigger pull.

Next the heel of the trigger engages the receiver completing the depression of the sear nose and forwarding the creep movement which terminates in the release of the cocking piece by the sear nose. This permits the striker to be driven forward by the mainspring, to strike the primer of the cartridge and fire the charge. As the sear nose is being depressed, the safety stud rises through its hole in the bottom of the well to enter the interlock slot in the bolt. Hence if the bolt is not fully locked, the inter lock slot does not register with the safety stud and the trigger is prevented from being pulled.

As pressure on the trigger is relaxed, the sear spring returns the sear and the trigger to their normal position.

## NOTE ON OPERATION OF BOLT ACTION RIFLES

The foregoing description of the functioning essentially covers all bolt action rifles of the Mauser type. While various models throughout the world differ in details, the general magazine and locking principles are much the same. A knowledge of the rifle just described enables you to grasp very easily the operating detail of most of the bolt action rifles in use.

**The British Enfield System** differs in that the locking lugs are at the rear of the bolt. This does not give enough bolt support to permit the superlative accuracy of the Springfield. On the other hand, the British system

permits easier cleaning of the locking recesses; and faster action under all conditions. Aimed rate of fire with the British type is about one-third faster than with the Mauser type. On the other hand, for sniper rifles the British generally use the "Pattern '14" which is the same as our Enfield except that it uses the British .303 cartridge.

**Mannlicher and Straight Pull Systems:** Both of these systems are inferior to the Mauser and the British systems. They will be explained in connection with rifles which employ them.



# U. S. REISING .45 50 AND 55 SUBMACHINE GUN



**MODEL 50**

**Caliber:** .45, M1911 cartridge, ball or tracer ammunition.

**Magazines:** Box type, holding 12 cartridges in single line box or 20 cartridges in double line box. Magazine positioned under receiver.

**Muzzle Velocity of Cartridge:** About 920 feet per second with this barrel length.

**Weight of Bullet:** 234 grains, lead with metal jacket.

**Muzzle Striking Energy of Bullet:** 431 foot pounds.

**Barrel Length:** 11 inches.

**Overall Length of Gun:** 35 $\frac{3}{4}$  inches (including compensator).

**Weight, without Magazine:** 6 $\frac{3}{4}$  lbs.

**Weight of Loaded 12-Round Magazine:** .94 lbs.

**Weight of Loaded 20-Round Magazine:** 1.4 lbs.

**Front Sight:** Partridge type, can be adjusted to right or left.

**Rear Sight:** Aperture. By raising rear sight and sliding sight elevator, it can be adjusted for 50, 100, 200 and 300 yard ranges.

**Accurate Range:** About 300 yards shooting against men.

**Gun Operated By:** Rearward pressure of gas in firing chamber pressing back on fired cartridge case and supporting bolt

**Locked:** By retarded blowback during period of high pressure. Friction of cammed surfaces on bolt and receiver and resistance of action bar spring keep the weapon locked until bullet has left the barrel.

**Cooled:** By cooling fins which radiate heat from barrel during firing.

**Cyclic Rate of Fire:** 450 to 600 shots per minute.

**Position of Action Bar (which is pulled back to cock Gun):** In slot cut in bottom of stock in front of magazine.

**Type of Fire:** By pressing down and setting selector (on right side of gun just below the rear sight elevator) gun may be set for either semi-automatic fire (S.A.), one shot being fired for each pull of the trigger; or for full automatic (F.A.), the gun firing as long as the trigger is held and there are any cartridges in magazine. Selector may also be used to make gun safe by setting on (S).

**Compensator:** This is a metal tube fastened on the end of the gun barrel. It is solid on the bottom. The top is cut back somewhat, and has slots cut in it. When the bullet leaves the barrel, the powder gases expand in the compensator. By deflecting these gases the compensator assists the gunner in controlling upward climb of the muzzle in full automatic fire.



**MODEL 55**

**Barrel Length:** 10 $\frac{1}{2}$  inches.

**Overall Length of Gun:** 22 $\frac{1}{2}$  inches (without compensator and with steel folding stock folded forward).

**Weight, without Magazine:** 6 $\frac{1}{4}$  lbs.

**Note:** All other data same as for Model 50. This gun

was developed at the request of Marine Corps experts for use with either one or two hands. Extensively used by Parachute Troopers, Mechanized Troops and Vehicle Operators.



# U. S. REISING .45 50 AND 55 SUBMACHINE GUN

## INSTRUCTIONS FOR LOADING AND FIRING



1. To Withdraw Magazine: Press Magazine Release Catch with right forefinger and withdraw Magazine with left hand.

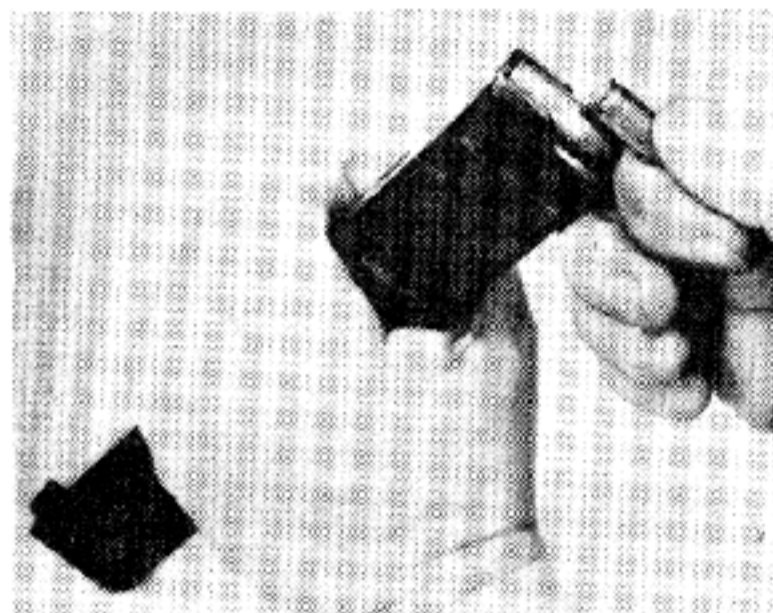

2. To Load Magazine: Hold in left hand. Rest on a solid surface or hold base against hip. Press Cartridge down on front end of Magazine Follower. Slide in under curved lips of Magazine. Repeat until Magazine is filled.



3. To Insert Magazine: Push up into Magazine Guide until Magazine Catch locks Magazine.

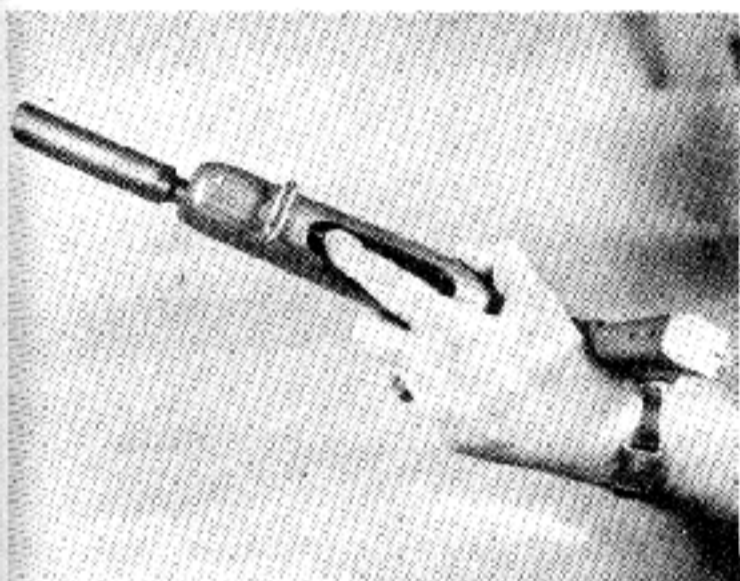

4. To Cock Gun and Load Firing Chamber: With forefinger of left hand, pull back Fingerpiece of the Action Bar as far as it will go. This will (a) Compress the Action Bar Spring. (b) Push back the Bolt. (c) Cock the firing mechanism. (d) Permit Magazine Spring to push top Cartridge in Magazine up into line with the Feed Rib on bottom of Bolt.

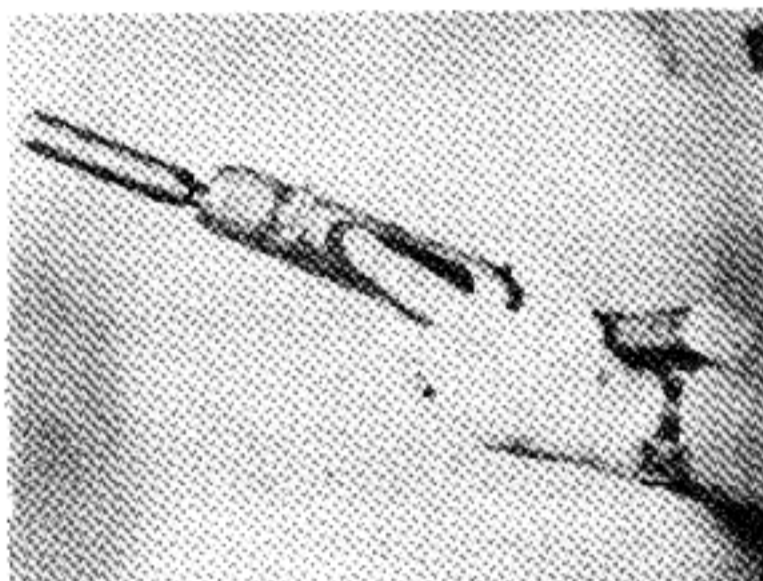

5. Now remove forefinger from Action Bar Fingerpiece and permit Action Bar to snap forward. The compressed spring will (a) Drive the Bolt forward. (b) The Bolt will push the first Cartridge into the Firing Chamber. (c) Extractor set in face of Bolt will spring over head of Cartridge and lock in groove ready to extract empty case. (d) Bolt will lock and Firing Mechanism engage so that a pressure on the Trigger will fire the Gun.

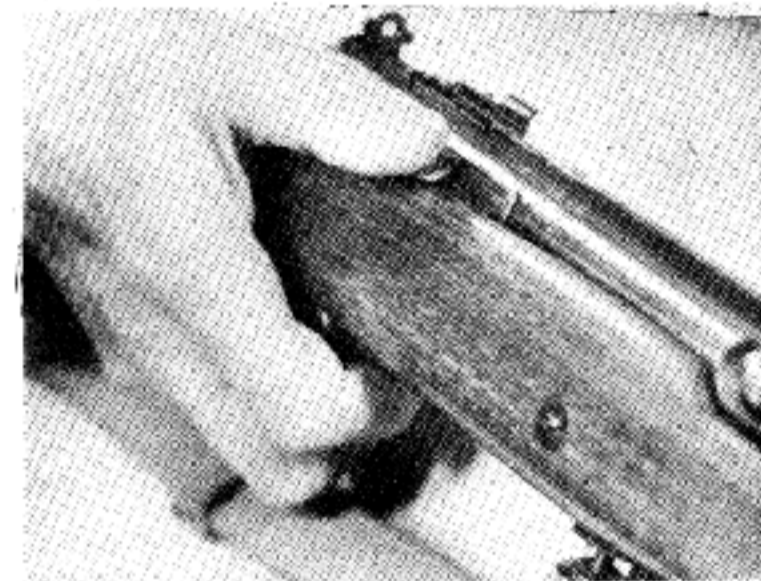

6. To Set Selector: (a) If weapon is not to be used at once, set Selector on "S" (Safe). It cannot be fired in this position. (b) For all normal use, set on "S.A." (Semi-Automatic). It will now fire, eject and reload, one shot for each press of the Trigger. (c) For emergency fire under unusually dangerous conditions, set on "F.A." (Full Automatic). Gun will fire as long as Trigger is held and Magazine contains any Cartridges.



7. Official Marine Photograph: Correct grip for firing Model 50.



8. Official Marine Photograph: Correct grip for firing Model 55, whether kneeling, sitting, standing or prone.



# U. S. REISING .45 50 AND 55 SUBMACHINE GUN

## FIELD STRIPPING

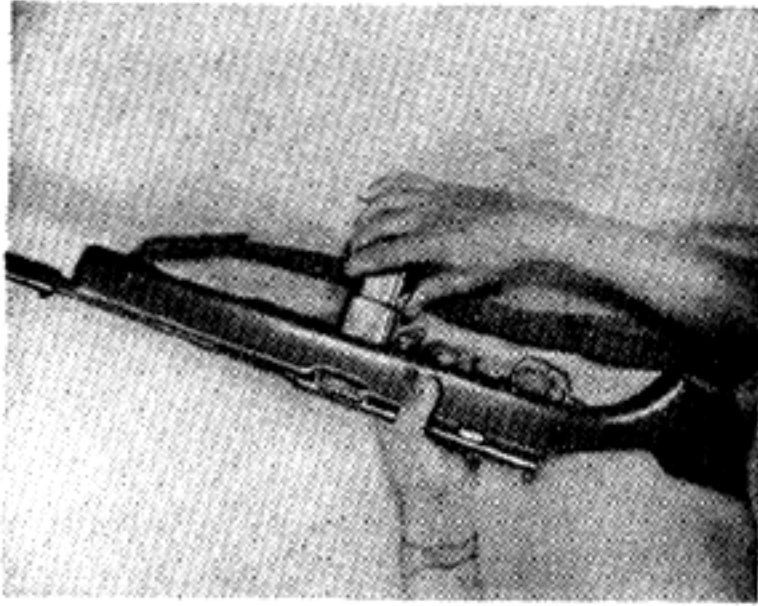

1. (a) Set Selector on "F.A." (b) Press magazine release forward and withdraw magazine.

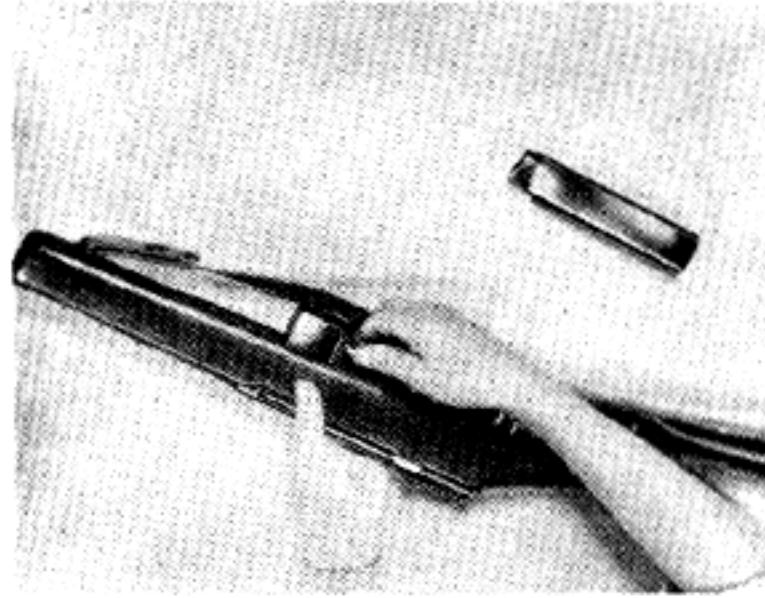

2. Unscrew Take-Down Screw, which is just to rear of Magazine Guide.

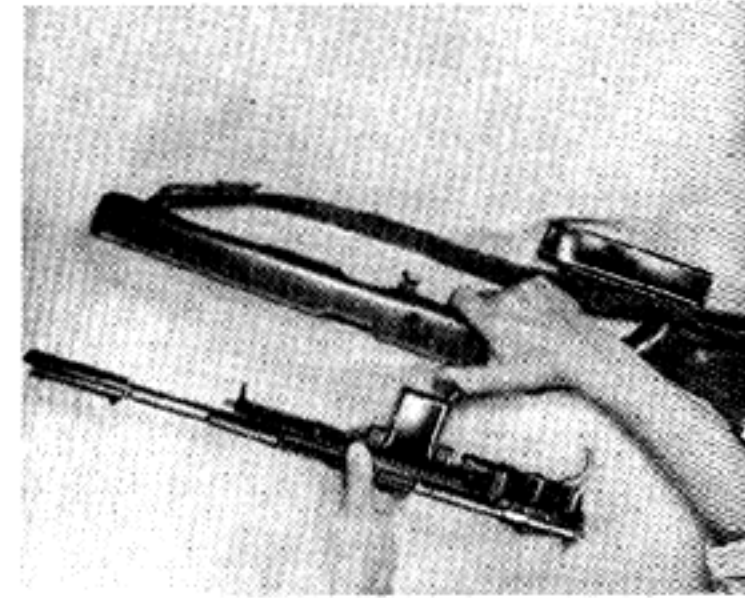

3. Remove Stock as shown.

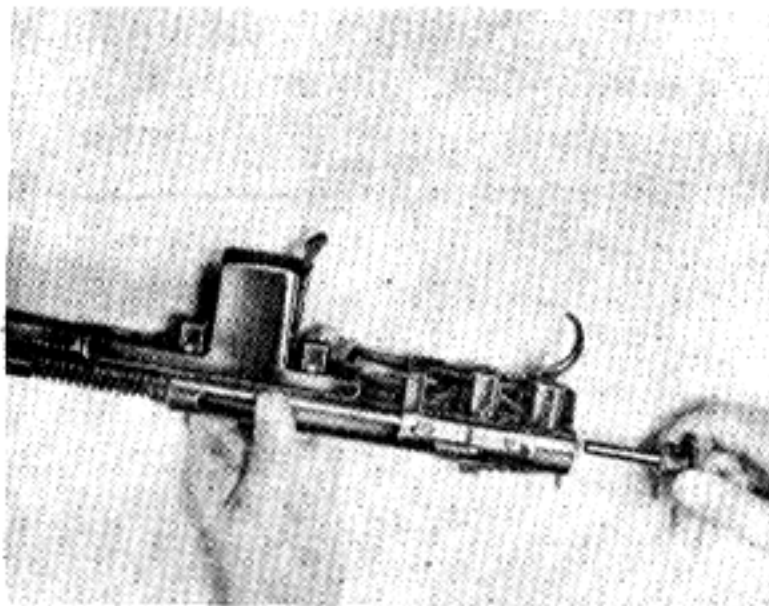

4. (a) Pull Trigger to release tension of Hammer Spring. (b) Unscrew Bumper Plug.

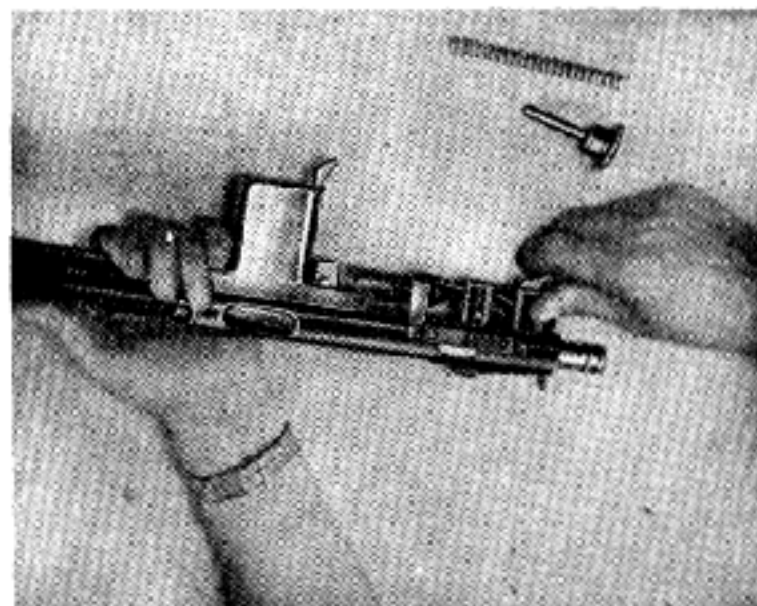

5. Withdraw Hammer Spring. Pull Trigger and let Hammer Slide out.

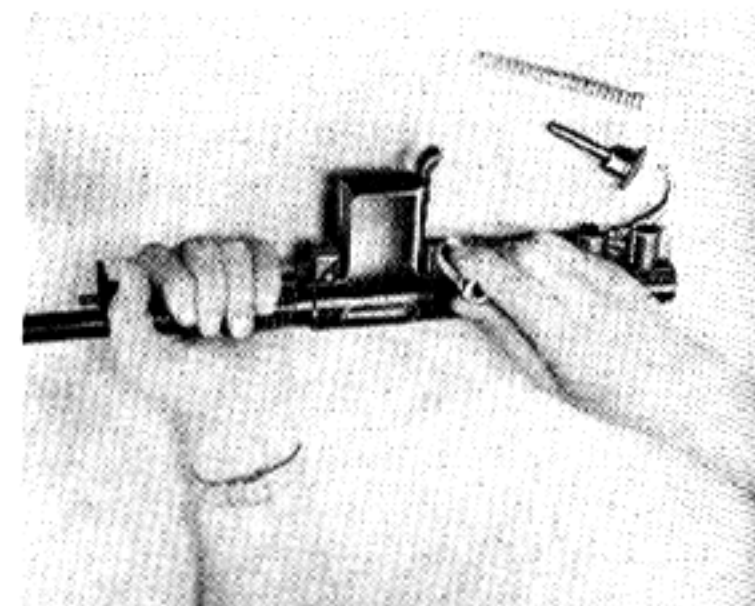

6. (a) Push out the tapered magazine Guide Pins. If they are tight, drive them out with the Gun Hammer as shown above. (b) Remove Magazine Guide.

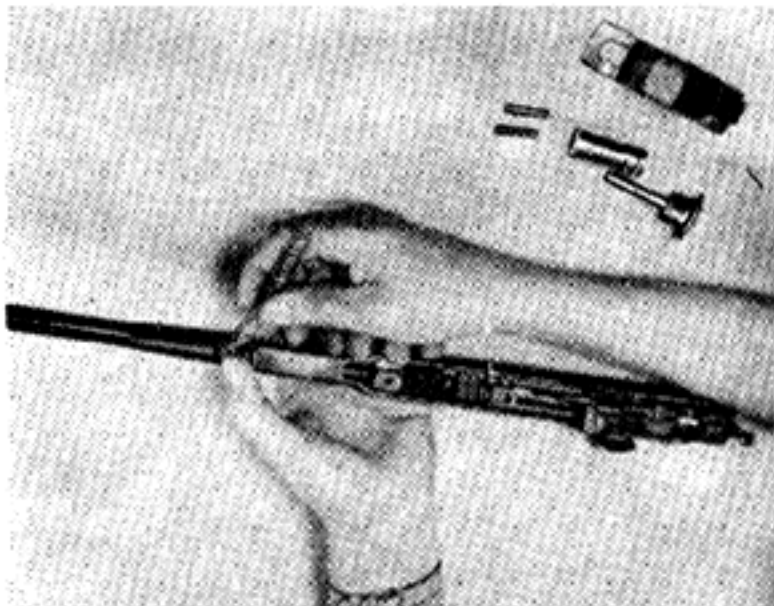

7. With left thumb, push Action Bar to rear until the dismounting hole in the Action Bar Spring Guide can be seen. Then insert end of Hammer Spring in the dismounting hole.

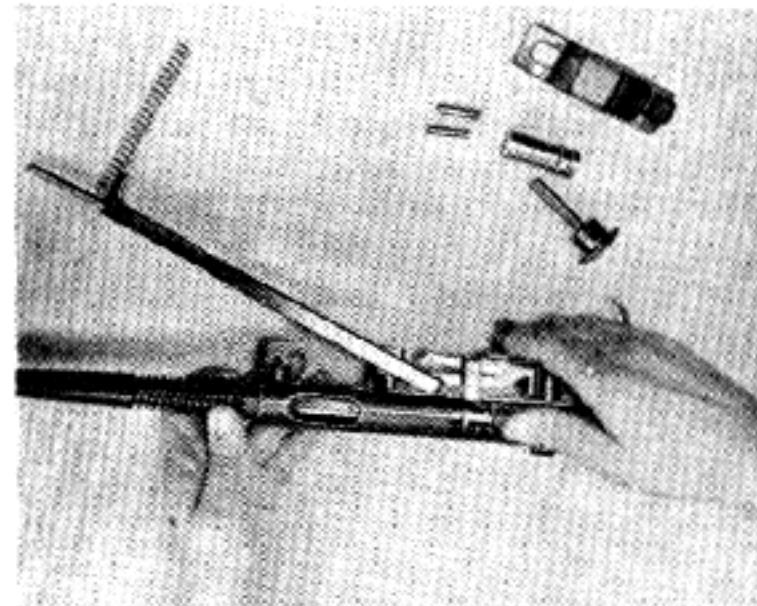

8. With forefinger of right hand, hold up ends of Connector and Disconnecter. With left hand lift forward end of Action Bar to 90 degree angle.

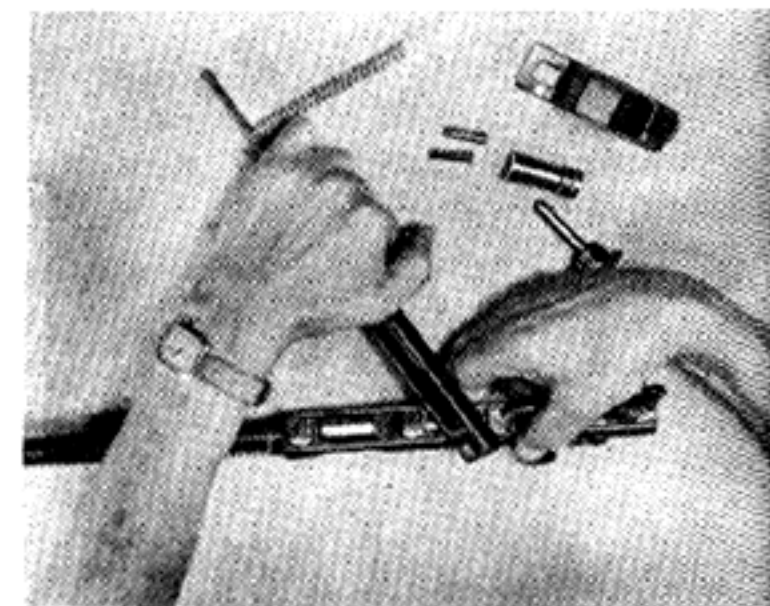

9. Twist out Action Bar as shown. Be careful not to put strain on Connector and Disconnecter.

**Note:** This weapon is so simple and rugged that it will seldom if ever require more detailed stripping.

Any further disassembly should be done only by qualified armorer.

Parts should be oiled very lightly, as heavy oiling will tend to slow down the functioning.



10. Point muzzle up. Pull Trigger. Bolt will now drop out. This completes Field Stripping.



# U. S. REISING .45 50 AND 55 SUBMACHINE GUN

## FIELD ASSEMBLY OF GUN

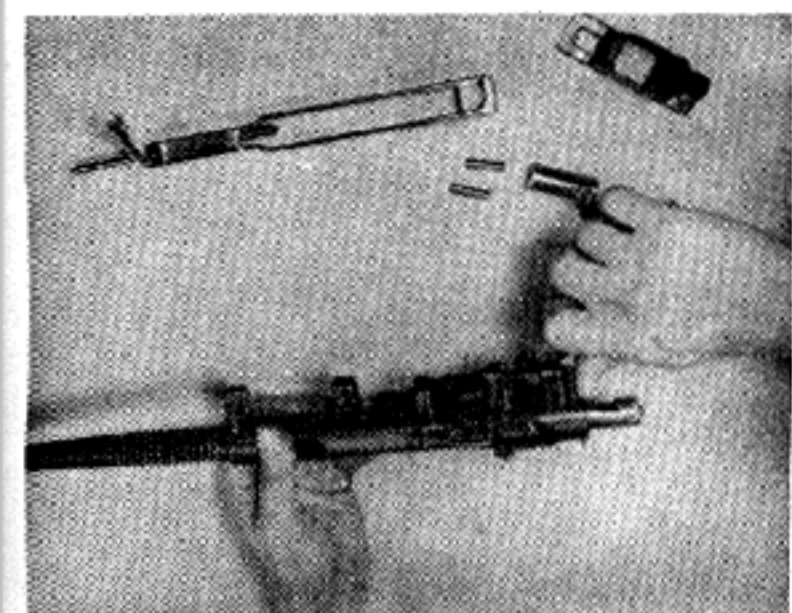

1. Depress Trigger. Place Bolt in Receiver and slide it forward.

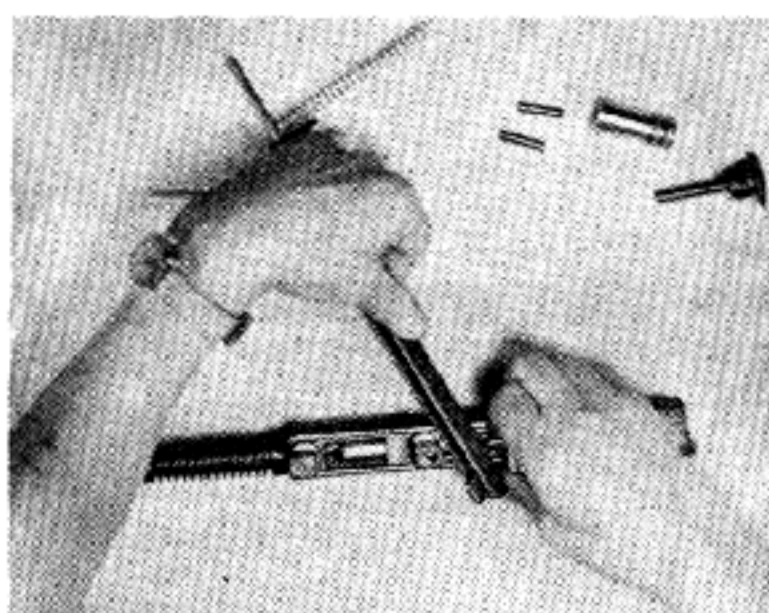

2. Lift ends of Connector and Disconnector and twist Action Bar in under ends of Connector and Disconnector.

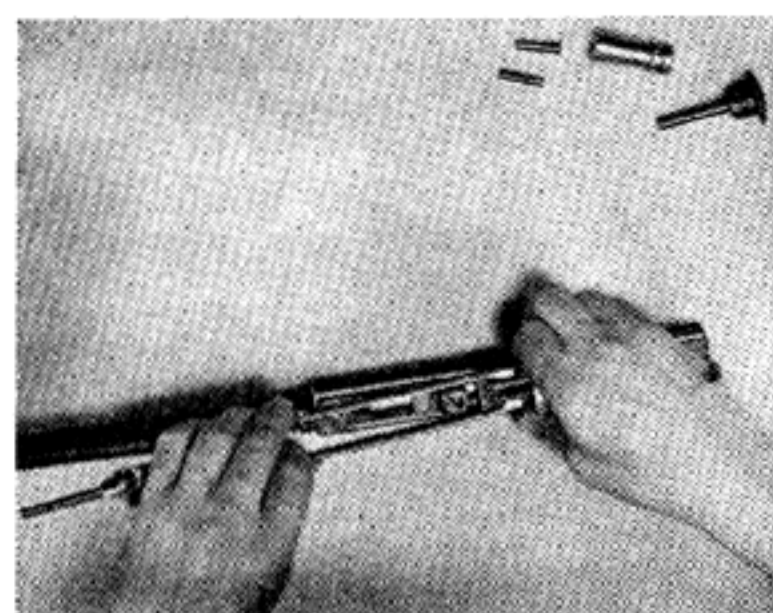

3. Lay the Action Bar in place with Action Bar Camming Lug in the Bolt Camming Recess as shown.

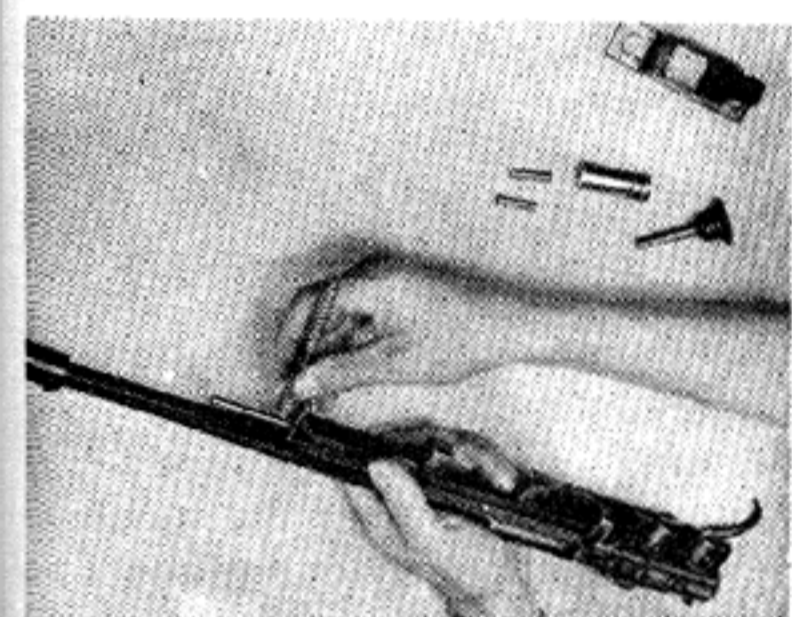

4. Insert Action Bar Spring Guide in seat in post and remove the Hammer Spring from the dismounting hole.

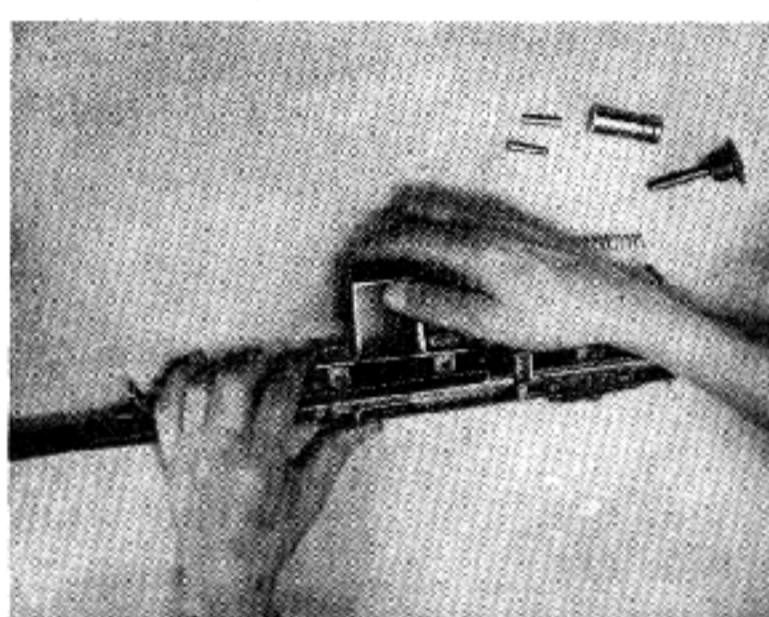

5. Replace the Magazine Guide.

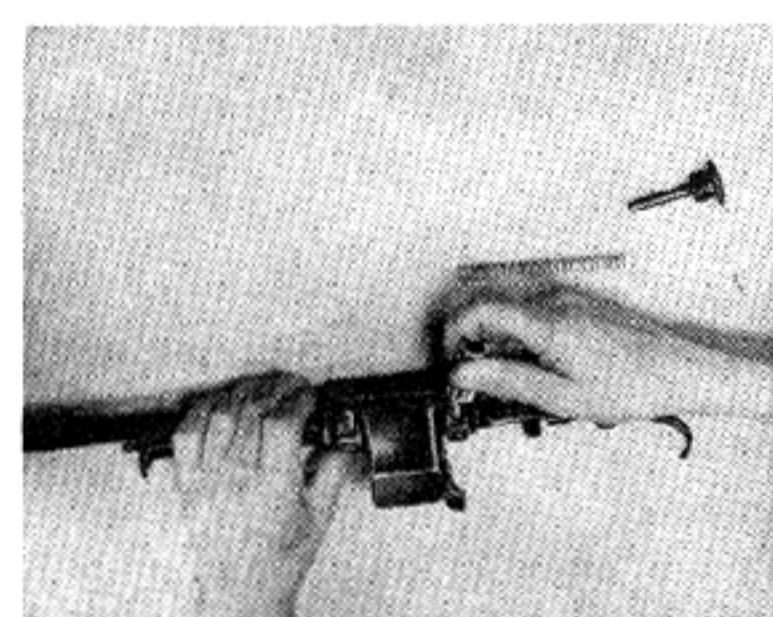

6. Insert the Tapered Pins.

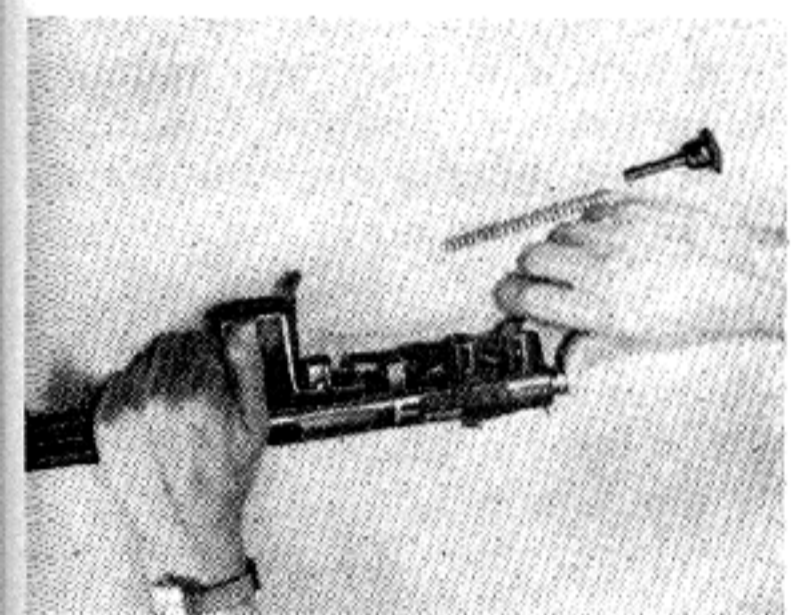

7. Insert the Hammer, small hole forward. Pull Trigger and Hammer will fall on the Bolt.

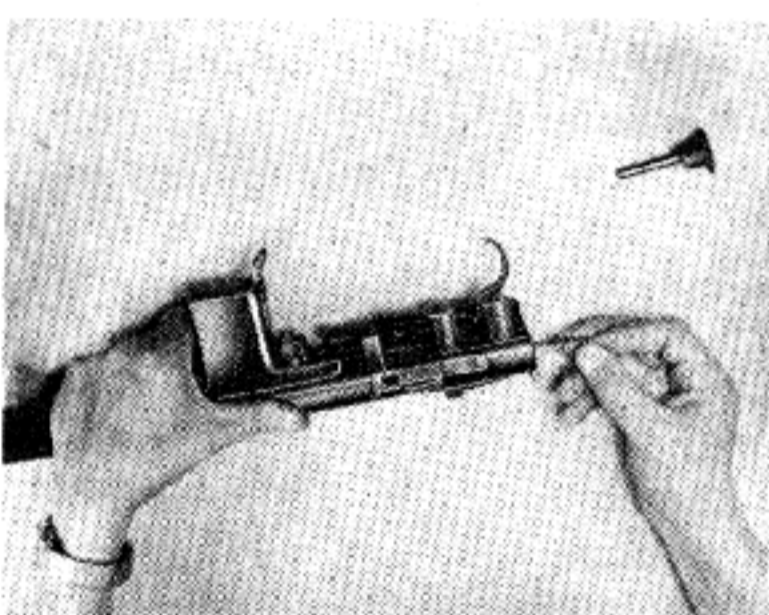

8. Replace Hammer Spring in the receiver.

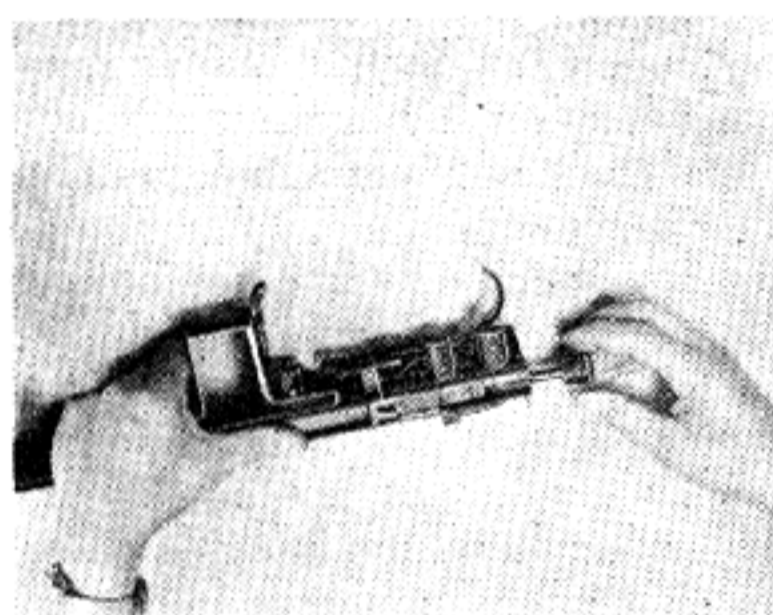

9. Screw the Bumper Plug into place.

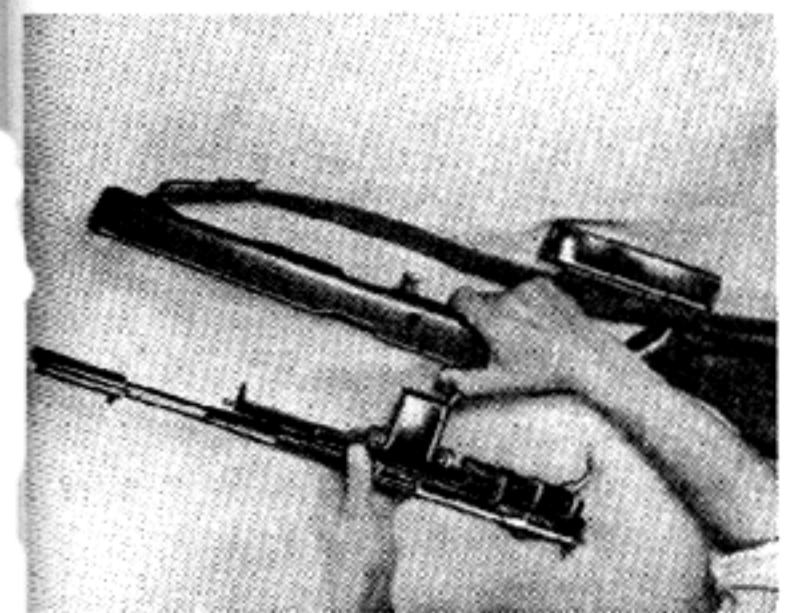

10. Replace Stock and tighten Takedown Screw.



# U. S. REISING .45 50 AND 55 SUBMACHINE GUN

## HOW THE REISING GUN WORKS

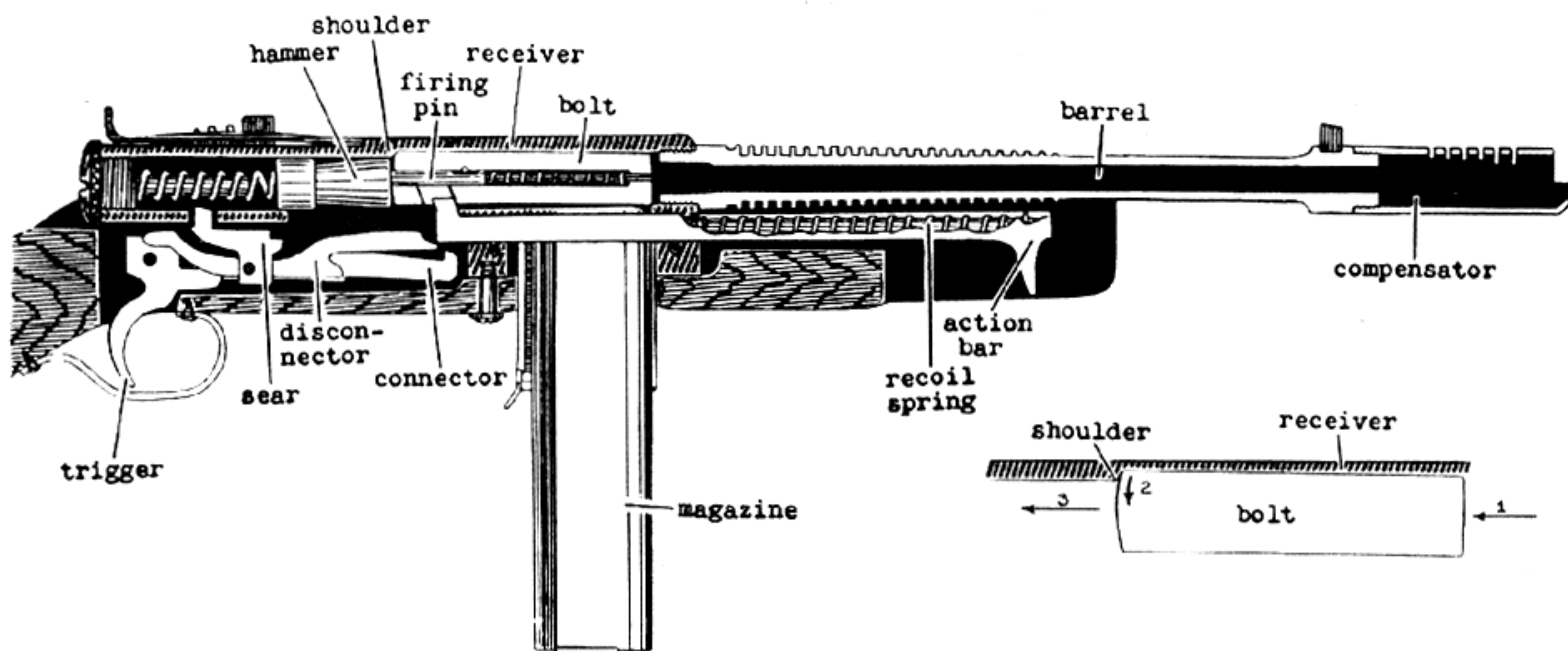

**Starting with the Gun Loaded and Cocked the action is as follows:** The Trigger is pressed. This results in the hammer being released to be driven forward by the compressed hammer spring. The hammer drives the firing pin against the primer in the head of the cartridge. The primer explodes the powder in the shell.

The bullet is driven forward and out of the barrel.

The rearward thrust of the gases formed by the combustion of the powder pushes the empty cartridge case (or shell) back against the bolt. The heavy action bar spring, together with friction of cammed surfaces of the bolt and receiver, keeps the action closed until the bullet has left the barrel, and the pressure has dropped to safe limits.

The blow-back of the gases now drives the bolt and action bar to the rear in a straight line, compressing the action bar spring. As the bolt moves to the rear, the extractor set in the bolt face and hooked over the now empty shell pulls the shell out of the firing chamber. The pressure still in the barrel is called residual pressure. It works with the extractor by pushing the empty shell back into the receiver. This shell now strikes against the ejector and is cammed up and out of the gun through the ejection port on the right side of the gun.

As the bolt passes to the rear over the top of the

magazine, the magazine spring forces a cartridge up into line.

The backward movement of the action cocks the hammer spring, which is compressed over the guide of the bumper plug. The rearward motion of the recoiling parts is stopped by the bolt and hammer striking against the bumper plug.

**Return Movement of the Action:** The energy stored up by the compression of the action bar spring now drives the action forward. The feed rib on the bottom of the bolt strips the top cartridge from the magazine.

The bolt as it nears its foremost position is cammed up into the locking shoulders of the receiver by the camming lug on the action bar working in the camming recess in the bolt.

As the bolt drives the cartridge into the firing chamber, the extractor snaps over the head of the cartridge.

When the bolt locks, the firing pin is moved into position to be engaged by the hammer.

The trigger mechanism engages. The piece is now ready for the next shot.

If the selector is set for "S.A.," pressing the trigger is necessary to fire. If the selector is set on "F.A.," the trigger mechanism permits the hammer to go forward if the trigger is held back.

## STOPPAGES AND "IMMEDIATE ACTION"

This weapon is so simple and rugged in construction that very few stoppages are likely to be encountered if the weapon is given reasonable care and cleaning.

If the weapon has been kept clean and lightly oiled (too much oil slows down the mechanism), stoppages are likely to be caused by either faulty ammunition or defective magazines.

If the magazine spring has been weakened or the lips of the magazine damaged, the weapon may fail to feed.

If the ammunition is defective, it may fail to fire after being chambered or may stick in the action.

**Immediate Action:** This is the action taken automatically as the probable remedy. (1) Retract action bar

with a quick motion to eject the cartridge in the chamber. (2) Resume fire.

**If the Gun Still Fails to Fire:** (1) Set selector on "Safe." (2) Remove magazine. (3) Pull back action bar and look through ejection port to see if gun is cleared. (4) Insert new magazine. (5) Reset selector and resume firing.

**Note:** When applying "Immediate Action" always keep gun trained on the target. Put your finger on the trigger only while the gun is pointing at the target. Use "F.A." only in case of emergency. Then fire in bursts of 3 to 5 shots. One body hit with a .45 bullet will stop almost any enemy.



# U. S. REISING .45 50 AND 55 SUBMACHINE GUN

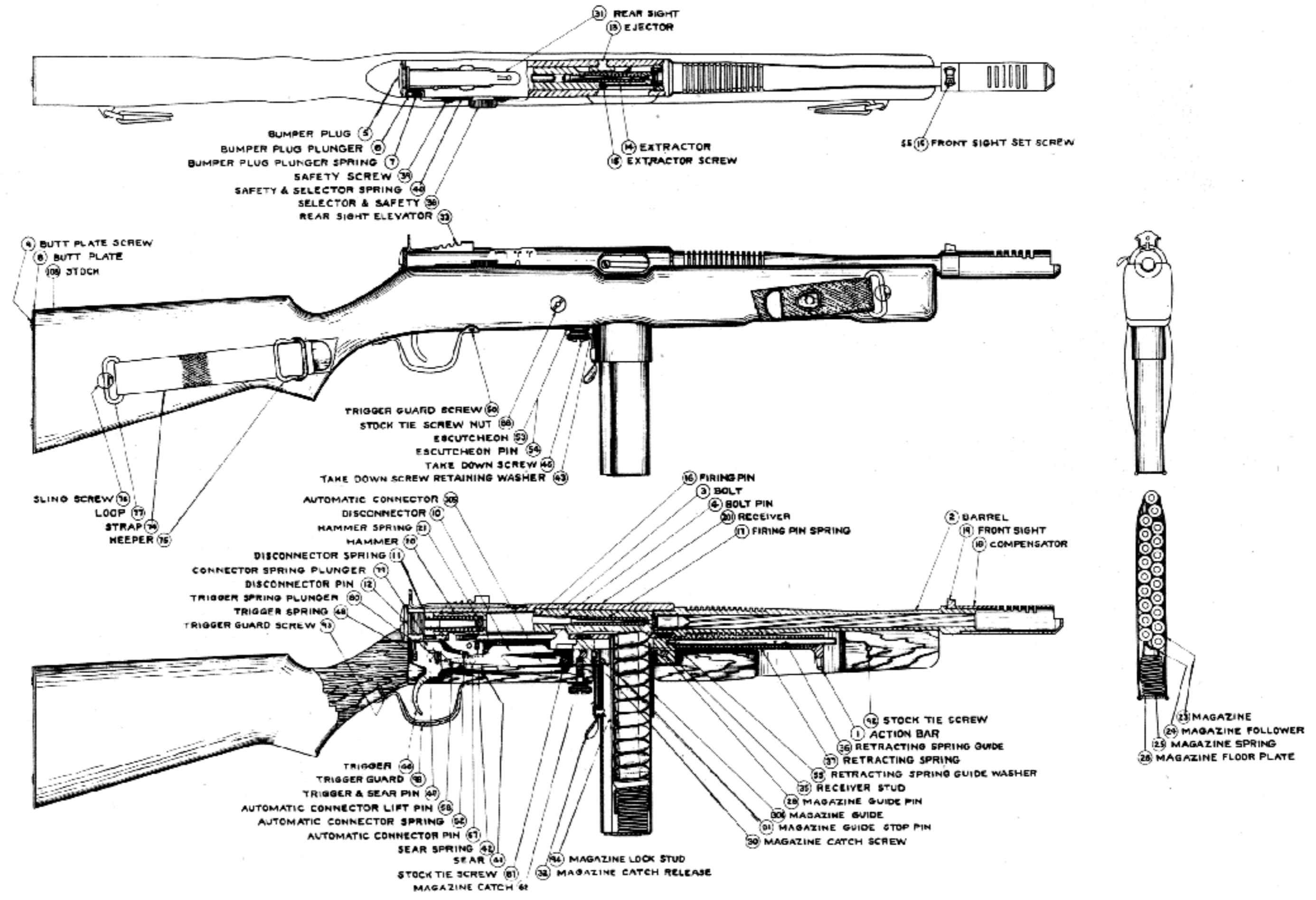



# U. S. THOMPSON .45 1928 SUBMACHINE GUN

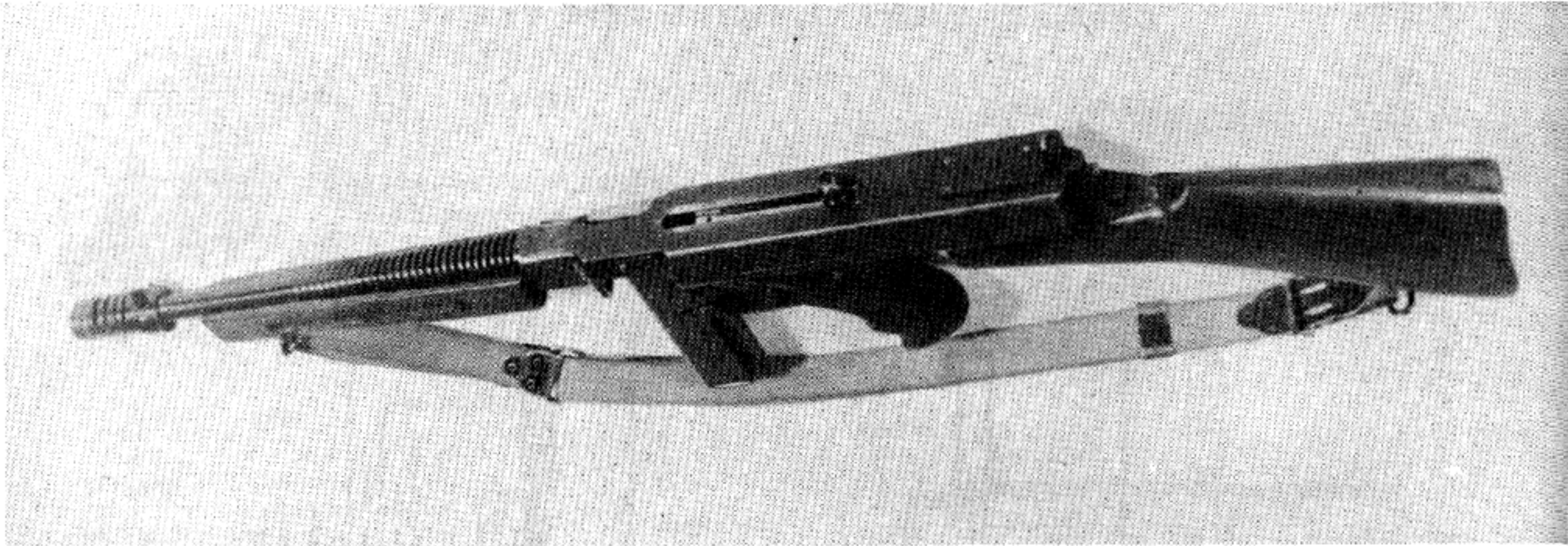

This is doubtless the most widely known of all the sub-machine weapons. It is in wide use throughout the world, over 2,000,000 having been manufactured. It will probably eventually be supplanted in our own Armed Forces, by the M-3 submachine gun recently developed by our Ordnance Department, which is simpler, sturdier, and infinitely cheaper to manufacture.

**Caliber:** 45 M 1911 cartridge, ball and tracer ammunition.

**Magazines:** (a) Types XX staggered box 20 shot capacity. (b) Type L. Drum, 50 rounds capacity. (c) Drum 100 round capacity, now obsolete.

**Muzzle Velocity Cartridge:** With this barrel about 950 feet per second.

**Muzzle Striking Energy:** About 440 foot pounds.

**Barrel Length:** 10 $\frac{1}{2}$ " (With compensator on muzzle, 2" longer).

**Overall Length of Gun:** With stock and compensator about 33".

**Overall Length Without Stock:** 25 $\frac{1}{4}$ ".

**Weight Without Magazine:** 9 lbs. 13 ozs.

**Weight of Loaded 20 Round Magazine:** About 1 $\frac{1}{4}$  lbs.

**Weight of Loaded 50 Round Magazine:** About 4 $\frac{3}{4}$  lbs.

**Front Sight:** Fixed blade.

**Rear Sight:** Aperture, graduated to 600 yards with lateral adjustment to allow for windage and drift. A 50-yard open sight is provided for close quarters work with sight lever down. (Note: Gun may also be fitted with operative battle sight without adjustment.)

**Accurate Range:** About 300 yards.

**Operated by:** Rearward pressure of gas in firing chamber pressing back on fired cartridge case and its supporting bolt. This is a standard recoil system.

**Locked:** Claimed Semi-locked by adhesion. Delayed locking system is claimed for this weapon. However, the weapon functions equally well with or without the alleged locking device. (Note: Later and cheaper models of this gun eliminate the so-called "Blish Principle" of adhesion of slipping inclined faces.)

**Cooled:** Cooling fins on barrel. Bolt stays open between shots, permitting circulation of air through breech opening and barrel.

**Cyclic Rate of Fire:** 600 to 700 per minute. (In some commercial models it is much higher.)

**Actuator Knob:** This is commonly known as a cocking handle. It is mounted on top of the receiver in the line of sight; and is slotted down the center to permit proper sight alignment.

**Type of Fire:** Single shot or full automatic. When weapon is cocked, the fire control lever positioned on the left side above the pistol grip may be pushed to either "Single" or "Auto." Also on the left side above the pistol grip is the thumb safety. It can be pushed to positions stamped "Safe" or "Fire." Note that the gun **must be cocked** before either of these levers can be set.

## INSTRUCTIONS FOR LOADING AND FIRING

**To load box magazine:** Load as for automatic pistol magazine, but support base of magazine against body or a solid surface if heavy spring tension makes it difficult to force cartridges down.

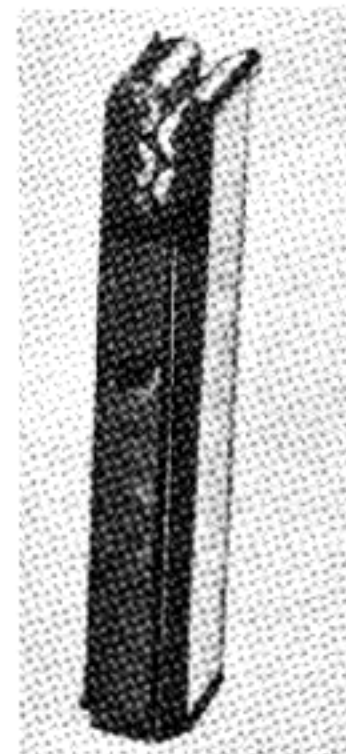



# U. S. THOMPSON .45 1928 SUBMACHINE GUN



**To load drum magazine:** Raise the flat magazine key spring to disengage its stud

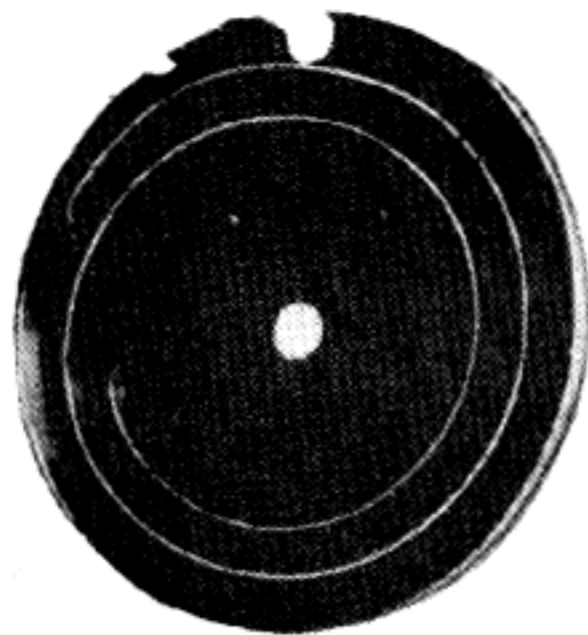

and slide the key off via its slot. Lift off the magazine cover. Insert 5-cartridges

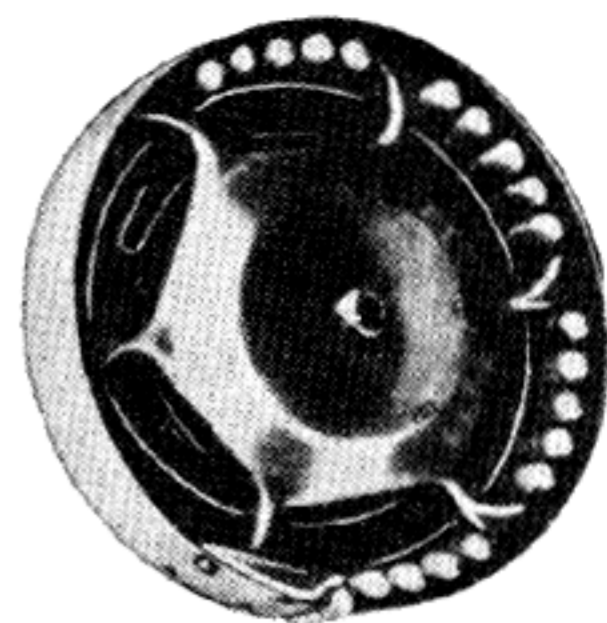

base down in that section of the rotor in which the magazine feed opening is cut. Loading from right to left, place 5-cartridges in each section of the spiral track, taking care to load all **Outer Spirals** first.

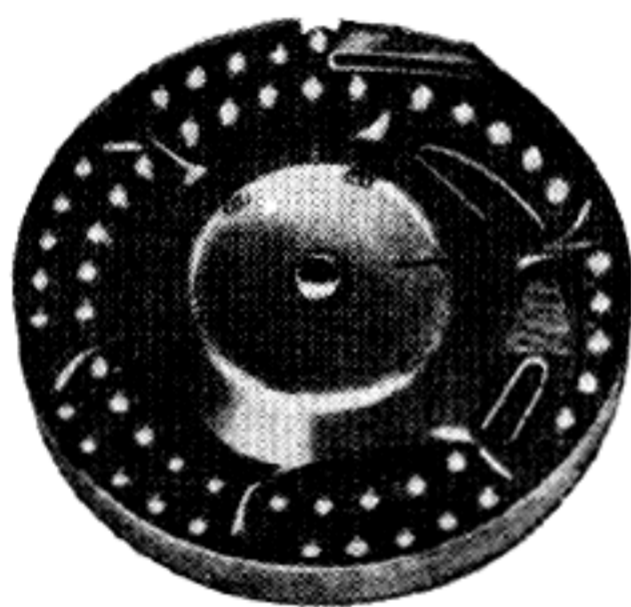

When correctly loaded, the first four sectors starting left from the magazine opening will contain 10 cartridges each, while the last two will have 5 each. **Warning.** Be careful not to insert any cartridges near the loops opposite the two sectors which hold five cartridges each; as any cartridges so placed will jam the magazine when the Rotor revolves. Now replace the magazine cover. Make sure that the large slot cut in it engages properly with the cover positioning stud. Slide the magazine key into place. Check to be sure that the stud on the spring correctly engages the center piece. Now wind the



key from left to right. As it turns you will hear a distinct click. Count the number of clicks. Stamped on the magazine cover you will find the correct number of clicks necessary to indicate sufficient spring tension to work the magazine properly. (The normal number is 9 or 10 for a 50 shot magazine.) **Note:** If magazine is not to be used at once, wind up **only two clicks** to assure proper locking of the magazine, and prevent straining spring. **Caution: Never rewind a partially empty magazine.** This is unnecessary and may break the magazine main spring.

## SPECIAL NOTE ON LOADING

**To insert box magazine:** Cock the gun, set the fire control lever for the type of fire desired. Put the safety on "safe." Insert rib at back of magazine in its recess at the front of the trigger guard and push in until the magazine catch engages with a click.

**Warning:** Remember that when the bolt goes forward in this weapon a cartridge is fired. Hence, if the weapon is not to be fired and you wish to move the bolt forward to prevent straining the recoil spring, first press down the magazine catch and remove the magazine from the gun. **Note:** While it is possible to insert the box type magazine in this gun with the action forward (that is, uncocked) this procedure is **not recommended**. In so inserting the magazine, make sure that the magazine catch is fully engaged because the overhang of the mag-

azine spring must be taken up before the engagement is securely locked.

**Inserting a Drum Magazine:** Cock the gun. Set fire control lever for "single" or "full auto" fire. Put safety on "Safe." Hold magazine so that key spring is facing **forward**. Now insert the two ribs on the magazine into their horizontal grooves in the receiver and slide the magazine into the gun from the **left hand side**. Push in until the magazine catch clicks into place. **Warning:** While this magazine may be inserted from the right side, it is unwise to do so as this may injure the magazine catch. Also, do not try to insert the magazine when the bolt is in forward position. The bottom of the bolt will strike against the mouth of the magazine and may injure it.



# U. S. THOMPSON .45 1928 SUBMACHINE GUN

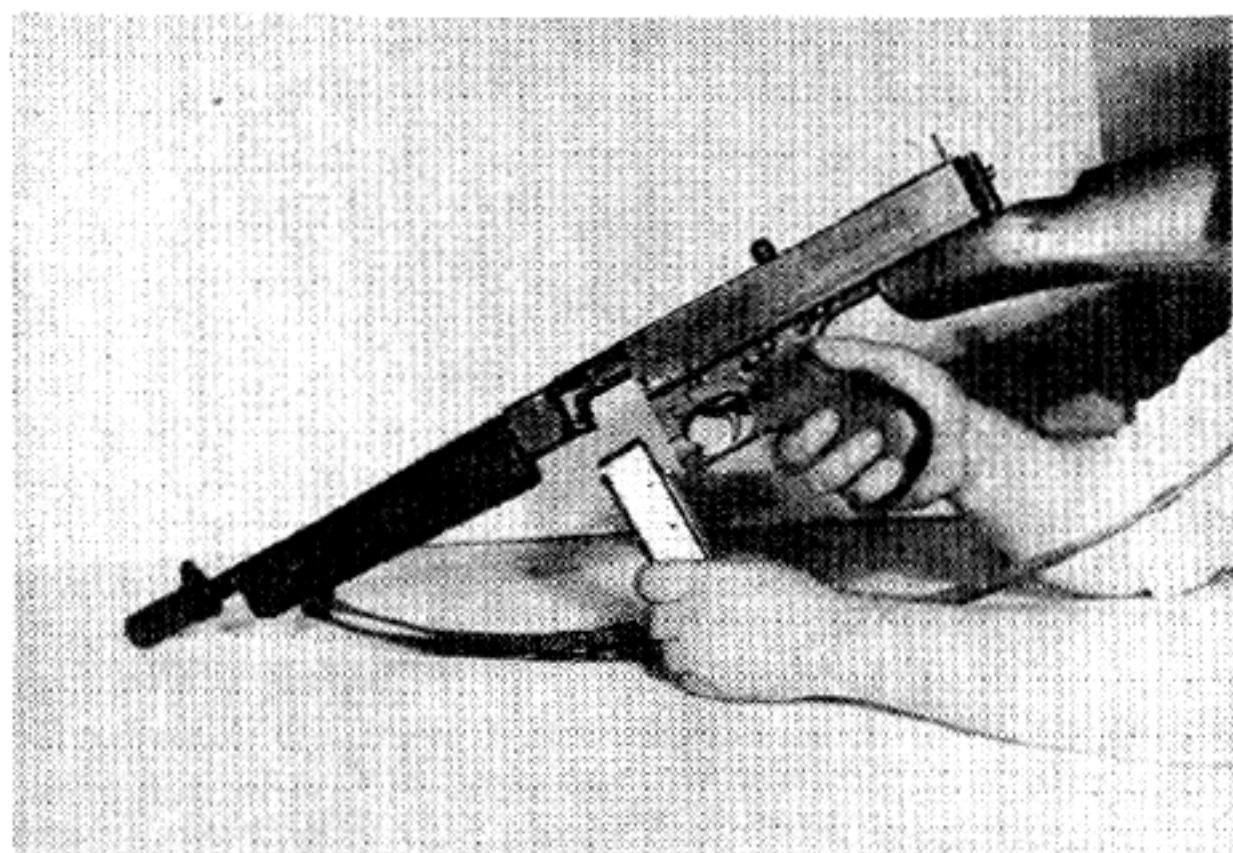

Remove magazine by pressing magazine catch up with the thumb and pulling 20-shot magazine straight down; or sliding 50-shot magazine out to the left.



Set safety on "Fire" and set fire control lever on "Full Auto." Remember this can only be done when the weapon is cocked.

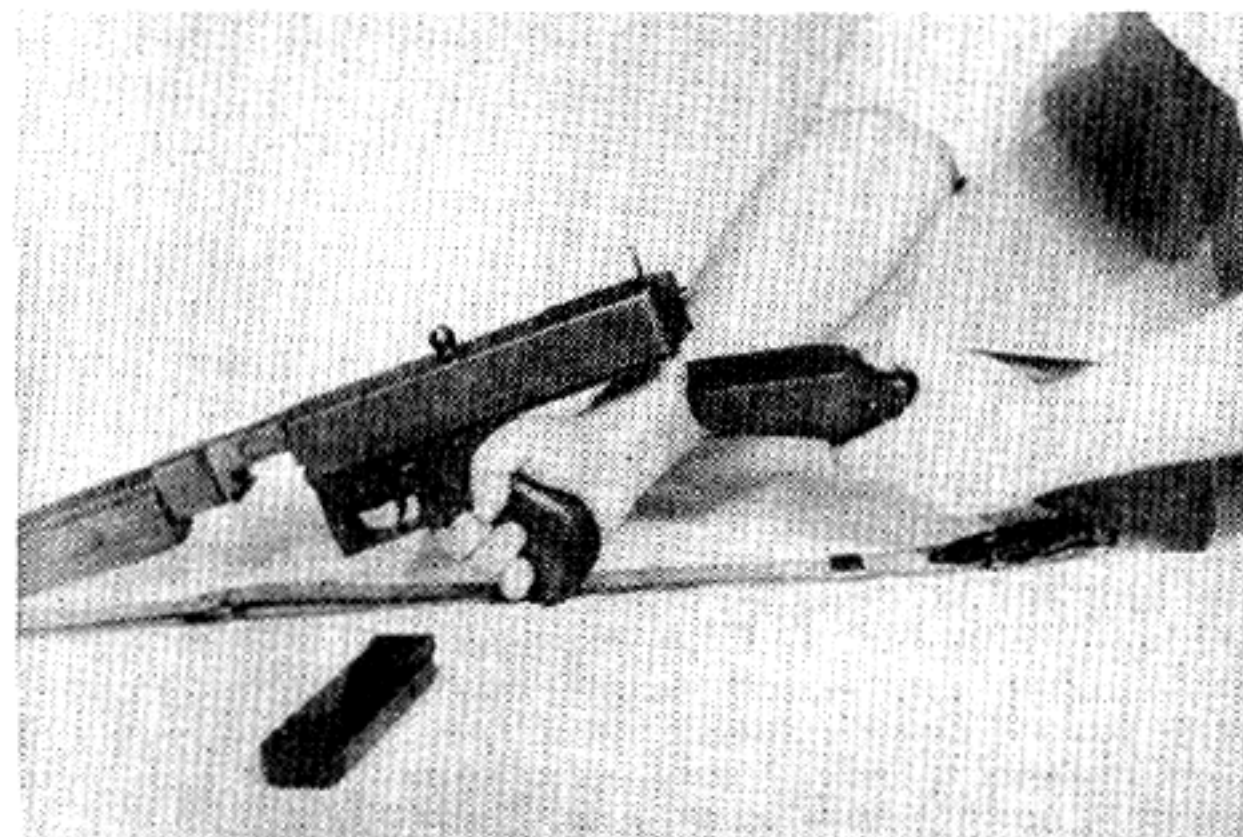

Remove buttstock by pressing its slide catch down and pulling stock straight to the rear out of its guide.

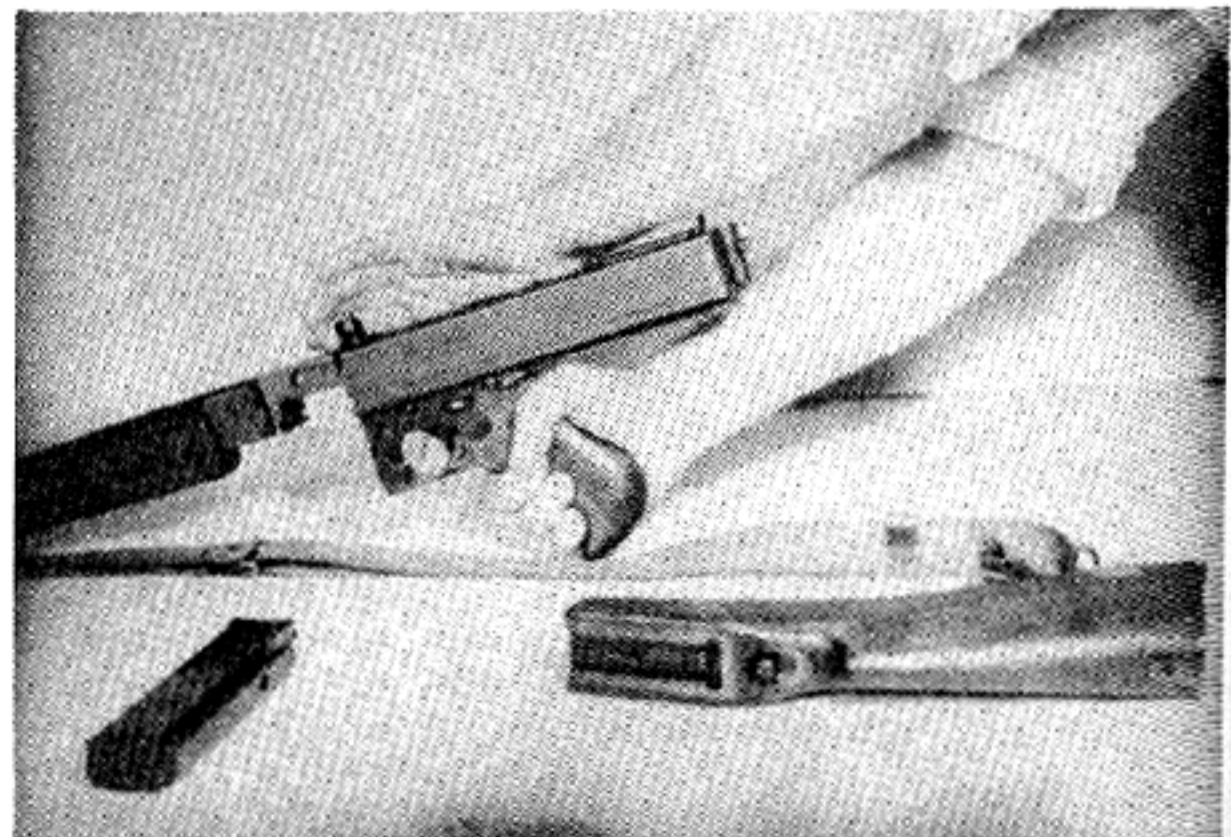

Hold firmly to actuator knob with left hand, pull trigger with right forefinger and ease bolt forward.

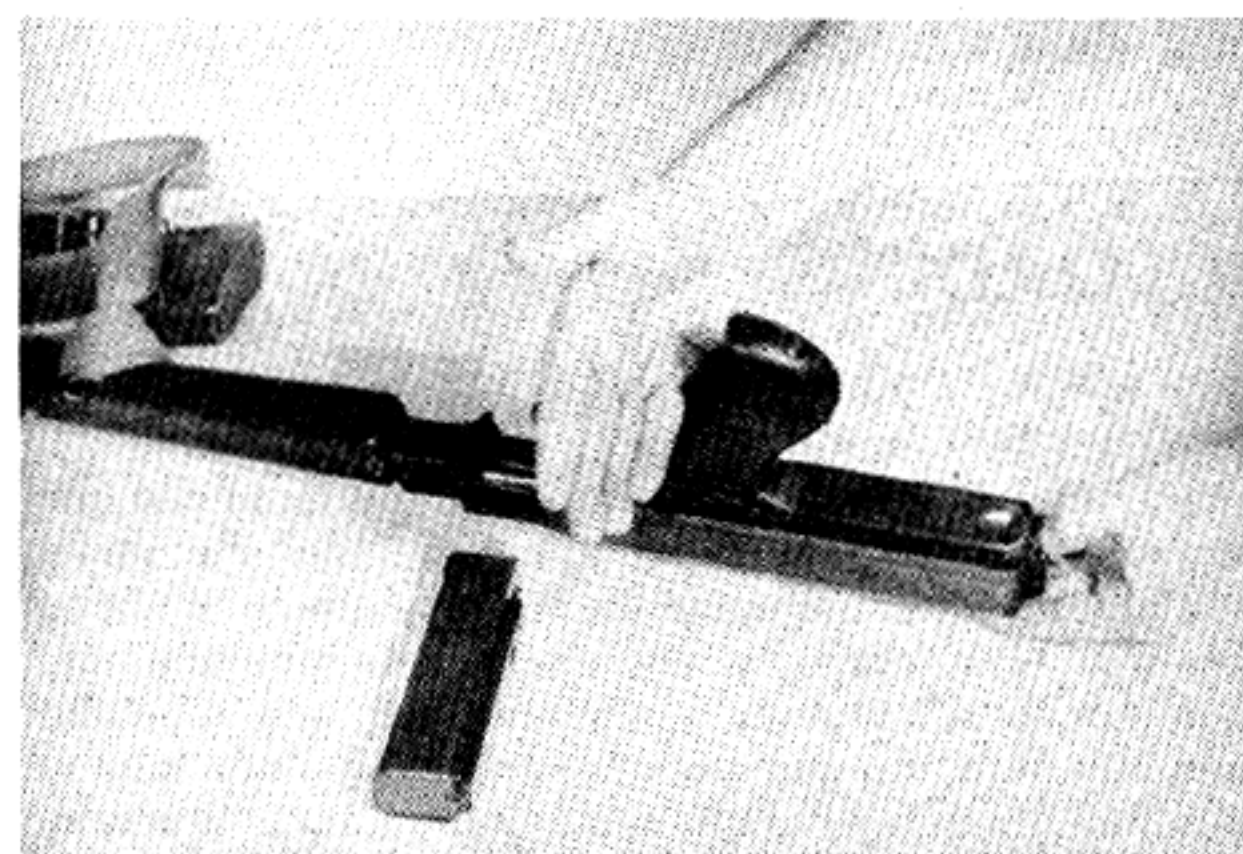

Turn gun upside down on table or knee. Push in the frame latch (the spring plunger on under side of frame behind pistol grip), and tap frame with right hand until it slides back a short distance.

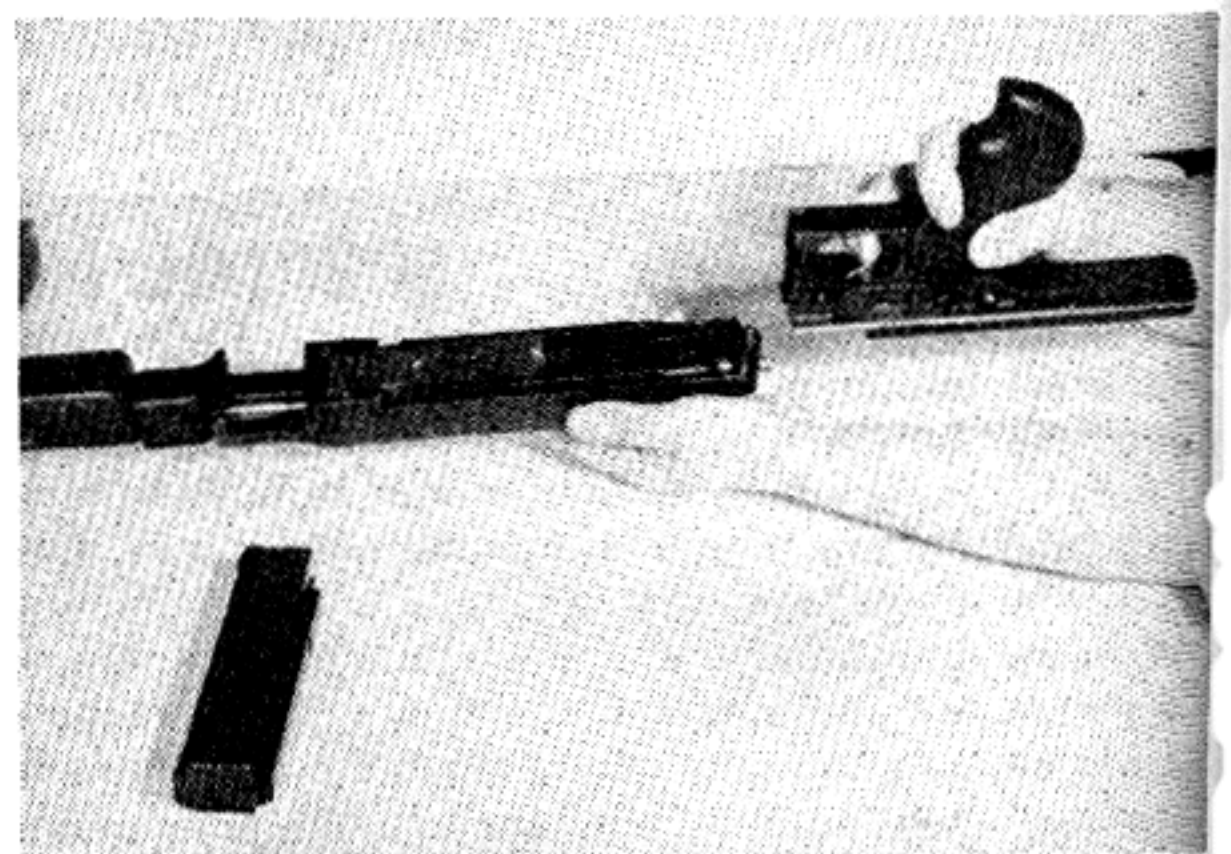

Grasp the rear grip with the right hand and pull the trigger holding the receiver firmly in the left hand, and slide the pistol grip group off out of its grooves.



# U. S. THOMPSON .45 1928 SUBMACHINE GUN

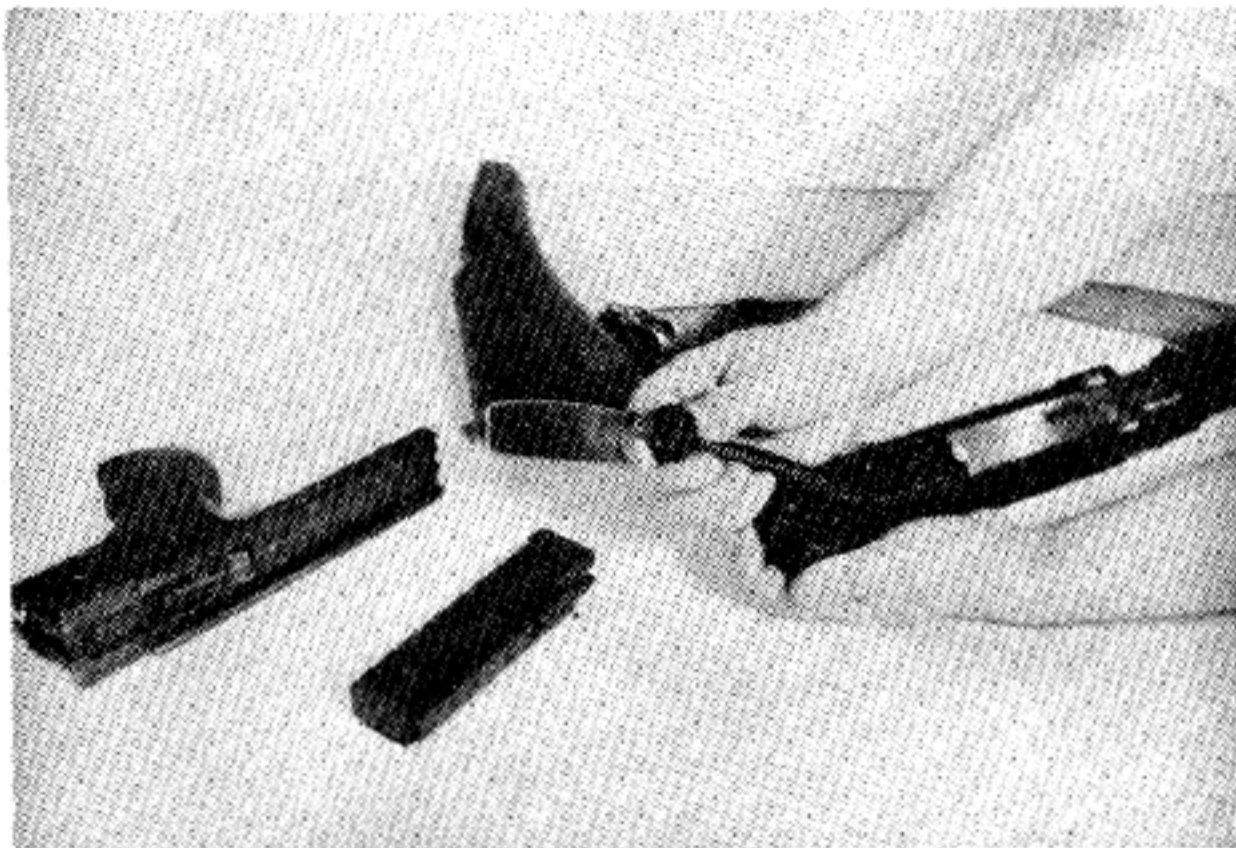

Remove recoil spring, as follows: With gun held firmly, turned **upside down**, grasp buffer flange with first and second fingers of right hand and pull out with upward and forward motion.

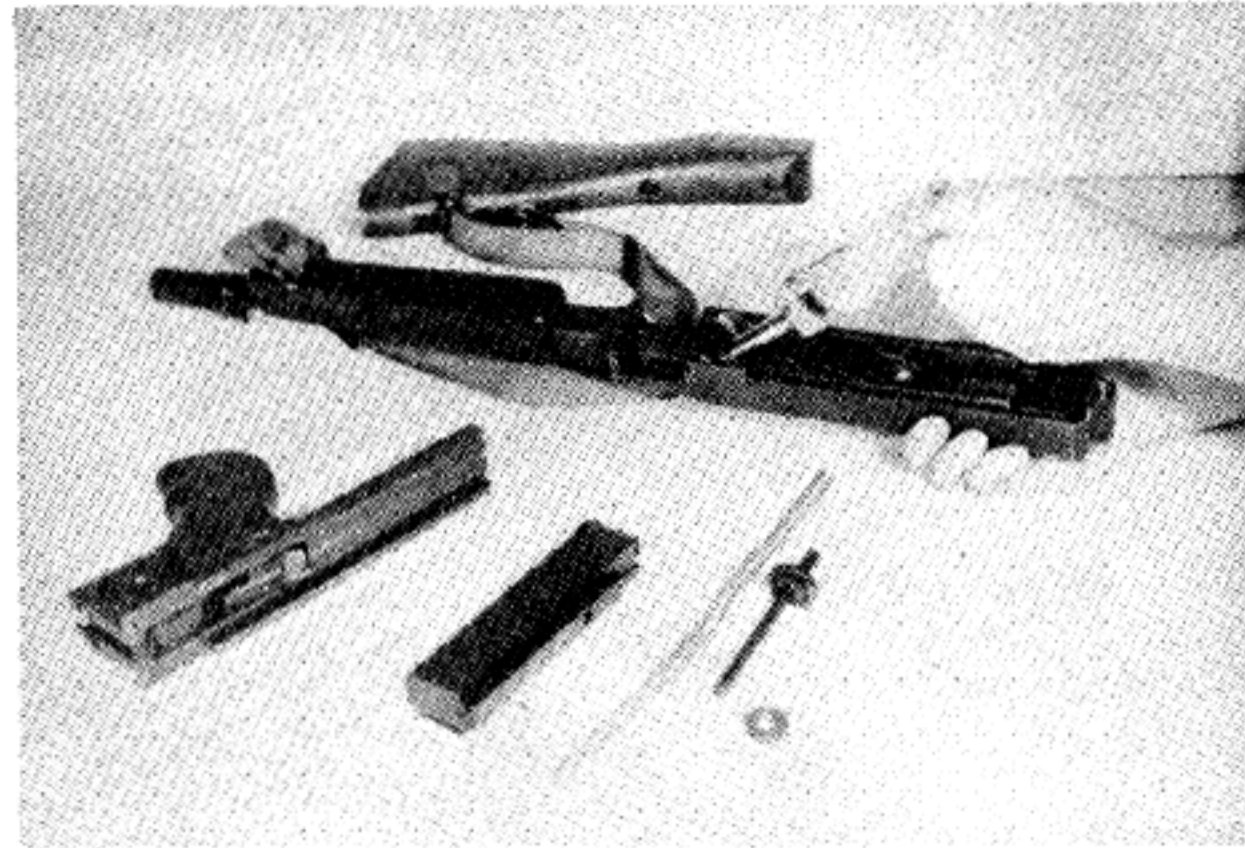

By pulling back on actuator knob, bolt is drawn back and can be removed to the rear.

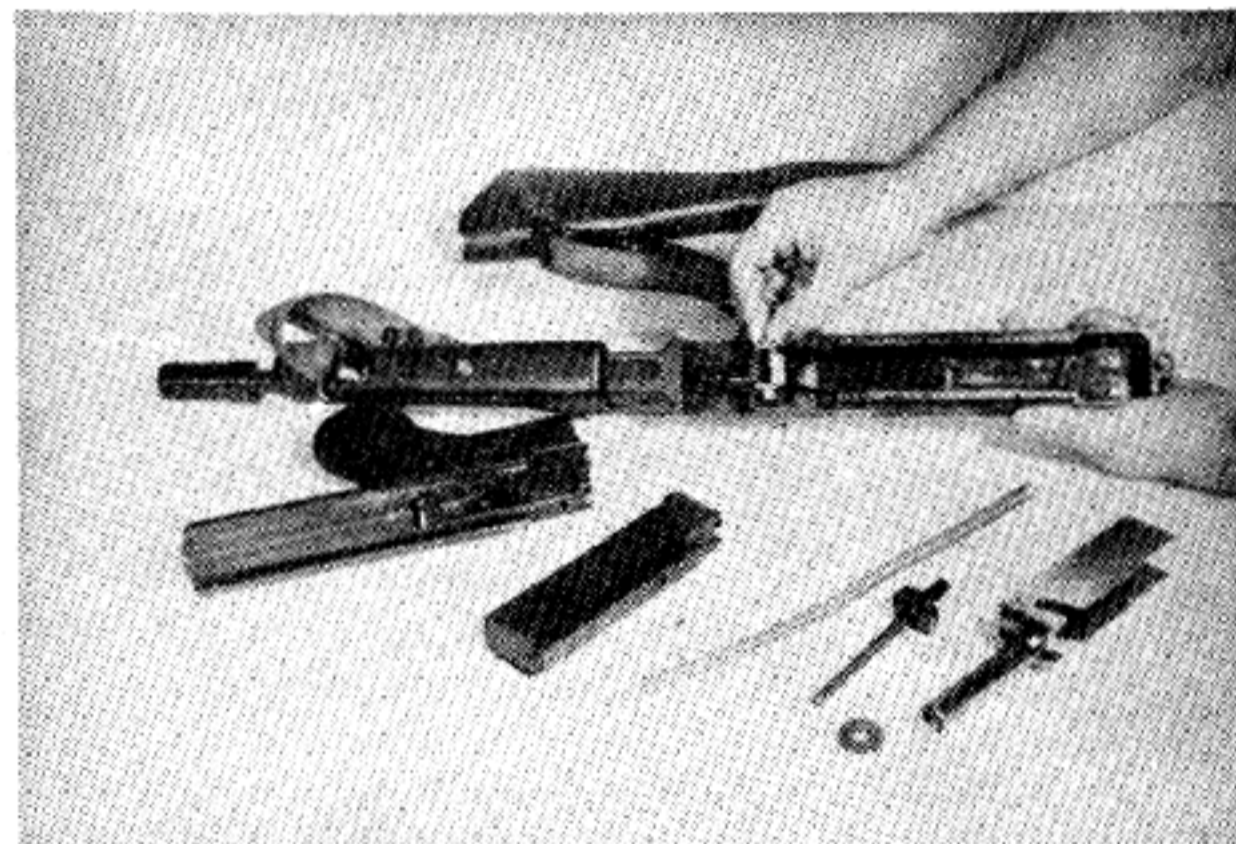

Actuator is then slipped forward with lock, and lock removed through its grooves in the receiver.

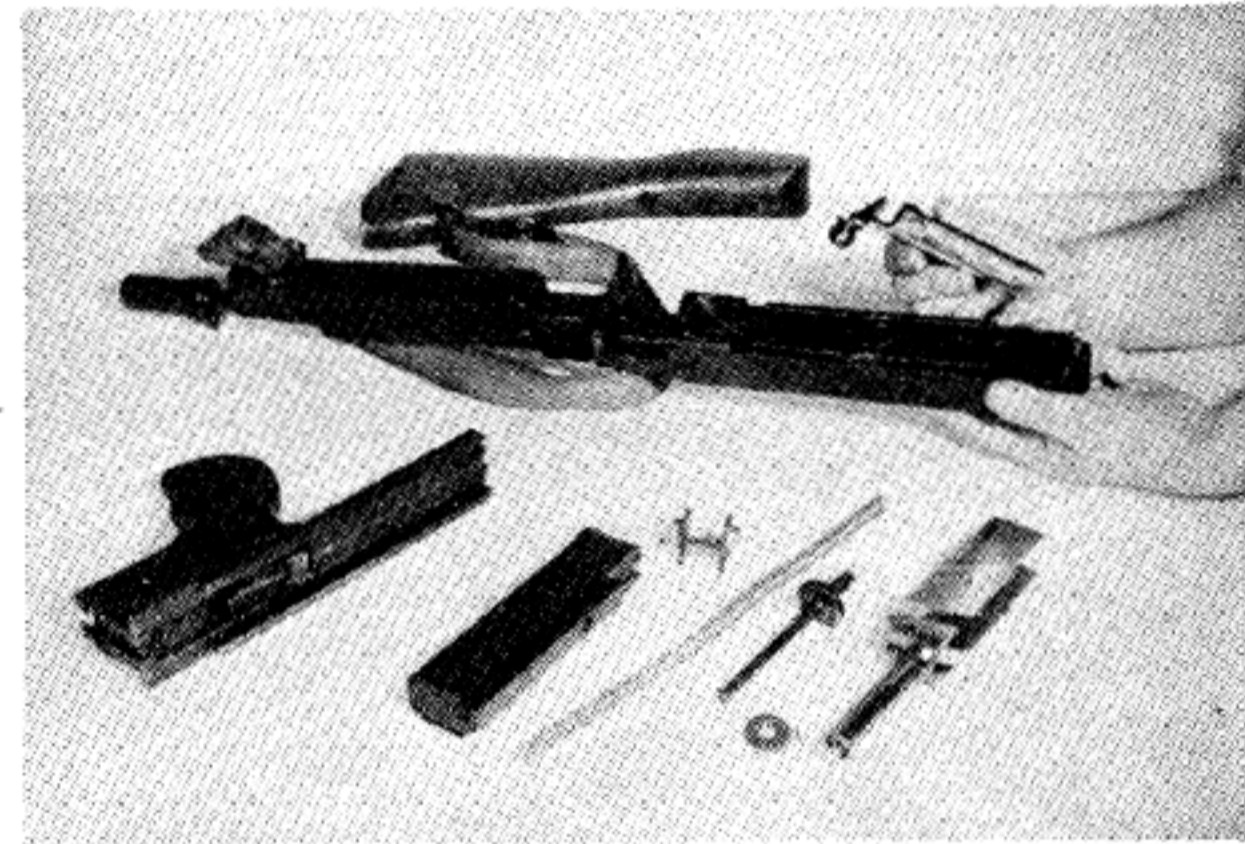

Then actuator itself is removed by sliding it to the rear.

This completes Field Stripping, no further dismounting is necessary.

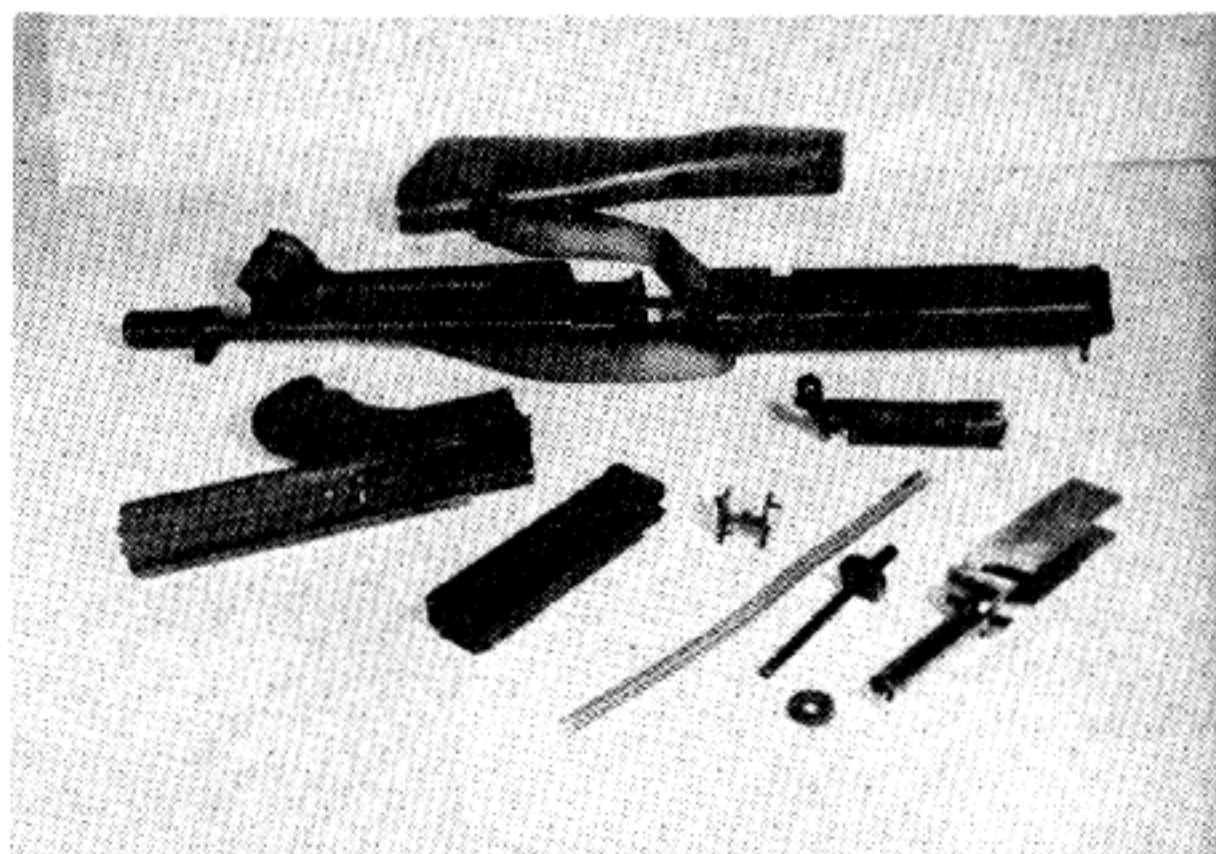

**Note:** On earlier models of this gun a special tool is required to remove the recoil spring. In this type, the stripping tool is inserted into its hole in the front end of the buffer rod. Then it is pushed in as far as it will go in the direction of the bolt. The rear end of the buffer rod is thus withdrawn from its hole at the rear end

of the receiver. By tilting this stripping tool, the buffer may be grasped by the hand, and the recoil spring, fiber buffer disc and rod will come out with the stripping tool. Buffer rod and spring are to be securely held so they do not fly apart.



# U. S. THOMPSON .45 1928 SUBMACHINE GUN

## NOTE ON ASSEMBLING

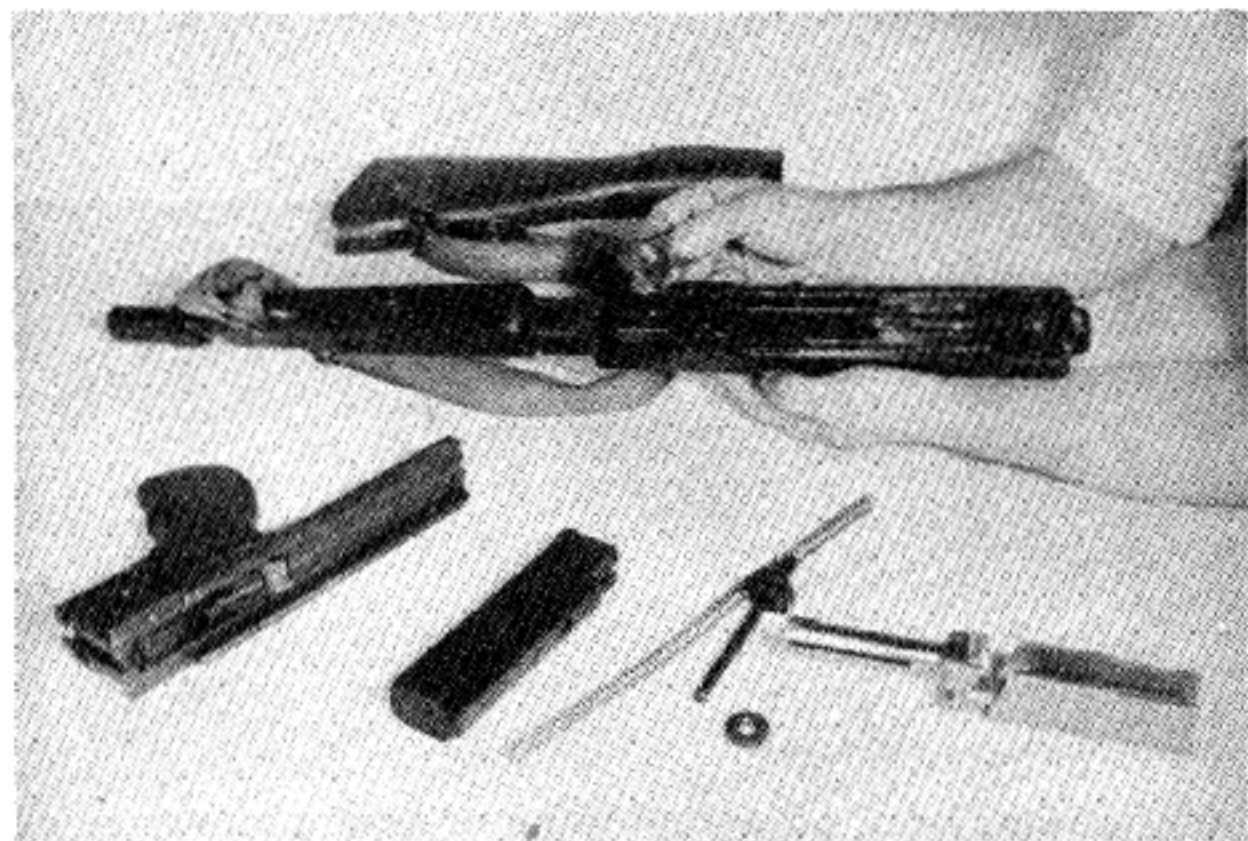

Inserting the actuator knob at its rear position, pull it forward and replace the lock which must be placed in its recesses in the receiver, so that the word "up" stamped on it is in uppermost position and the arrow stamped on it is pointing in the direction of the muzzle. The cross-piece of the lock (the lock is called the "H-Piece" because of its shape) must fit into the jaws of the actuator knob.

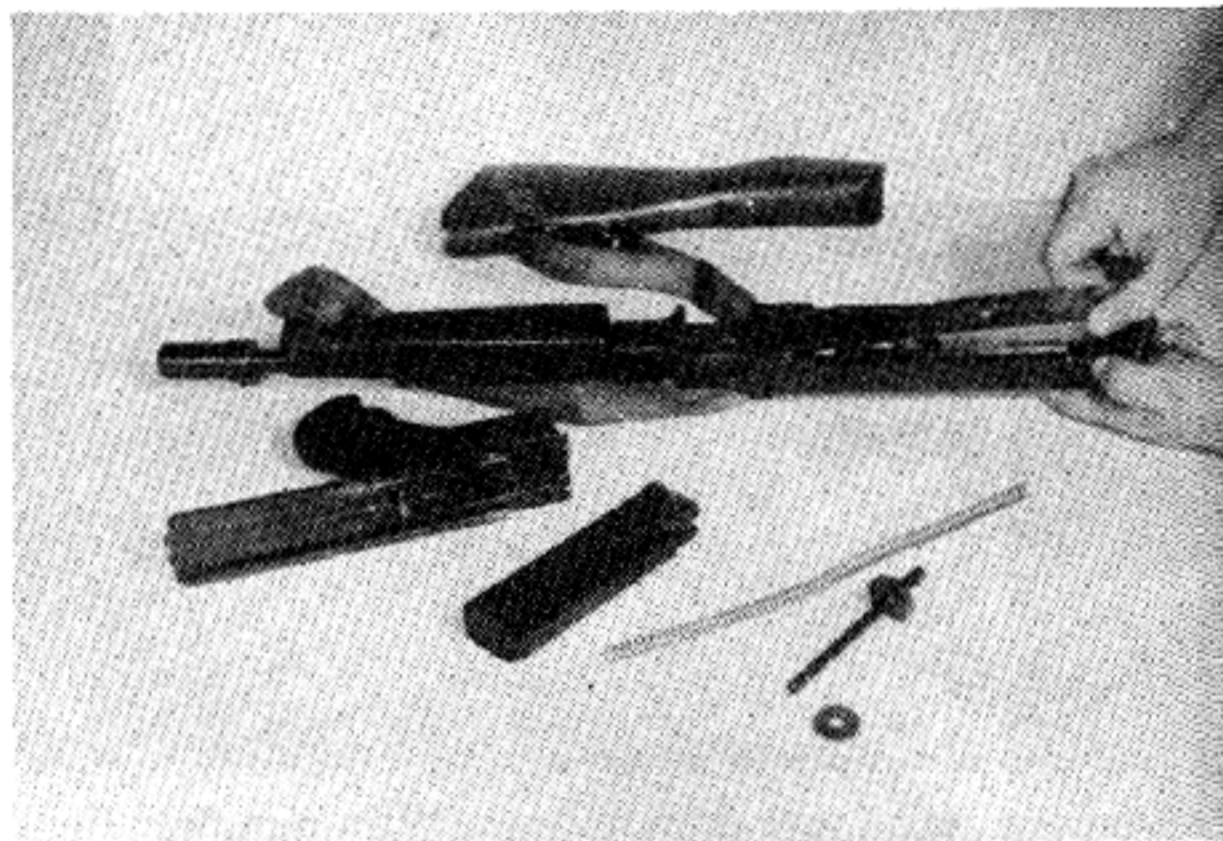

Pull the actuator and lock back and insert the bolt. Be sure and insert it bolt-end first so that the inclined cuts line up with the side members of the lock. (Now push the assembly forward as far as it will go.)

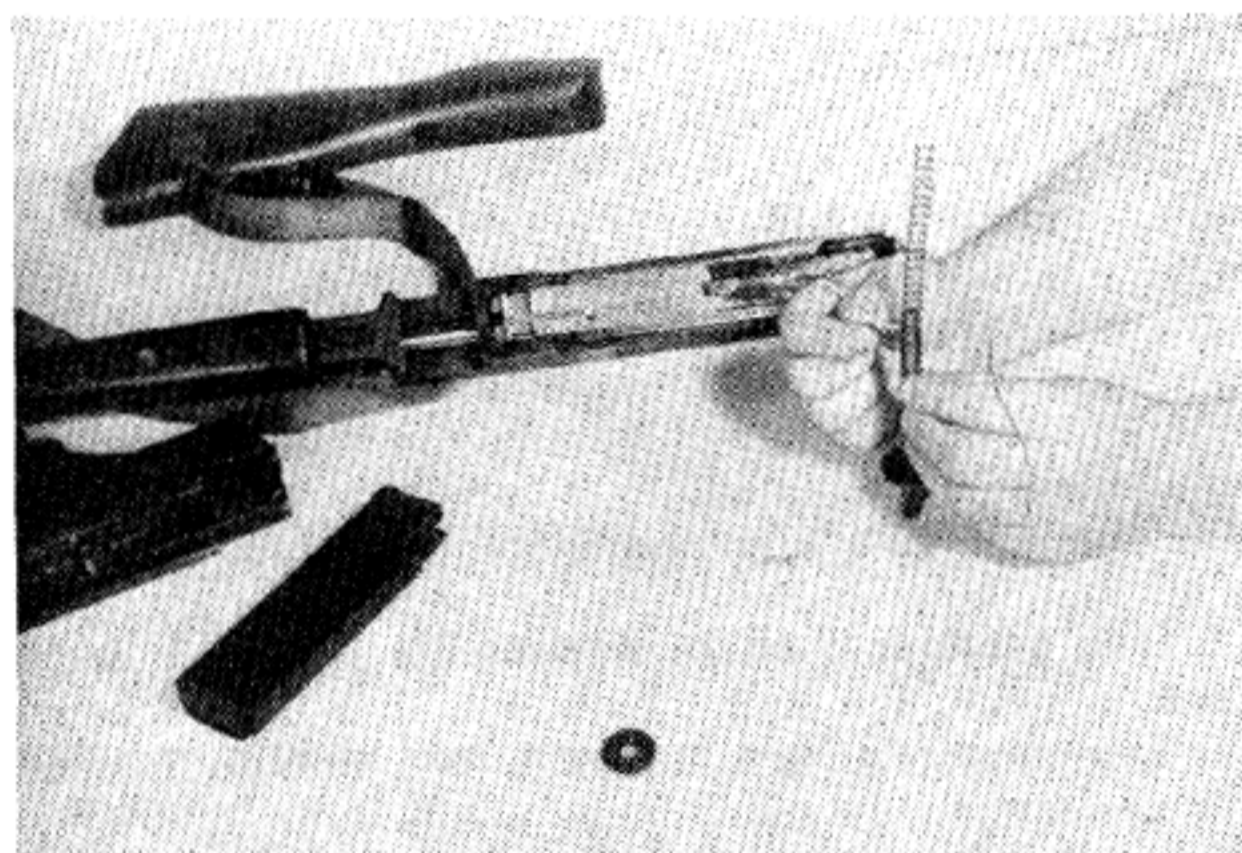

Compress the recoil spring over its rod, push it forward and down and push a nail or clip between the coils and through the hole in the rod.

Insert end of spring in hole in bolt; press rod forward until head of rod will slip into receiver and protrude through its hole to the rear; then withdraw nail.

**Note:** If the gun is the earlier model, put the recoil spring over its rod and push front end of spring into housing and rear of breech block. Compress recoil



spring on buffer rod a little at a time. While partly compressed, hold spring on rod with left hand and insert stripping tool into hole and buffer rod to retain spring in position. Replace fiber buffer disc and insert loose end of recoil spring in its hole in the actuator knob. Now place rear end of buffer rod in its hole at the rear end under receiver. Draw back actuator knob until rear of bolt touches stripping tool. Recoil spring will now enter proper holes. Withdraw stripping tool.

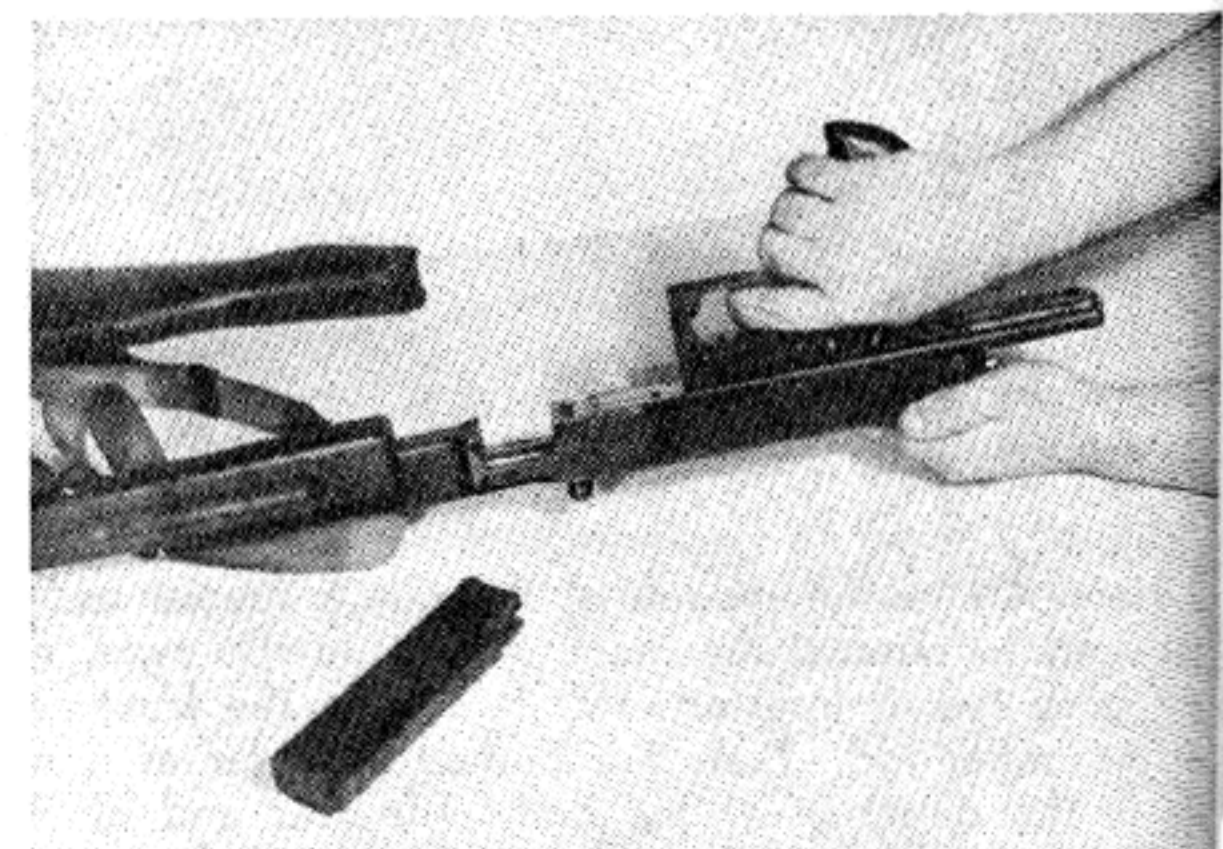

Holding the frame by the rear grip pull the trigger and slide the frame forward in its guide in the receiver. Remember that Safety must be at "Fire" position and fire control lever at "Full Auto."

Insert undercut of the frame in the buttstock and slide the butt forward until it locks in place.



# U. S. THOMPSON .45 1928 SUBMACHINE GUN

## HOW THE THOMPSON GUN WORKS

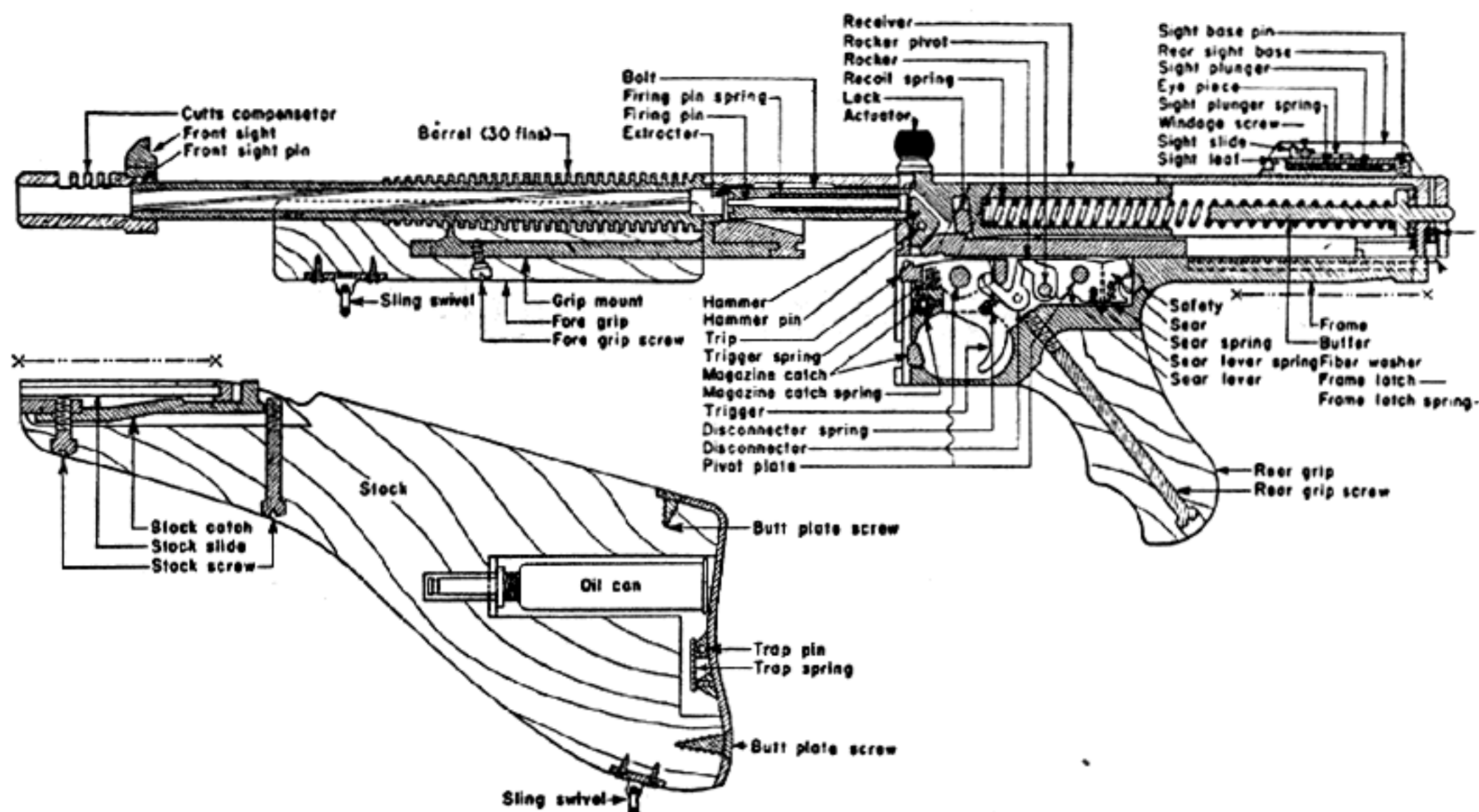

Starting with the Gun loaded and Cocked the action is as follows: When the trigger is pressed, it moves the disconnecter up to lift the sear lever. The sear lever raises the forward portion of sear, thus depressing the rear section and disengaging it from the notch on the bolt. The bolt is now free to be driven forward by the coiled recoil spring. If the fire control lever is set for semi-automatic fire, the rocker will act on the disconnecter and sear lever to leave the sear free to lodge in the bolt on backward motion.

In its forward motion the bolt strips the top cartridge from the magazine, forces it into the firing chamber and drives the lock downward into locked position. The forward end of the bolt is round to fit in the bolt wall of the receiver, and the rear portion is rectangular to fit into the receiver cavity.

The forward motion of the bolt is halted by the rec-

tangular end abutting against the receiver. The lock is an H-shaped piece of steel with lugs on each side; whose center is engaged by the actuator.

The hammer is pivoted in the bolt between the H-piece and the receiver bottom, and as the action closes, the lower end of this hammer strikes the abutment somewhat in advance of the bolt so that the cartridge is seated, the upper end of the hammer strikes the firing pin. (The hammer is made so it can strike the firing pin only when the bolt is completely locked.) The extractor snaps over the cannellure of the cartridge case.

**Return Movement of the Action:** The residual breech pressure forces the empty cartridge case back against the bolt, which in turn transmits the pressure to the H-piece locking device. This in turn transmits it to the locking surface of the receiver.

## HOW THE LOCK WORKS

The lock, or H-piece, is situated in a 70° inclined slot in the bolt; with its lugs engaged in short 45° grooves recessed in the receiver. When engaged in the short 45° inclined slot with the H-piece offering resistance to the backward motion of the bolt, resistance to this lifting action is offered by the forward inclined base of the H-piece meeting the rear face of the 70° inclined slot in the bolt itself. The rising of this H-shaped lock is further resisted because its bridge is thrust up into the slot in the actuator knob, which is set at an angle of 10° from the vertical, pointed to the rear.

The general direction of movement of the locking piece as a result of the movement of these several components, is upward and backward. Thus the bolt is prevented from moving to the rear while the chamber pressure is dangerous.

Because of the rapidity with which the pressure in the bore rises to its maximum on firing, the bolt is said to be supported by adhesion of the inclined surfaces until the pressure has again dropped materially, which acts as a breech locking factor.

For this adhesion lock to work, it is essential that the engaging surfaces remain constantly lubricated, by the oil pads in the receiver.

**Note:** Engineers disagree as to the actual value of this locking system. The necessity for constant oiling, incidentally, is a source of jams. Regardless of the real or theoretical value of the locking device, the fact remains that the weight of the parts themselves and the inertia of the recoil spring are sufficient to work the weapon safely and satisfactorily when the locking device is removed from the gun.



# U. S. THOMPSON .45 1928 SUBMACHINE GUN

## RETURN MOVEMENT OF THE ACTION

The forward end of the recoil spring is housed in a cavity in the actuator. The buffer forms a guide for the rear end of the recoil spring, permitting it to compress in a straight line as the action goes backward. A fiber washer is provided to absorb the shock of recoil, and oil pads in the receiver lubricate the locking lugs and bolt sides during the passage of those pieces.

The extractor, which is positioned on the right forward end of the bolt, draws the empty case out of the firing

chamber until it strikes the ejector which moves into a clearance cut in the bolt path and hurls it out on the ejection port.

If a box type magazine is in the weapon, the magazine spring forces cartridges up in line bringing the next cartridge into position for the forward movement of the bolt. If the drum magazine is being used, springs inside the drum twist the spiral and feed a cartridge into line.

## STOPPAGES AND IMMEDIATE ACTION

It is essential that this weapon be kept properly oiled. When considerable dust is present, care must be taken that the supply of oil is **very low**. All surfaces of the receiver, bolt extractor and ejector having contact with powder gases should be cleaned as soon after firing as possible in a solution of a quarter-pound sal soda to a pint of very hot water. Boiling water will suffice if there is no sal soda available. Parts must then be thoroughly dried and well oiled. Give special attention to cleaning the compensator attached to the muzzle. Firing will fill the escape slots in the compensator with burnt powder residue which will interfere with the efficiency of the compensator. This will radically effect the sighting of the weapon as well as increase the recoil.

Considerably more attention must be paid to oiling the working surfaces of this gun than to the average blowback-type of submachine gun. Since the cartridge cases are lubricated as they are fed into the firing chamber, there is a tendency for oil and residue to cake there; and the breech cleaning bristol brush supplied with the gun should be used to clear the firing chamber, whenever possible.

### FAILURE TO EXTRACT

Failure to extract or eject will usually indicate a weak or broken extractor, or poor ammunition. If the extractor is broken, the bolt traveling forward will feed another cartridge, jamming the weapon. To clear such a condition, draw the bolt to the rear, and remove the magazine, allowing the live cartridge to slide out of

the receiver. Empty case may then be punched out or pried out. It will be necessary to extract the bolt and replace the extractor to correct the condition.

If the ammunition is weak, usually indicating old ammunition, the feed of the forward motion of the bolt will be slowed and the cartridge will not feed from magazine into the firing chamber. In this case, the bolt should be drawn rapidly to the rear to throw out the misfire.

If cartridge fails to fire due to defective primer (a condition often caused by oil seeping in around the primer seat), rapidly pull the bolt back as far as it will go to let the next round rise in line.

### MAGAZINE TROUBLE

If mouth of magazine has been damaged, round will not feed up correctly. It is necessary to insert a perfect magazine. If cartridge fails to feed because it has not been properly positioned in the magazine, slip it out of the magazine, allow the next one to go into place and return magazine to firing position. Should this type of stoppage continue, replace with new magazine and oil weapon at first opportunity.

### DENT IN MAGAZINE

Mishandling the magazines will often dent the walls. In such a case the rising magazine spring may be interfered with, or the follower may be stopped by the dent and cause poor feeding. The remedy here is to replace the magazine.

## THOMPSON SUBMACHINE GUN M1

This is the latest model of the Thompson Submachine Gun manufactured for the United States Army. While it looks very much like the Thompson 1928 A1, actually it is a very much simpler, sturdier, and cheaper weapon. The bolt in the M1 model is heavier than the bolt in the earlier type.

This model eliminates the useless lock, actuator and breech oiler of the earlier models. This design is further simplified by eliminating the cooling fins on the barrel. No compensator is issued with this gun.

While many of the parts are interchangeable in these two guns, it must be noted that the earlier models use the complicated Blish system which theoretically locks the weapon by adhesion at the moment of firing. The M1 type, which is simpler in all respects, makes no

pretensions to being anything more than the safe, sturdy, blowback weapon that it is. The bolt handle travels in a slot cut on the right hand side of the receiver.

While the frame looks like the 1928 A1 model, it differs in that the buttstock is permanently attached by screws and cannot be slid off as can the one in the model 1928.

While the design of the safety and the rocket pivot have been changed they perform the same functions as the corresponding parts in the earlier model.

This gun will take straight line box magazine holding 20 and 30 cartridges. **The drum magazine cannot be used on this gun.**



# U. S. THOMPSON .45 1928 SUBMACHINE GUN

## FIELD STRIPPING

The instructions given for dismounting the 1928 A1 will effectively cover the stripping of this weapon through removal of frame from receiver.

In removing the recoil spring from this weapon, place the gun so that the open side of the receiver is facing you. Press the buffer pilot down until it is flush with the end of the receiver and remove the buffer pad. Keeping the buffer pilot flush with the outside of the receiver, push the bolt handle forward about half way in the slot. This will prevent damaging the recoil

spring as it and the buffer pilot are removed from the receiver.

Now pull the bolt handle back until it is in the center of the half circle in the receiver slot. Lift the rear end of the bolt up until the handle is in the center of this circle. Push the hammer to the rear until it is flush with the shoulder of the bolt. The bolt handle can now be removed from the side and the bolt drawn back out of the receiver.

## FIELD ASSEMBLING

Assemble the buffer pilot to the recoil spring and holding the gun on the knee insert the recoil spring through the buffer pilot hole in the receiver from the outside, permitting the recoil spring to slide into the hole in the bolt.

Replace the bolt in the receiver so the bolt handle hole is in the center of the half circle in the receiver slot. Push the back end of the bolt up slightly out of the receiver. Push the hammer back against the shoulder of the bolt and the bolt handle can then be inserted. Then slide the bolt forward.

Now move the bolt halfway in the middle of the receiver, and assemble the buffer pilot with the recoil spring into the receiver and bolt.

When the end of the buffer pilot is flush with the outside of the receiver, the buffer pad can be placed over the buffer.

### NOTE

The forearms on the regular U. S. Service Models of the Thompson are of regular carbine type.

On commercial and British Service Models, instead of the regular type handguard the guns have an additional pistol grip below the barrel for holding with the left hand.

Except that the rate of fire is usually higher in the commercial models, there are no other differences in the types; and parts are interchangeable.



# U. S. .45 M3 SUBMACHINE GUN

This weapon was developed by our Ordnance Department to fill the need for a rugged ultra-reliable sub-machine gun low in cost and simple to manufacture. It is the United States' answer to the British Sten gun and the German Schmeisser machine pistol 38. This weapon embodies the very latest design in submachine weapons. It incorporates every valuable characteristic of other submachine weapons and has a series of special features not found in other guns. It is crude in appearance, because of the extremely low cost of its manufacture. But it is definitely superior to any other submachine gun made anywhere. Its cost is less than that of a good automatic pistol.

**Caliber:** 45 M 1911 cartridge, ball and tracer ammunition.

**Magazine:** Box magazine positioned under receiver, capacity 30 cartridges.

**Muzzle Velocity Cartridge:** About 920 feet per second.

**Ballistic Date:** About same for other submachine weapons using this cartridge.

**Barrel Length:** 8"

**Overall Length of Gun:**

**Weight:** About 6 lbs.

**Sights:** Fixed. Aperture rear sight.

**Range:** Standard for this type of weapon and cartridge. About 300 yards.

**Gun Operated by:** Backward pressure of gases against fired cartridge case in chamber.

**Locked:** Simple blowback, unlocked. Heavy bolt and return spring delay opening of breech until bullet has left barrel. An added factor in this weapon is a fixed firing pin in the bolt, so constructed that excess energy from its forward movement is expended si-

multaneously with the explosion of the powder. This feature also gives greatly improved accuracy, because it is largely responsible for the fact that the gun does not climb, as do other weapons of this type, during rapid fire.

**Cooled:** Bolt remains open between shots permitting air to circulate through breech and barrel.

**Position of Cocking Handle:** A rocker arm on right side of gun just behind magazine housing. Pulling this back draws bolt back to full cock.

**Special Feature:** This rocker arm, when pushed forward while bolt is back, stays in forward position while firing. Cocking handles in most other submachine guns travel back and forth with each movement of the bolt. This is often a disturbing factor for firer.

**Type of Fire:** Full automatic only.

**Rate of Fire:** 450 rounds per minute. This is very nearly the ideal rate for submachine use in full automatic fire. Gun was deliberately slowed down to this figure.

**Breech Cover:** Another special feature on this weapon is a hinged breech cover which springs open when the rocker arm is pulled back to cock the bolt. This provides added protection for the working mechanism, and keeps dirt out of the action. This cover, as explained later, is also a Safety.

**Stock:** A skeleton stock is provided. This skeleton is of heavy wire stock and slides into tubes on the side of the frame when not in use. In this position it is exceptionally compact and the gun may be used as a machine pistol. Pulling out these heavy wires provides a shoulder stock, converting the weapon to a full sub-machine gun.

## HOW THE M-3 SUBMACHINE WORKS

A loaded magazine being pushed into the magazine housing from below until it locks, the rocker arm is drawn back as far as it will go. This draws back the bolt, compresses the recoil springs and engages the sear in the bolt holding it in rearward position. At the same time the cover over the ejection port flies open. Pressure on the trigger will now release the bolt which will drive forward, forcing the cartridge from the magazine into the firing chamber, slipping the extractor over the head of the cartridge case, and firing the cartridge.

Inertia keeps the action closed until the bullet has left the barrel. Then the heavy bolt travels back in a straight line, the extractor pulls out the empty cartridge case, which strikes against the ejector and is hurled out the ejection port as the bolt travels straight to the rear compressing the recoil springs. If the trigger has been released the sear catches in the bolt holding it in rearward position. If trigger is kept pressed, bolt will go forward again and repeat the cycle as long as the trigger is held

and there are any cartridges in the magazine.

**Special Note:** The ejection port cover is also a safety. It operates on hinges, but when snapped into closed safety position while bolt is cocked, it holds the bolt back off the sear, thus rendering sear and trigger ineffective. It may also be used to lock the bolt in its forward position, acting as a dust cover to keep out dirt, leaves and the like and to shield the bolt from damage.

Except for the Australian Owen and Austen sub-machine guns, this is the only weapon of this type which permits simple barrel removal. A heavy flange is provided at the end of the barrel to permit it to be unscrewed. This feature, together with its simple takedown, permits it to be readily adapted (by merely inserting a special bolt and a special barrel) to use of the 9mm Parabellum cartridge so widely used throughout Europe by the German, Italian, and Russian armies, and also in the British Sten and Lanchester submachine guns.



# U. S. .45 M3 SUBMACHINE GUN





# U. S. BROWNING .30 1918 AND 1918 A1 AUTOMATIC RIFLE

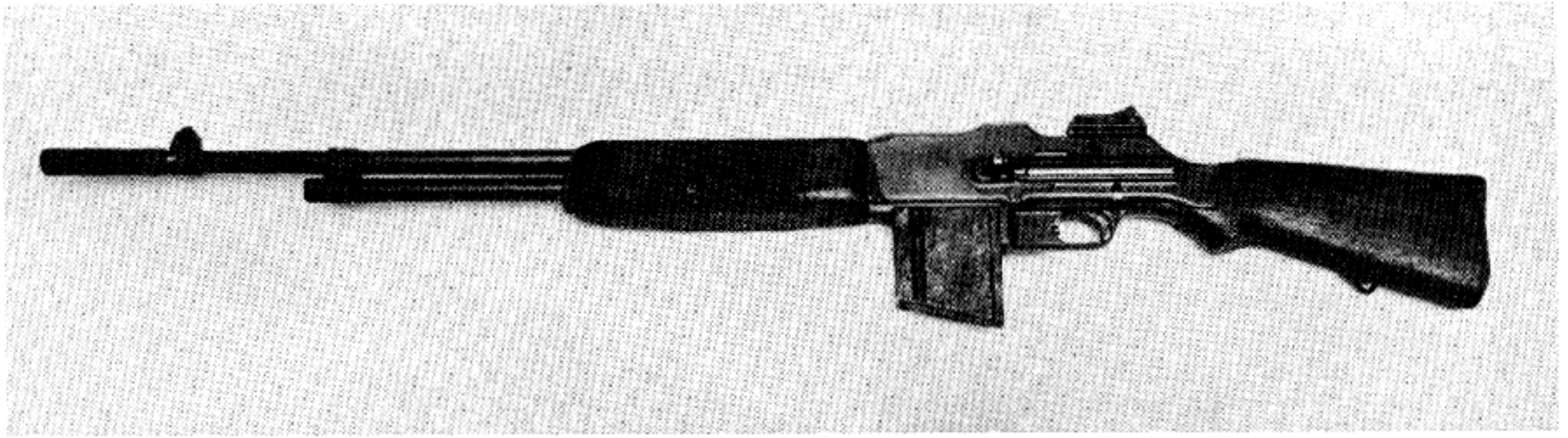

**Caliber:** .30, Model 1906 or M1.

**Magazine:** Detachable box type, holding 20 cartridges in staggered line. Magazine positioned directly under receiver.

**Muzzle Velocity of Cartridge:** About 2680 feet per second.

**Weight of Bullet:** 150 grains, full jacketed.

**Barrel Length:** 24".

**Overall Length of Gun:** 47".

**Weight Without Magazine:** 15½ lbs.

**Weight of Loaded Magazine:** 1 lb. 7 ozs.

**Sights:** Blade front sight, aperture rear sight, graduated to 1600 yds.

**Accurate Range:** About 600 yds.

**Rifle Operated by:** Gas escaping through small hole in underside of barrel into an expansion chamber where it forces back a piston under the barrel operating the action and compressing the recoil spring.

**Locked:** By rising bolt lock which locks into recesses in the top of the receiver. A slide screwed to the piston, contains the hammer which is connected to the link

which in turn is attached to the bolt. As the slide moves to the rear, it causes the link to pull the bolt lock and bolt from their recesses.

**Cooled:** Air cooled. Bolt remains open between shots permitting air circulation through breech end down barrel.

**Cyclic Rate of Fire:** About 500 per minute.

**Normal Rate of Fire:** 40 to 60 shots per minute, semi-automatic. It is possible to deliver 150 shots per minute semi-automatic with this weapon.

**Note:** Maximum full automatic rate is 600 per minute.

**Position of Operating Handle:** On left hand of receiver above trigger guard. Drawing this back cocks the hammer; the operating handle should then be pushed back to its forward position. It is not connected with the cocking mechanism in its forward motion.

**Flash Hider:** This is a metal tube extending beyond the muzzle of the weapon, to hide the flash caused by powder burning after it leaves the muzzle of the barrel.

## INSTRUCTIONS FOR LOADING AND FIRING

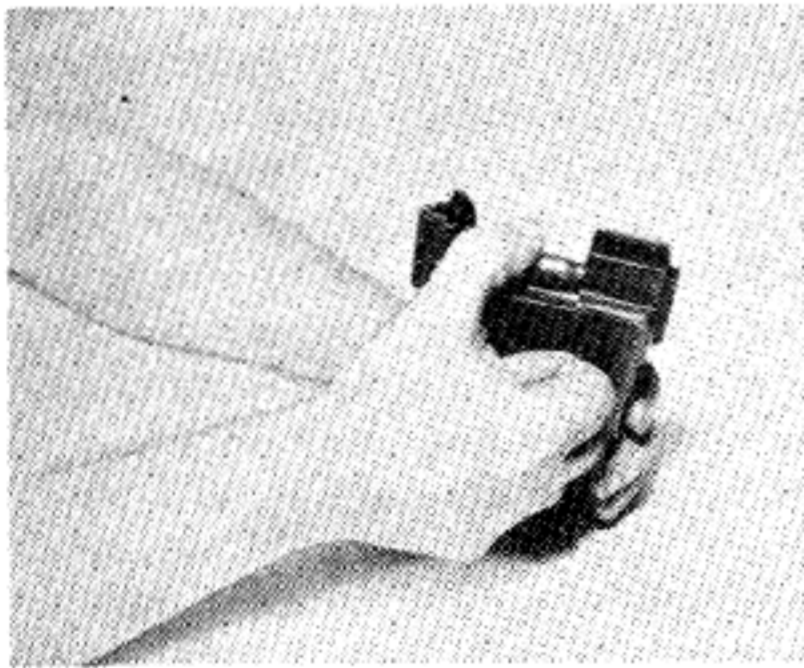

If a magazine filler is available, place the wide end over the top of the magazine, so the grooves fit over the magazine catch rib. Insert a clip of cartridges in the filler and with the right thumb strip the cartridges into the magazine exactly as though

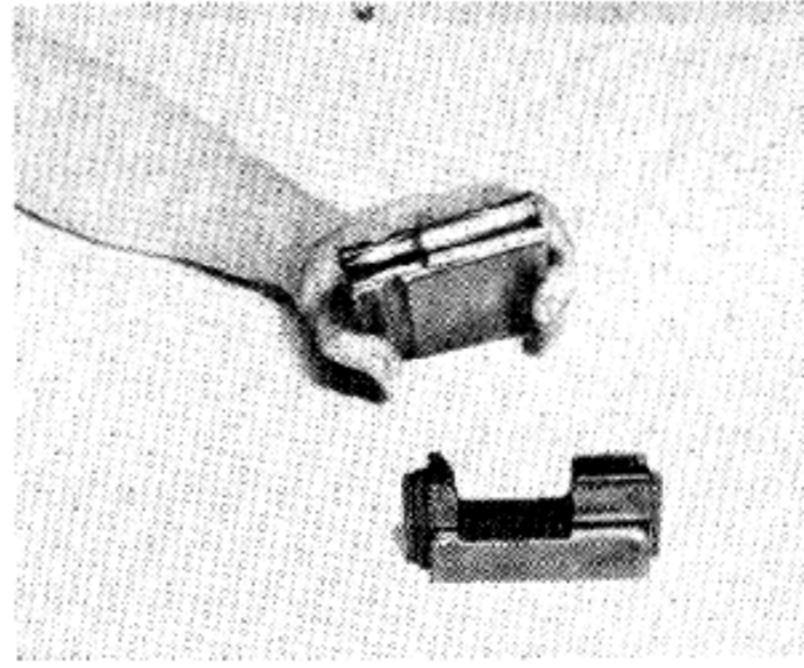

they were being fed into a bolt action rifle. Single cartridges may be so loaded. If no filler is available, cartridges may be loaded singly into the magazine as for automatic pistol.

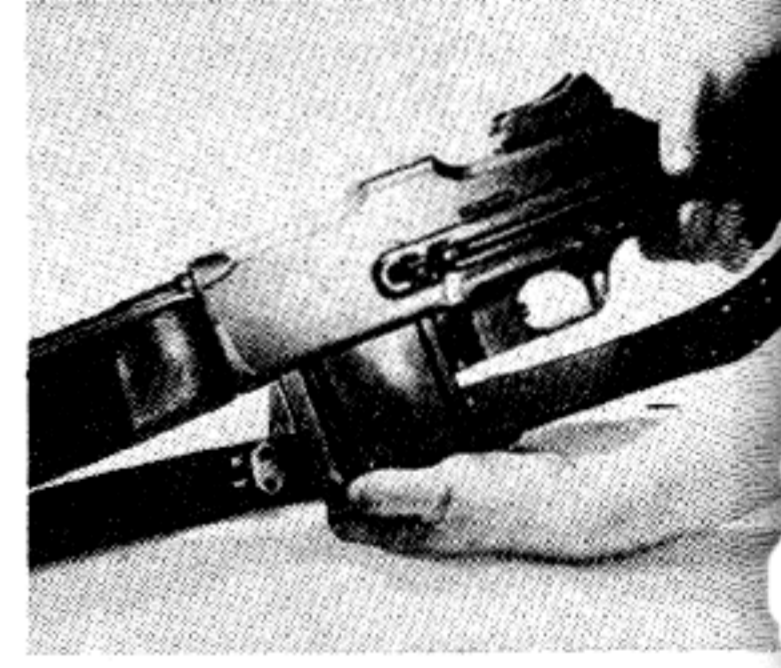

Insert magazine between sides of receiver in front of the trigger guard and push home until it locks. This will normally be done with the right hand. While the magazine may be inserted with the weapon uncocked, it will ordinarily be done after the rifle has been cocked and set on "safe."



# U. S. BROWNING .30 1918 AND 1918 A1 AUTOMATIC RIFLE

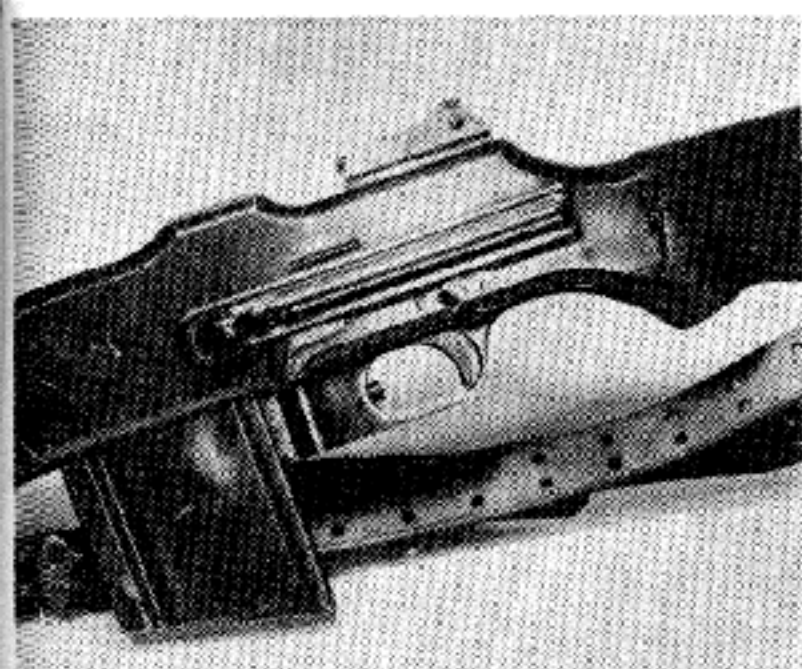

**Fire control:** The change lever is directly above the trigger. Push this lever all the way forward to the direction of the letter "F", and the rifle will fire one shot each time you pull the trigger. Set this lever in the vertical position covering the letter "A" for full automatic fire. (Note: On 1918-A1 Model, no single shot fire. The "F" gives slow rate; while "A" gives high rate.) Push in the small change lever stop, and push the change lever back and over the stop as far as it will go in the direction of the letter "S" and the weapon is safe and cannot be fired. This change lever stop prevents the weapon being set on "safe" without the knowledge of the firer; and it permits a quick change to the full automatic or single shot position.

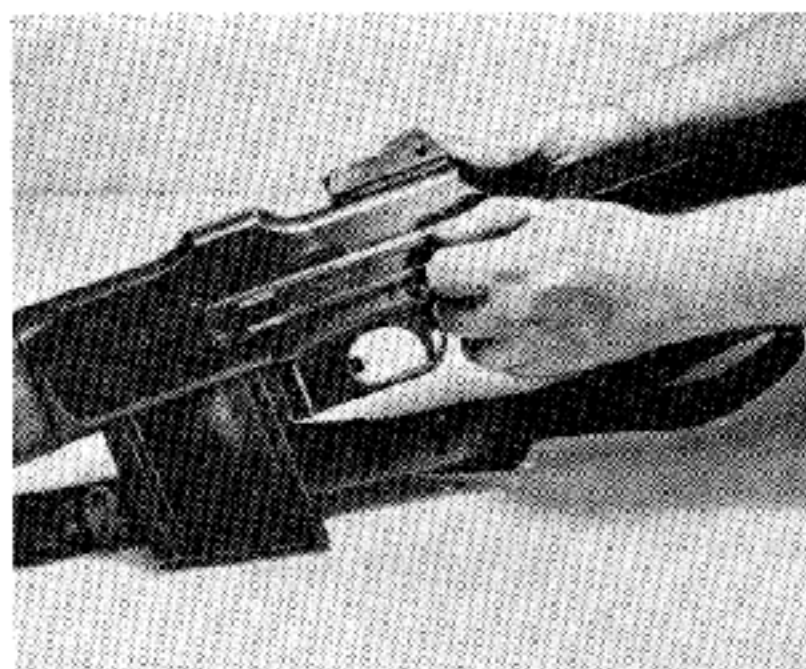

Drawing back the operating handle as far as it will go, cocks the weapon and compresses the recoil spring. Pushing it forward makes it unnecessary for the action to carry the handle to the closed position on the forward stroke during firing.

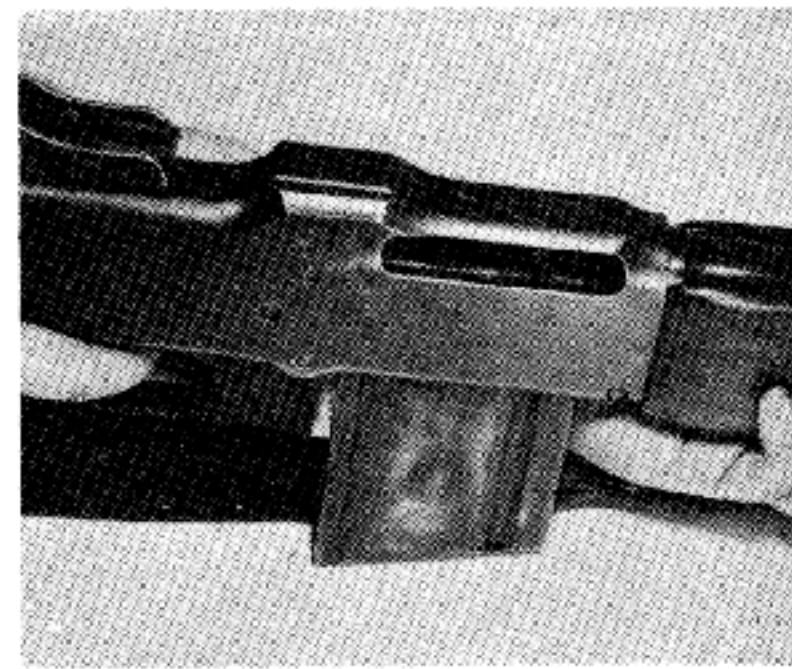

When last shot is fired, bolt stays open and trigger cannot be pulled. Pushing in the stud in the forward end of the trigger guard will release the magazine, and permit it to be withdrawn and a new magazine inserted in its place.

## FIELD STRIPPING

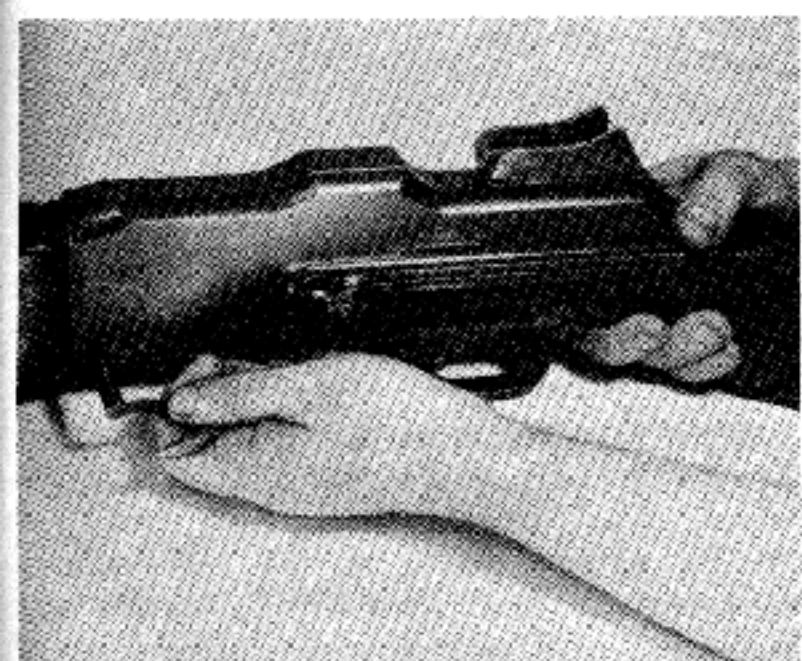

If weapon is equipped with a mount, remove it. Pull the operating handle back to cock the weapon. Then thrust it fully forward.

Rotate the gas cylinder retaining pin (at forward left end of the receiver) and withdraw it from its socket.

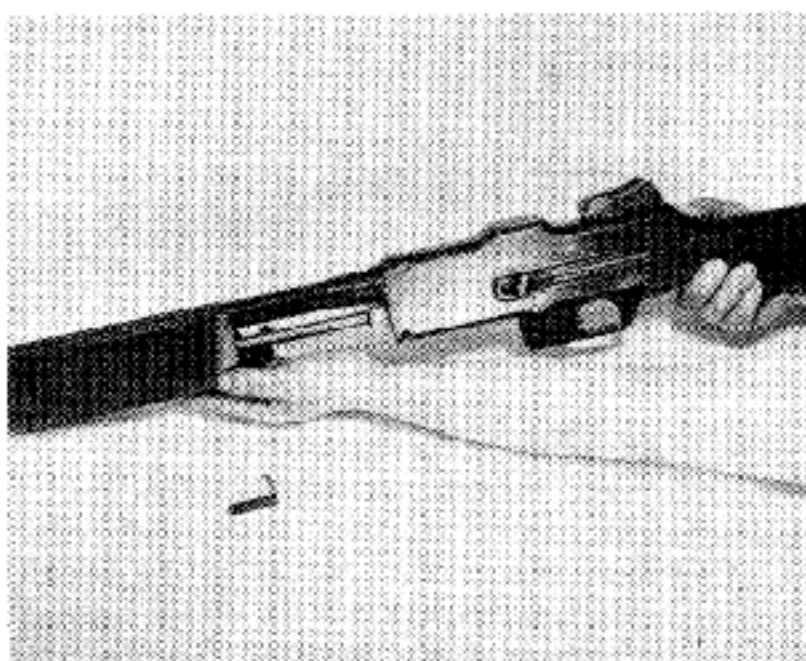

Now pull forward the forearm and gas cylinder tube and remove from the rifle. Ease the mechanism forward.

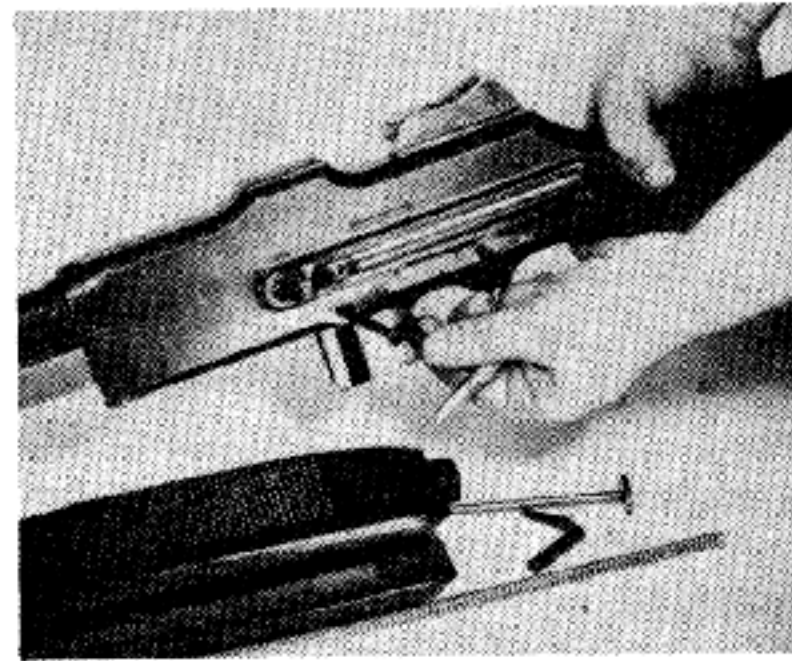

Rotate the retaining pin at forward end of trigger guard and withdraw it.



# U. S. BROWNING .30 1918 AND 1918 A1 AUTOMATIC RIFLE



The entire trigger mechanism may now be withdrawn from the bottom of the rifle.



Remove the recoil spring guide. Press in the checkered surface on its head and turn it until the ends clear the retaining shoulders; ease out the guide and the recoil spring and withdraw. Withdraw the handle by lining up the hammer pin holes on the side of the receiver and on the right side of the operating handle. Insert the point of a bullet in the hole in the operating handle with the right hand. Press back against the hammer pin while pushing the slide backward with the left hand.

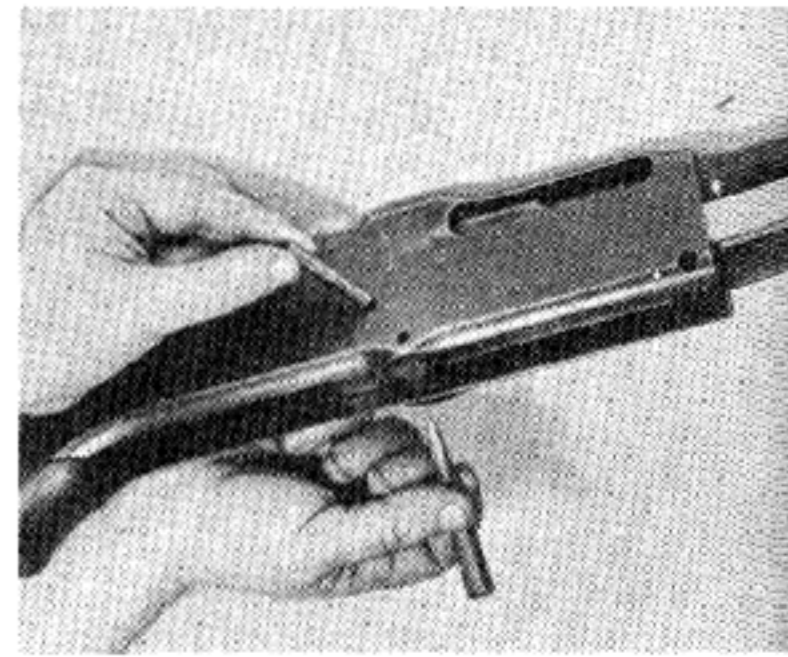

As the two holes register, the pressure of the bullet will force the hammer pin out of the large hole on the left side of the receiver and it may be withdrawn. This will permit the operating handle to be pulled straight to the rear and out of its guide.

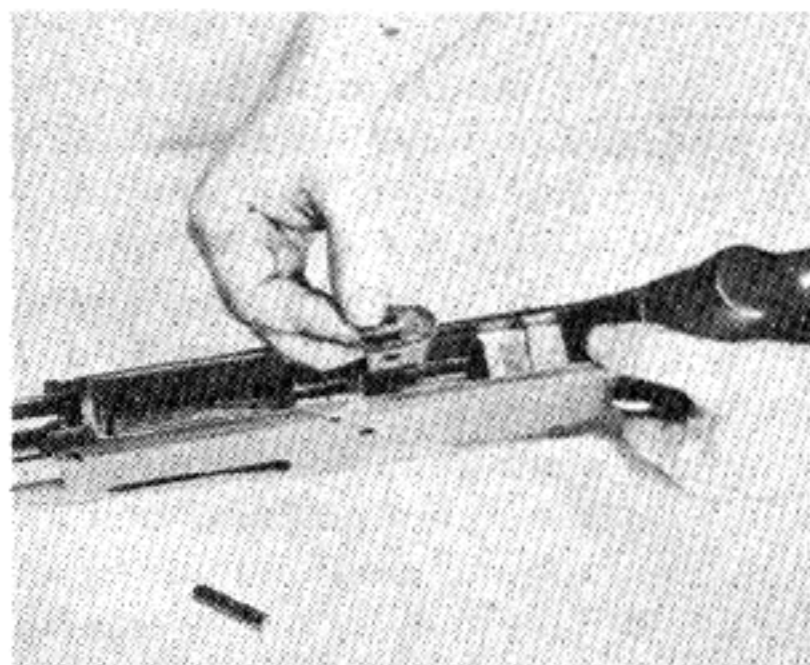

Push the hammer forward out of its seat in the slide and lift it out of the weapon.

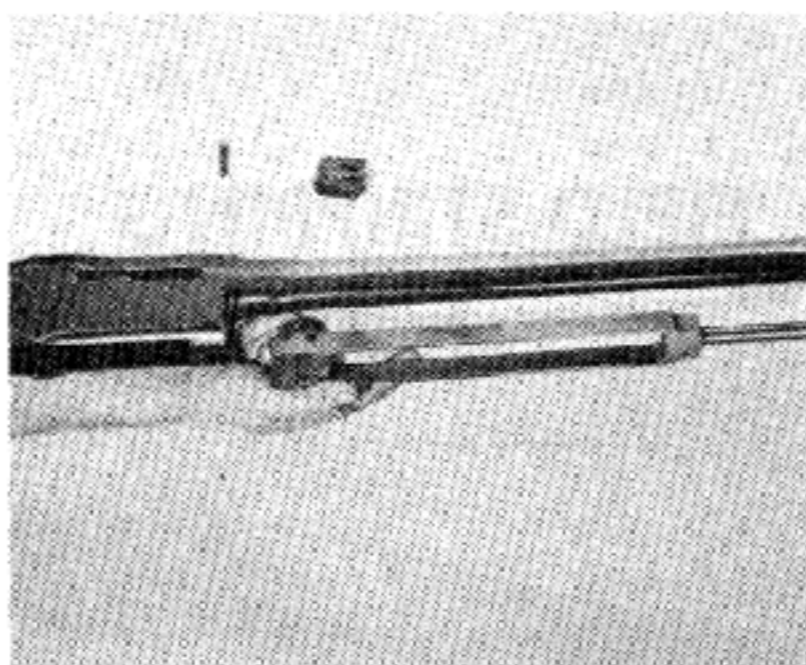

Pull the slide directly forward out of the receiver, taking care that the link is pushed well down so that slide can clear it. Remove the slide carefully to avoid striking the gas piston or its rings against the gas cylinder tube bracket female.

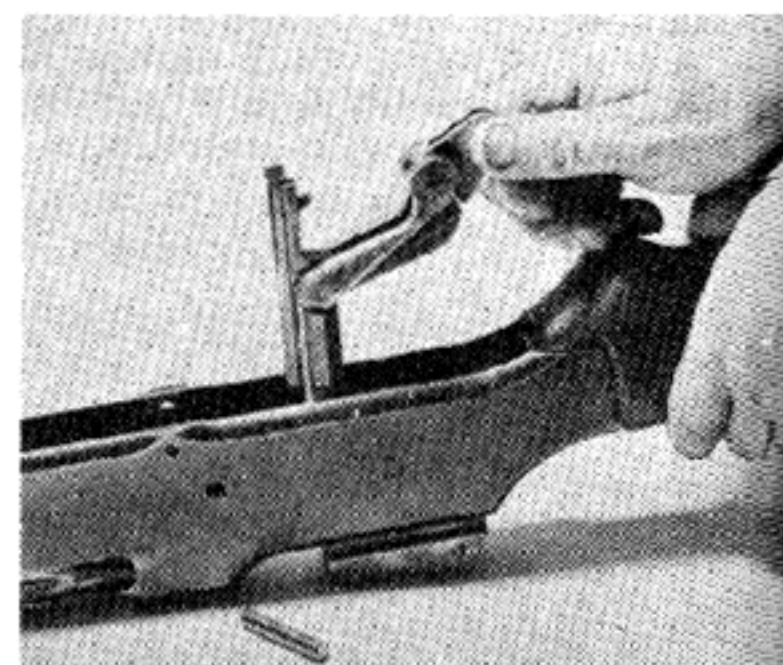

With the point of a bullet force out the spring bolt guide from inside the receiver, then lift the bolt, bolt lock and link by pulling slowly to the rear end of the receiver and then lifting them out. The firing pin may now be lifted out of the bolt and the extractor removed by pressing the small end of the cartridge against the claw and exerting upward and frontal pressure. No further stripping is normally necessary or recommended.



# U. S. BROWNING .30 1918 AND 1918 A1 AUTOMATIC RIFLE

## HOW THE BROWNING MACHINE RIFLE WORKS

Starting with the gun loaded and cocked, the action is as follows: Pressing the trigger pulls down the nose of the sear, disengaging it and permitting the slide to move forward under the action of the recoil spring. The rear end of the slide contains the hammer which is connected by a link to the bolt. The slide is pulled forward by the compressed recoil spring. During the first quarter inch of travel of the slide, the front end of its feed rib strikes the base of the top cartridge in the magazine, driving it ahead towards the firing chamber.

When the cartridge has traveled about a quarter of an inch, the bullet strikes the bullet guide on the breech and is deflected upward towards the chamber. This action also guides the front end of the cartridge from under the magazine lip. When the head of the cartridge reaches the part of the magazine where the locking lips are cut away and the opening enlarged, the magazine spring forces it out of the magazine. The base of the cartridge now slides across the face of the bolt and under the extractor; and if it fails to position correctly the extractor will still snap over its head as the bolt reaches its forward position. At the time the cartridge leaves the magazine, the bullet nose is so far in the chamber that it is guided from that point on.

When the slide is within two inches of its complete forward position, a circular cam surface on the bottom of the bolt lock starts to ride over the rear shoulders of the bolt support, camming up the rear end of the bolt lock. The link pin raises above the line joining the bolt pin and the hammer pin, so that its joint has a tendency to buckle upwards. As the attached bolt lock is now opposite its locking recess in the receiver it pivots upward about the bolt lock pin. The link whose lower edge is attached to the hammer pin revolves upward and forces the bolt lock up; the rounded surface on the bolt lock, just above this locking face, slips over the locking shoulder in the hump of the receiver and provides a lever thrust which forces the attached bolt home into final position.

The bolt lock is now above the position of the bolt, and locks firmly in the hump in the receiver as the hammer pin passes beneath the link pin. The firing pin is in the bolt, with a lug on its rear end buried in the slot at the other side of the bolt lock, making it impossible for the firing pin to be struck by the hammer at anytime except when the bolt lock is in its recesses in the hump of the receiver. Thus when the hammer pin passes under the link pin, the head of the firing pin is exposed to the center rib of the hammer; and as the slide still continues forward, the hammer drives the firing pin ahead and explodes the cartridge in the chamber.

The forward motion is now halted when the front end of the slide strikes against a shoulder at the rear end of the gas cylinder tube.

**Return Movement of the Action:** About 6" from the muzzle, a small port is bored in the bottom of the barrel. As the bullet passes over this port, a small amount of gas, still under high pressure, escapes through it and passes through similar ports in the gas cylinder tube bracket, the gas cylinder tube and the gas cylinder. The gas cylinder port is the smallest of these and acts as a throttle on the barrel pressure. The ports in the gas

cylinder lead radially into a small well situated in the head of the gas cylinder. Through this well the pressure is conducted to the gas system plug, through which it acts on the piston for the length of time the bullet is traveling the 6" distance from barrel port to muzzle. This results in a sudden, hard blow, backward against the piston plug.

The gas piston is assembled to the slide, and the sudden blow as it drives the gas piston back also forces back the slide and the parts attached to it and compresses the recoil spring which is seated in the slide.

After the piston has traveled back a little over  $\frac{1}{2}$ ", bearing rings on its rear and corresponding ones in the gas piston plug pass out of the gas cylinder. The gas now expands around the gas piston head into the gas cylinder tube where it is exhausted into six portholes in the tube placed just at the rear of the gas cylinder tube brackets.

Two rings on the piston about an  $1\frac{1}{4}$ " from the head, prevent most of the gas from traveling back through the gas cylinder tube; and also act as bearings to maintain the front end of the piston in the center of the gas cylinder tube after the piston has passed out of the cylinder.

**Unlocking Action:** As the hammer pin is slightly in advance of the connecting link pin, the initial backward movement of the slide carries the hammer back without moving either the attached bolt lock or bolt; and when the movement has progressed far enough (about  $\frac{1}{5}$ ") and the high breech pressure has dropped to safe limits, the unlocking action starts. The link is compelled to revolve forward about the hammer pin, and so to draw the bolt lock down out of a hump in the receiver and start it to the rear. The motion of the bolt and bolt lock is now accelerated as the lock is drawn completely out of its locking recess, locking the shoulders in the receiver.

As the bolt lock is prevented from revolving from below the line of backward travel of the bolt, further rearward travel of all moving parts is in a straight line. Meanwhile, however, during the unlocking motion, a cam surface on the slot in the bottom side of the bolt lock has come in contact with a cam surface on the firing pin lug, and has drawn the firing pin away from the base of the bolt.

Also during the backward action, the circular cam surface on the lower part of the bolt lock, operating on the rear shoulders of the bolt support, has produced a lever action tending to loosen the cartridge case in the firing chamber. From that point, the slide and all its moving parts are traveling to the rear at the same speed, carrying along the empty cartridge case held in its seat in the face of the bolt by the extractor (the extractor is positioned in the upper right side of the bolt near the ejection port). Thus as the slide nears the end of its travel and the base of the empty cartridge case strikes the ejector on the left side of the bolt feed rib, the empty case is pivoted about the extractor and through the ejection port. As the front end of the cartridge case passes out of the receiver, it is so pivoted that it strikes the outside of the receiver about an inch to the rear of the ejection port; and hence rebounds towards the right front.



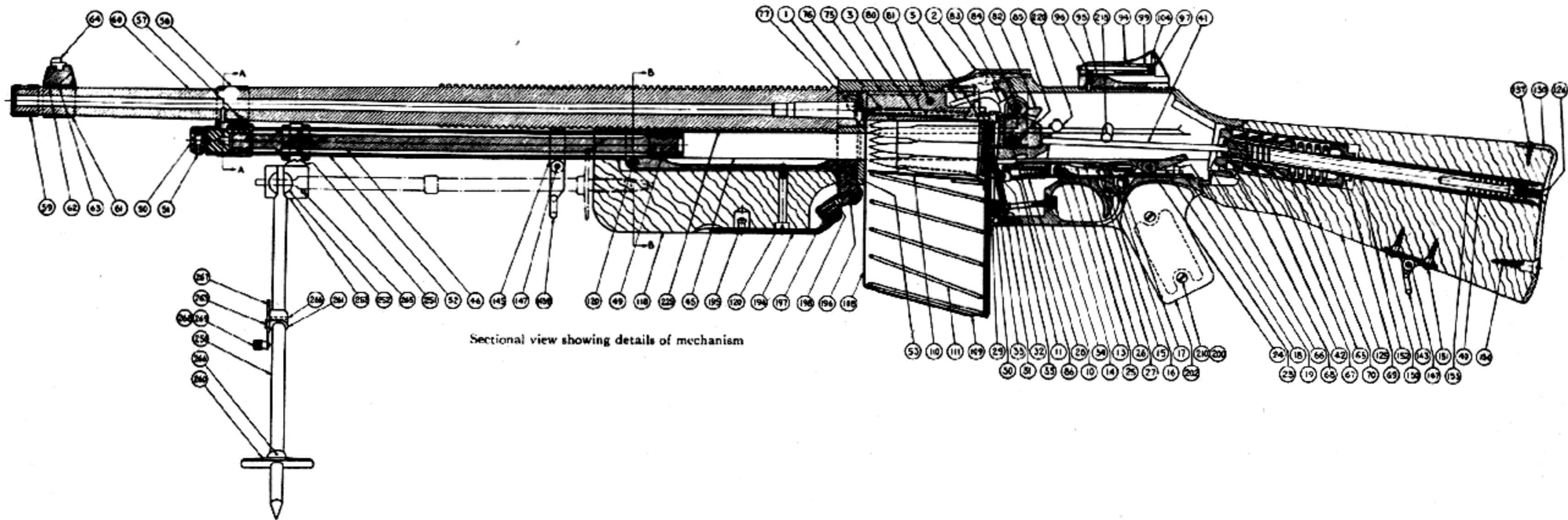

Sectional view showing details of mechanism

KEY

- |   |   |                                     |   |
|---|---|-------------------------------------|---|
| 1. Receiver.                              | 41. Recoil spring rod.                        | 80. Bolt lock.                      | 152. Recoil spring tube.                    |
| 2. Top plate.                             | 42. Recoil spring rod follower.               | 81. Bolt lock pin.                  | 153. Recoil spring tube screw.              |
| 3. Bolt support, right                    | 45. Slide.                                    | 82. Link.                           | 194. Magazine opening cover.                |
| 5. Bolt support rivet (6).                | 46. Gas piston.                               | 83. Link pin.                       | 195. Magazine opening cover knob.           |
| 10. Trigger guard, with stem for grips.   | 49. Gas piston retaining pin.                 | 84. Link pin spring.                | 196. Magazine opening cover screw.          |
| 11. Trigger guard retaining pin complete. | 50. Gas cylinder.                             | 85. Hammer.                         | 197. Magazine opening cover plunger spring. |
| 13. Trigger.                              | 51. Gas cylinder lock.                        | 86. Hammer pin.                     | 198. Magazine opening cover plunger.        |
| 14. Trigger pin.                          | 52. Gas cylinder tube.                        | 94. Rear sight base.                | 200. Grip screw bushing.                    |
| 15. Connector pin.                        | 53. Gas cylinder tube retaining pin complete. | 95. Rear sight spring.              | 202. Grip, left hand.                       |
| 16. Connector.                            | 56. Gas cylinder tube bracket.                | 96. Rear sight spring screw.        | 210. Grip screw (4).                        |
| 17. Change lever.                         | 57. Gas cylinder tube bracket pin.            | 97. Rear sight axis screw.          | 218. Ejector opening cover safety stud.     |
| 18. Change lever spring.                  | 59. Muzzle ring.                              | 99. Rear sight slide.               | 220. Ejector opening cover lock stud.       |
| 19. Sear stop.                            | 60. Barrel.                                   | 104. Rear sight leaf.               | 225. Forearm cover.                         |
| 23. Sear.                                 | 61. Front sight carrier.                      | 108. Magazine body.                 | 250. Bipod legs.                            |
| 24. Sear pin.                             | 62. Front sight carrier key.                  | 109. Magazine base.                 | 251. Bipod yoke, fixed (in 2 parts).        |
| 25. Sear carrier.                         | 63. Front sight carrier pin.                  | 110. Magazine follower.             | 252. Bipod pivot.                           |
| 26. Sear spring.                          | 64. Front sight blade.                        | 111. Magazine spring.               | 253. Bipod swivel.                          |
| 27. Connector stop.                       | 65. Buffer tube.                              | 118. Forearm (wood).                | 260. Bipod shoe.                            |
| 28. Counter recoil spring.                | 66. Buffer.                                   | 120. Forearm screw, long.           | 261. Bipod leg brace yoke, left hand.       |
| 29. Ejector.                              | 67. Buffer friction cone.                     | 125. Butt stock.                    | 263. Hook stud (2).                         |
| 30. Ejector lock.                         | 68. Buffer friction cup.                      | 136. Butt plate screw, long.        | 265. Bipod swivel pin.                      |
| 31. Ejector lock spring                   | 69. Buffer nut.                               | 143. Sling strap swivel, rear.      | 266. Bipod shoe and leg brace yoke pin (4). |
| 32. Magazine catch.                       | 70. Buffer spring.                            | 143b. Sling strap swivel, front.    | 267. Bipod hook with stop pin.              |
| 33. Magazine Catch spring.                | 75. Bolt.                                     | 145. Front swivel bracket.          | 268. Bipod hook knob.                       |
| 34. Magazine release.                     | 76. Firing pin.                               | 147. Swivel screw (2).              | 269. Bipod hook knob rivet.                 |
| 35. Magazine catch pin.                   | 77. Extractor.                                | 150. Butt swivel bracket.           |   |
| 40. Recoil spring.                        | 78. Extractor spring.                         | 151. Butt swivel bracket screw (2). |   |



# U. S. BROWNING .30 1918 AND 1918 A1 AUTOMATIC RIFLE

The rearward motion is now completed as the end of the slide strikes against the end of the buffer, and the sear nose catches in the notch at the underside of the slide and holds the weapon open and ready for the next pull of the trigger. (If the weapon is set for full automatic fire, the sear nose is held depressed, so that it does not stop the slide which continues forward, firing the weapon in the full automatic cycle.)

The buffer is a tube in the butt of the rifle in which are placed a buffer head against which the slide stops, a friction cup slit to allow for expansion, a steel cone to fit into the cup, and four more cups and cones in series. Behind these is the coil buffer spring and the buffer nut which is screwed into the end of the tube to form a seat for the spring.

As the rear end of the slide strikes the buffer head, it moves it to the rear, forcing the cups over the cone causing them to expand tightly against the tube, thus producing friction as the cups move back and the buffer spring is compressed. The rearward motion of the slide is therefore checked gradually, and practically no unpleasant rebound occurs. The friction mechanism is returned to its original place by the compression of its spring.

**Note:** A very important feature of this rifle is that the bolt, bolt lock and link mechanism start back comparatively slowly and do not attain the speed of the slide itself until after the period of high breech pressure passes. This feature is also important in that it does not subject the mechanism to undue strain as the gas pushes the piston back.

**Note:** There are three different gas ports. The

weapon will normally be set to operate on the smallest port. It is properly aligned by screwing in the gas cylinder with combination tool until the shoulder of the cylinder is one turn from the corresponding shoulder of the gas cylinder tube, and the smallest circle on the cylinder head is towards the barrel. (To permit setting the regulator, the split pin must be pushed out sufficiently to permit the regulator to be turned.)

If the rifle is sluggish from insufficient gas, the cylinder should be set one complete turn on each side of the original setting. However, it is to be noted that the larger ports are provided only for emergency use. They should be utilized only when through lack of oil or accumulation of dirt or carbon, the rifle is sluggish and conditions make it impossible to properly correct these troubles. It is therefore essential that the threads should be kept cleaned and oiled and cylinder free to turn at all times.

In field service, at the first sign of insufficient gas, unscrew the cylinder a third of a turn, and line up the medium circle and port with the gas opening.

When gas is insufficient, the weapon may fail to recoil because the port is not properly aligned or is unusually dirty. (A very dirty mechanism may also cause such a stoppage.) Or the weapon may not recoil far enough to permit complete ejection or the ejection may be weak. Under some conditions, although this is unusual, it may result in uncontrolled automatic fire.

On the other hand if the gas pressure is too high, the rifle will be speeded up too much causing a pounding which will interfere with accuracy. This may also generate excessive heat in the gas operating mechanism.

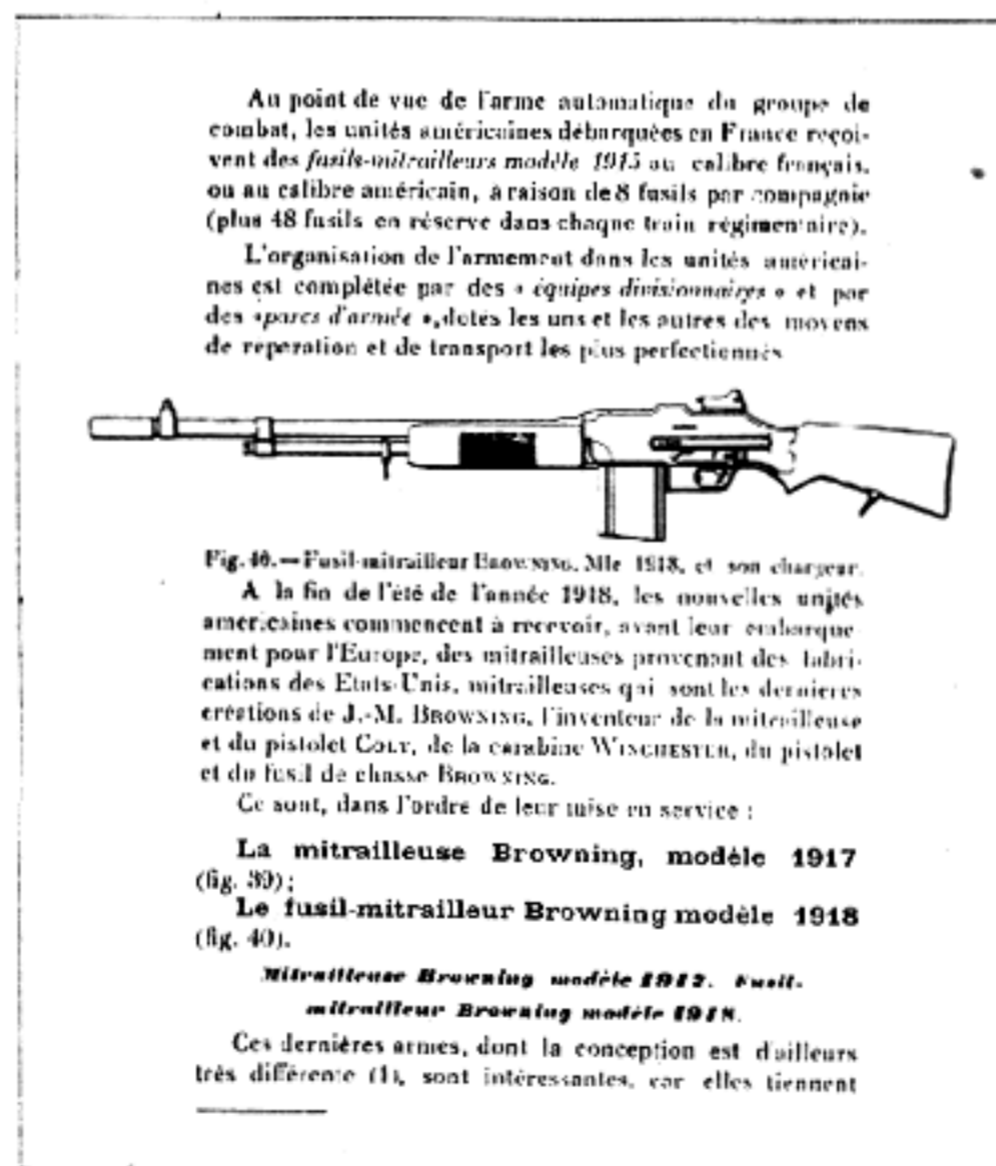

This weapon is in wide use throughout the world. It was manufactured and sold by Belgian manufacturers before the war; and large quantities were sold to the Japanese, among others. This excerpt is from a French manual on the weapon.



# U. S. BROWNING MACHINE RIFLE M1918 A2

This is a modification of the famous Browning Automatic Rifle. The change lever spring and the carrier have been modified. Several new components have been added. These include a sear release stop lever, a sear, key and head buffers, sear release actuator and actuator

spring, actuator stop and buffer head. The bipod is attached to the flash hider. A stock rest has been added and the forearm made lighter. A trap plate has been added between the barrel and the gas cylinder tube.

## HOW THE GUN WORKS

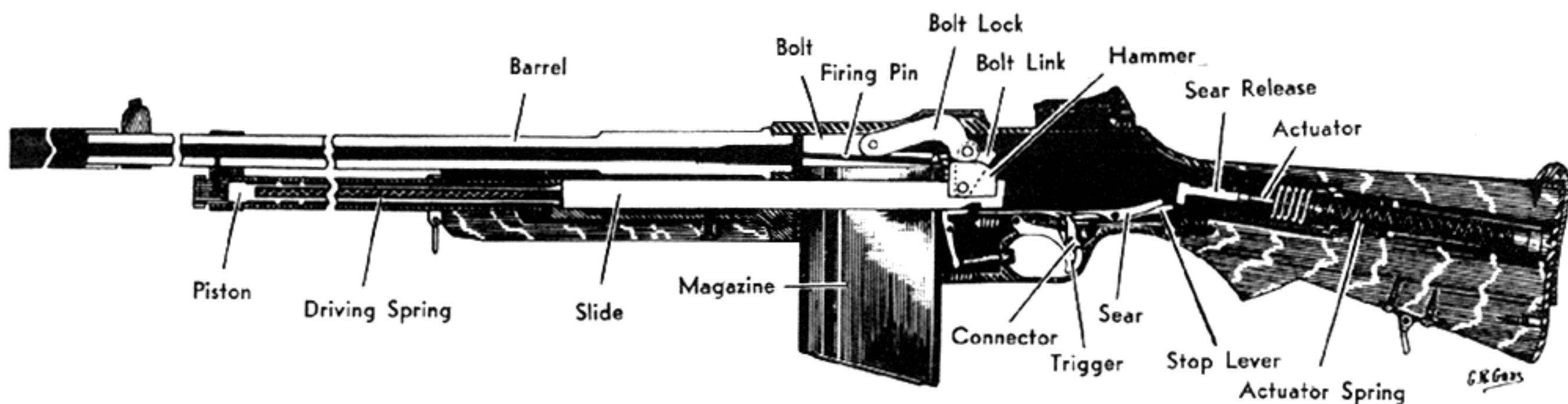

This gun has been modified to replace the single shot mechanism. Single shots can be fired in this modified version **only** by pressing and releasing the trigger rapidly.

However, as a compensating factor, the gun has been designed to fire at a low and a high rate of speed somewhat in the manner of the French Chatelleraut and the British Besa Machine Guns.

Setting the changer lever at "S" renders the gun safe as in earlier models. Setting the change lever at "A" permits full automatic fire at the regular rate as in the earlier models.

Setting the change lever at "F", however, brings into play a rate-reducing mechanism which slows the rifle down to a rate of about 340 shots per minute.

When the change lever is at "F", the rifle is cocked in normal fashion and the sear engages in a notch in the slide. Pressing the trigger in the usual manner results in controlled automatic fire at a reduced rate which will be delivered as long as the trigger is held back. There is a distinct difference noticeable when handling the gun when the mechanism is in operation and when it is firing full automatic without it. There is **no provision made** for semi-automatic fire in this model.

On pressing the trigger the slide goes forward in normal B.A.R. fashion firing the cartridge, then the slide starts on its rearward movement in the usual manner driven back by gas expanding into the gas cylinder, but it picks up the sear release and strikes it on the front

end. This forces the sear release to the rear until the slide reaches the face of the buffer head; while during this movement it also meets the front end of the actuator. The actuator tube is forced to the rear, meeting the actuator stop. At this point the actuator **reverses its direction of travel** moving forward under the tension of the actuator spring and the slide engages on the sear. The slide remains in engagement with the sear until the actuator reaches its extreme forward position. At that point the actuator forces the sear release forward forcing it to move through the buffer head, while the foot of the sear release is in contact with the angle surface of the rear of the sear. This cams the sear out of engagement with the slide forcing the slide to go forward at this point to fire the cartridge.

The result of this action is to fire the gun full automatic **but with a distinct halt between shots**. This characteristic has been particularly valuable in jungle warfare, where the B.A.R. has more than proven its worth. While the regular full automatic rate is of value for burst firing or against low flying planes, its normal rate is too high for ordinary land operation without wasting ammunition. Under the new system, the B.A.R. with its powerful .30 cartridge provides an ideal weapon for firing in forests and jungles where greater penetration than is normal in the submachine bullet is desirable; and where targets are not always visible and hence are not susceptible to individual aimed shots.



# U. S. WINCHESTER .30 M1 CARBINE



**Magazine:** Box type, detachable, capacity 15 rounds. Positioned directly under receiver.  
**Muzzle Velocity:** About 2,000 feet per second.  
**Weight of Bullet:** 110 grains, lead with metal jacket.  
**Striking Energy:** About 900 foot-pounds.  
**Barrel Length:** 18".  
**Overall Length of Carbine:** 35½".  
**Weight:** About 5 lbs., 12 oz.  
**Sights:** Blade front protected by wings; L-type rear with apertures, set for 100 and 300 yards.  
**Accurate Range:** About 300 yards.  
**Maximum Range:** About 2,000 yards.  
**Carbine Operated By:** Gas. As bullet passes a small

hole in the barrel, gas is drawn into a gas cylinder below the barrel. This expands and drives back a piston which operates the action.

**Locked:** By rotating bolt as in Garand rifle.

**Type of Fire:** Single shot only. Pressing the trigger fires the cartridge, ejects the empty case, loads in a new cartridge and leaves the weapon cocked and ready for next pull of trigger.

**Magazine Release Catch:** Button on right side to rear of magazine housing.

**Position of Bolt When Last Shot is Fired:** Closed.

**Safety:** On right side of trigger guard.

## LOADING AND FIRING

Load magazine exactly as for automatic pistol with 15 cartridges.

Thrust up into position in the magazine housing until it locks.

Pull back handle of operating slide on right side of gun as far as it will go, opening the action and allowing a cartridge to rise in the magazine in line with the bolt, and cocking the weapon and compressing the return spring.

Remove hand and permit operating slide to go forward, loading the firing chamber. With heel of hand push operating rod handle forward to be sure it is fully locked. The weapon is now ready to fire.

Push the button safety in the front end of the trigger guard all the way through to the right. This is the safe position. Pushing the button through from the left hand side as far as it will go release the safety.

## HOW THE CARBINE WORKS

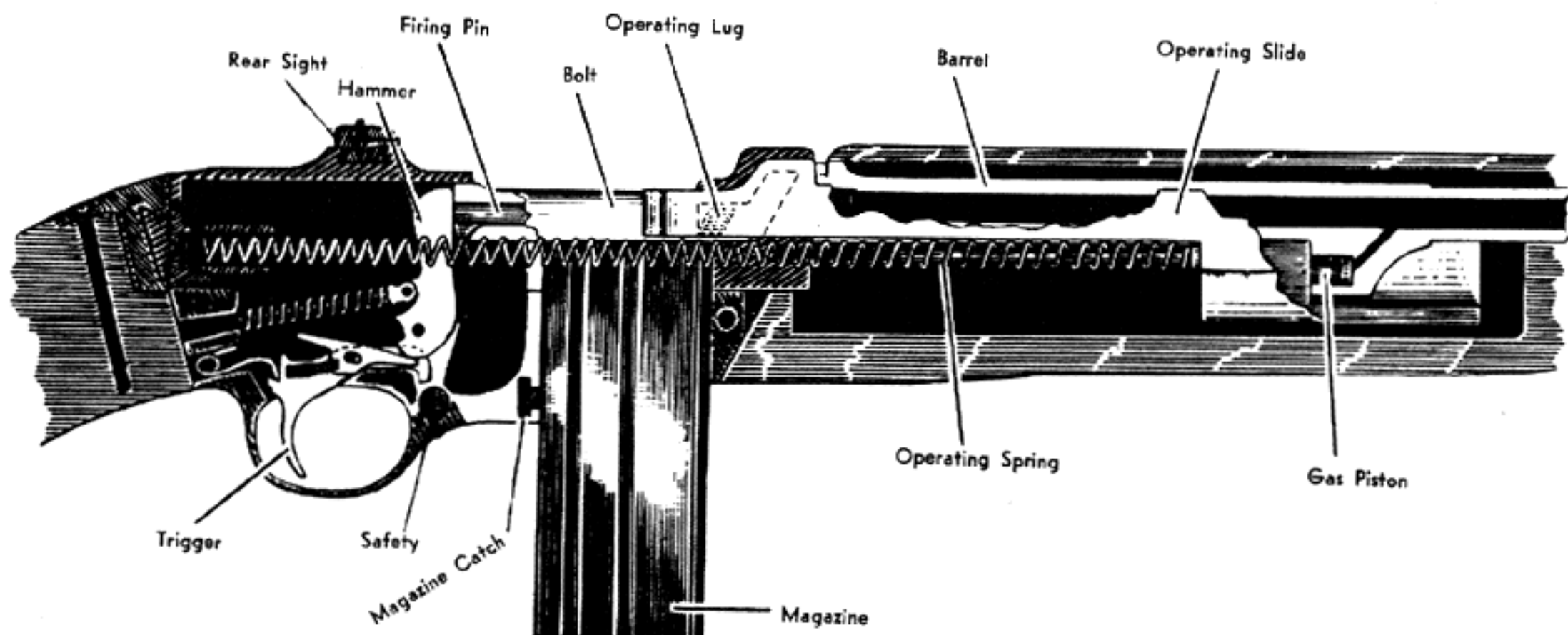



# U. S. WINCHESTER .30 M1 CARBINE

Starting with the gun loaded and cocked, the action is as follows: The trigger being pressed, the hammer is released to strike the firing pin and discharge the cartridge. As the bullet passes down the barrel, a minute quantity of gas behind it flows down through a very fine hole bored in the under side of the barrel and escapes into a sealed cylinder where it expands against the head of the piston-like operating slide. This operating slide moves back a short distance until a cam recess engages an operating lug on the bolt. During this time the bullet has had sufficient time to leave the barrel and it is safe for the action to open. The extractor fastened in the bolt draws the empty cartridge back to strike the spring-actuated ejector which hurls it out to the right front of the weapon. The bolt is rotated out of its locking recess, simultaneously turning the hammer away from the rear of the firing pin and

forcing the firing pin point to draw back inside the bolt. This compresses the hammer spring. The rearward motion of operating slide is completed when rear end of its inertia block strikes against forward end of receiver. Bolt stops when it reaches the end of bolt hole in rear receiver. Boltway is now clear permitting the next round to rise in the magazine in line with the bolt. During this motion the powerful operating slide spring has been compressed. It now drives the bolt forward loading the chamber. The cam recess in the operating slide again comes into play. Pressing against the bolt operating lug, it rotates it from left to right into its locking recess.

Forward movement of operating slide continues until the rear of its inertia block lodges against the piston in the cylinder. This action continues each time the trigger is squeezed until the last cartridge has been fired.

## FIELD STRIPPING



Push the magazine catch to the left (it is positioned just in front of the trigger guard on the right side), and withdraw magazine from below.

Draw back bolt to examine chamber and make sure that the weapon is unloaded.



At the end of the wooden fore end is a sling swivel. Push this back against the fore end and loosen it from the end by unscrewing the front band screw. A cartridge may be used as a screwdriver.

Press the front end of the lock spring towards the rear and slip the front band forward over its locking spring; it will not slip off the barrel unless the front sight is removed.

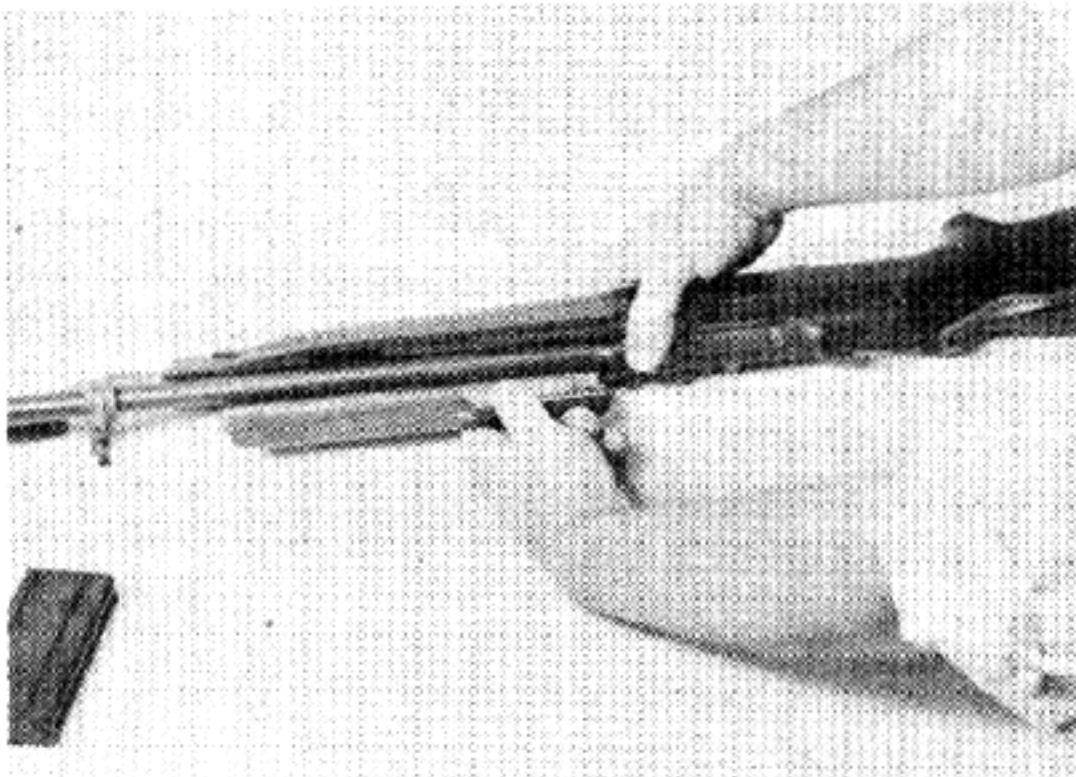

Now slide the wooden hand guard on top of the barrel forward until its liner disengages from the undercut in the forward face of the receiver; it can then be lifted from the barrel.

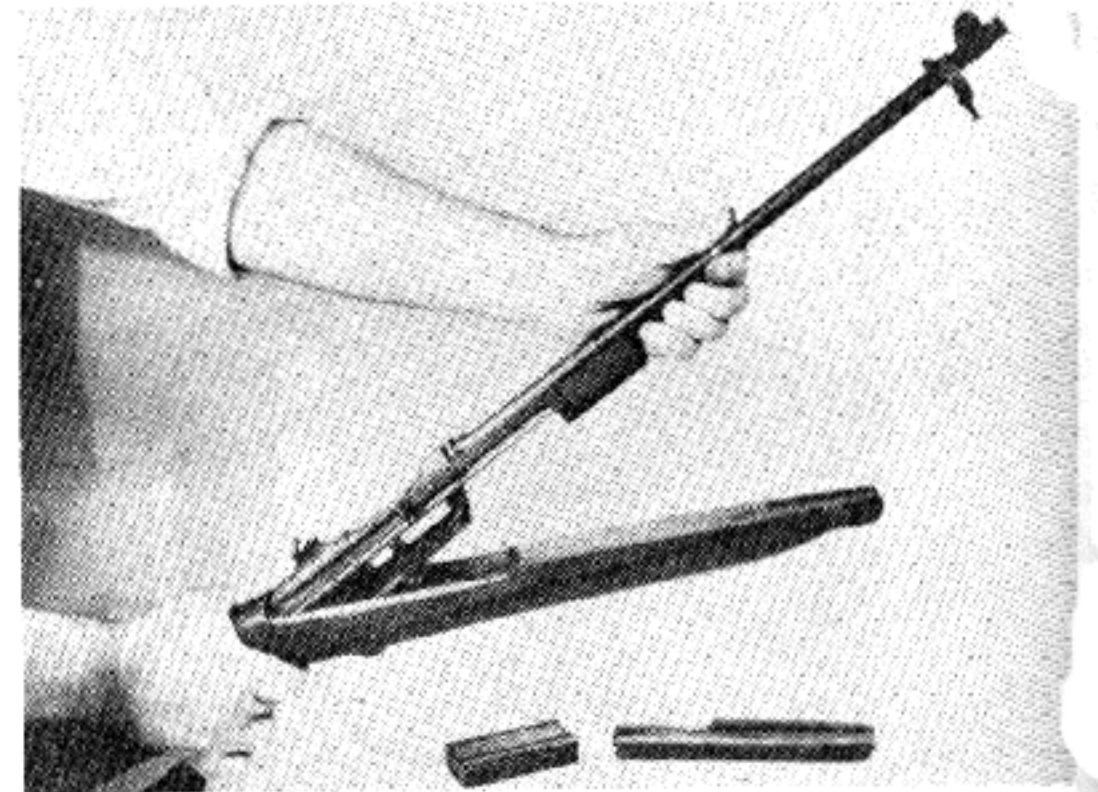

Holding the stock firmly with the right hand, grasp the barrel near the front end with the left hand and raise it until the lug at the rear of the receiver clears the retaining notch on the face of the recoil plate (the plate just above the pistol grip). The barrel and receiver can now be pulled forward and lifted out of the stock; carrying the trigger housing grip with them.



# U. S. WINCHESTER .30 M1 CARBINE

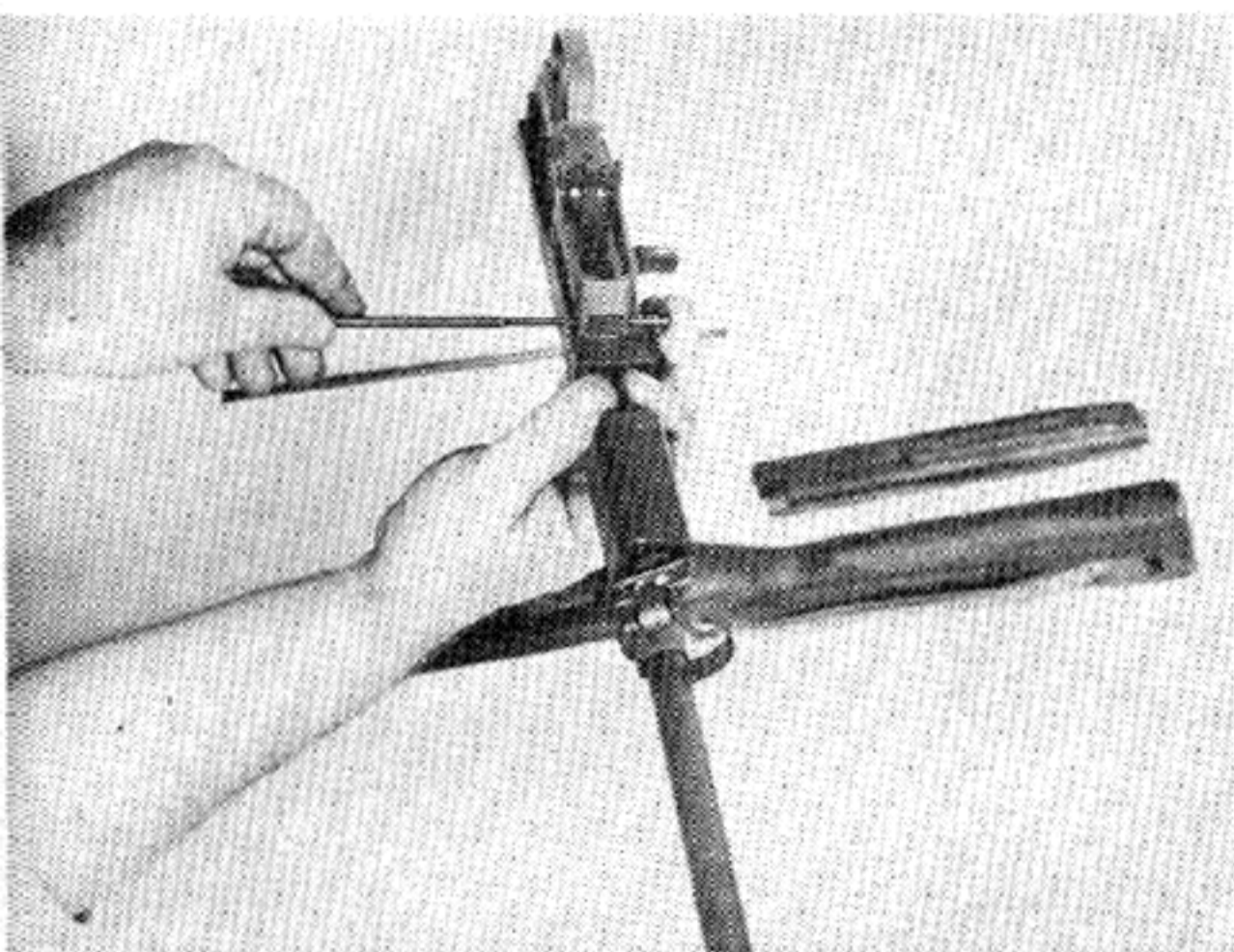

At forward end of trigger guard is the trigger housing retaining pin. Push it out from the left side until it clears the lug in the receiver.

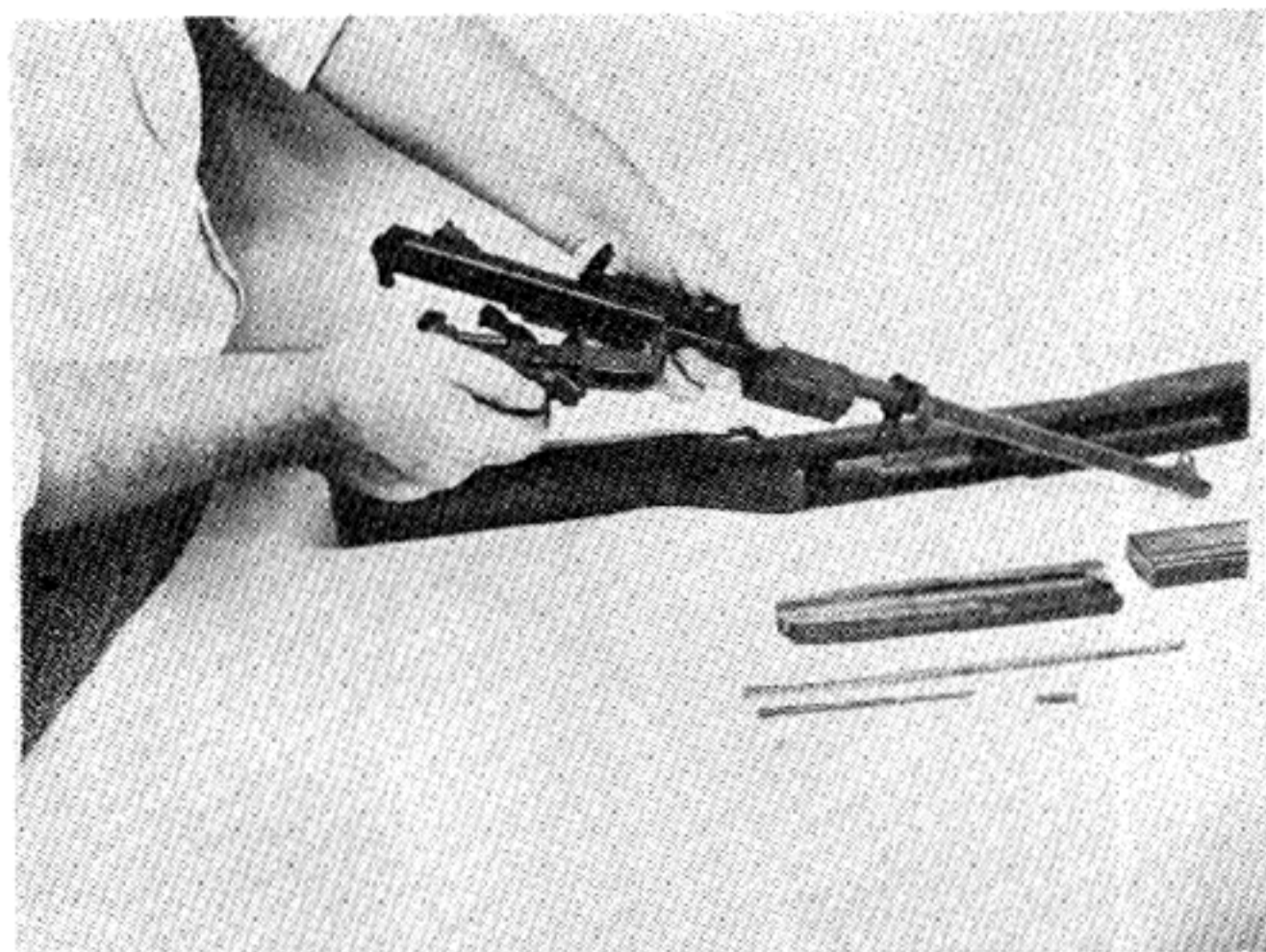

Pull the housing forward until it clears the grooves in the receiver, when it may be lifted out.

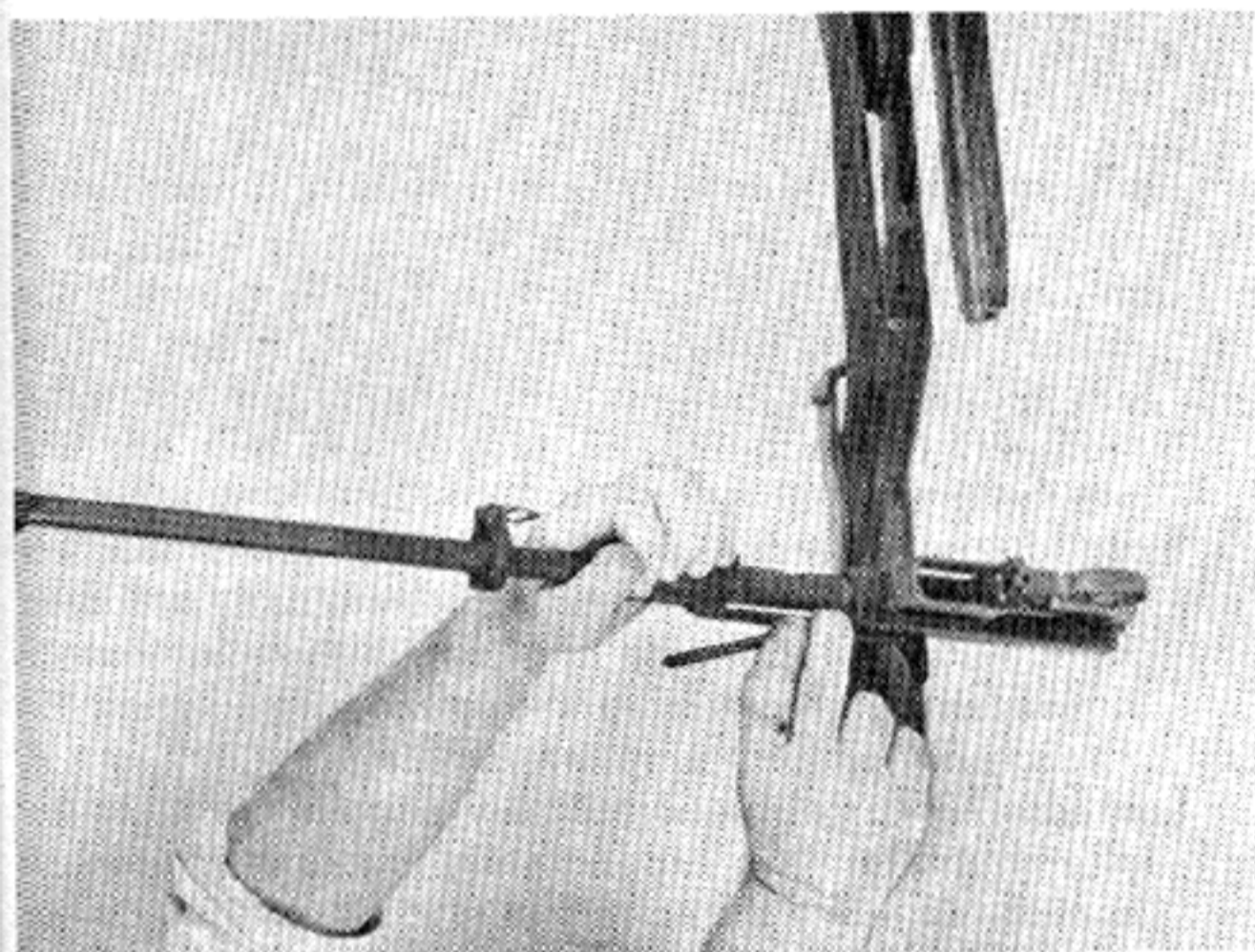

Pull back the operating slide spring guide a short distance until it is free of the operating slide. Pulling it forward and to the right permits it and its spring to be withdrawn.



Pull the operating slide back until the forward face of the stop lines up with the forward face of the top of the receiver. Lift the handle up and to the right until the guide lug clears the retaining groove of the receiver. Then push the body of the slide forward until the rear face of the stop lines up with the forward face of the top of the receiver. Rotating the slide body from right to left will now free the lug from the guideway in the barrel and permit lifting the slide out of the barrel.

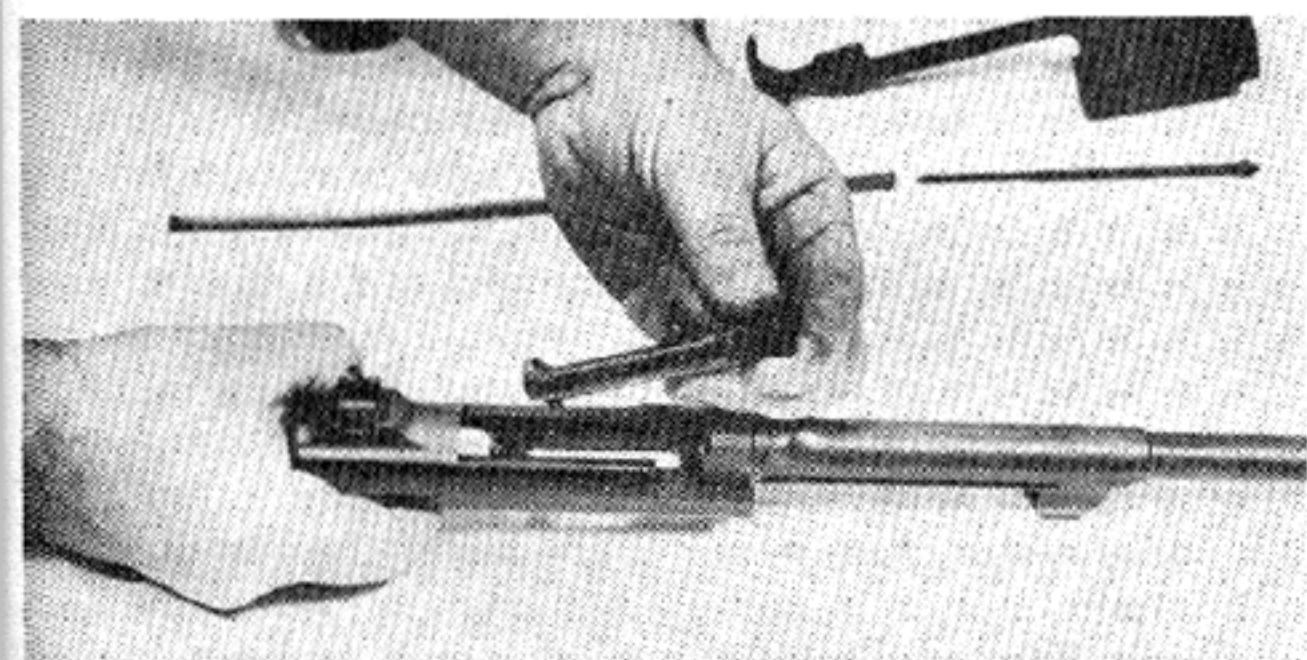

Take hold of the bolt and slide it to the rear until its face is behind the locking shoulder in the receiver. Twist the bolt from right to left, lift it to an angle of 45° and turn it bottom up. It may now be drawn forward and up out of the receiver.

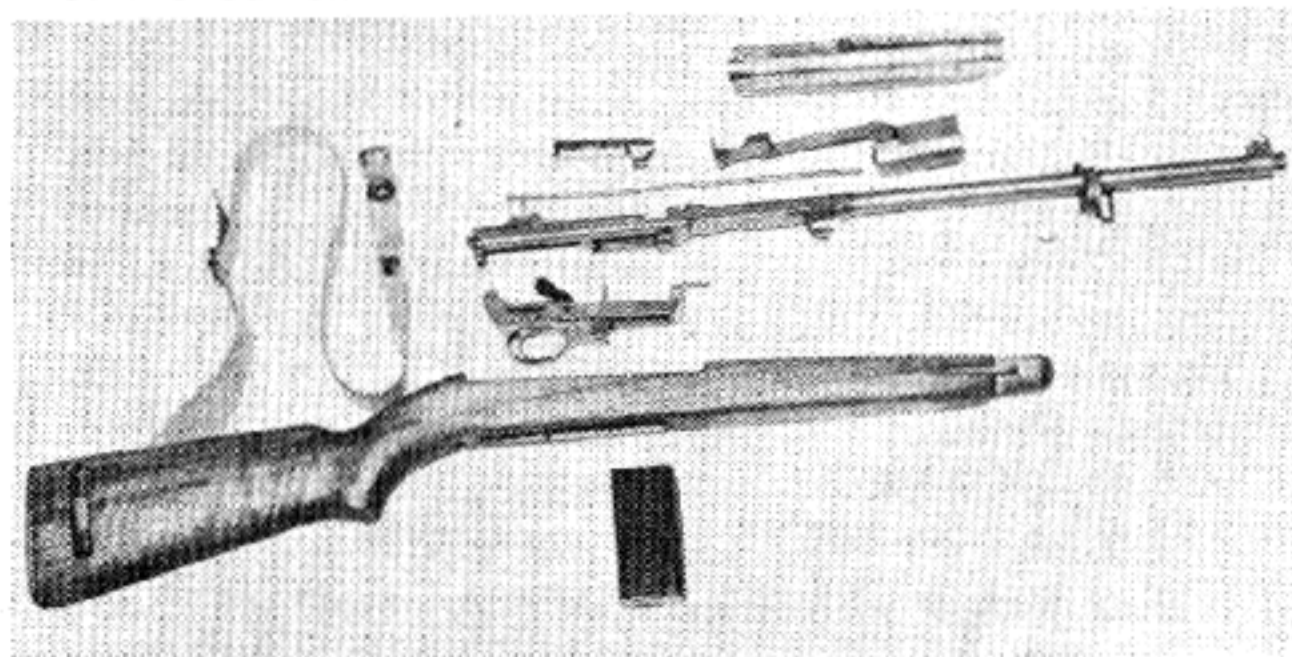

This completes Field stripping. To assemble, reverse the procedure.



# U. S. BROWNING .30 1917 AND 1917 A1 MACHINE GUN

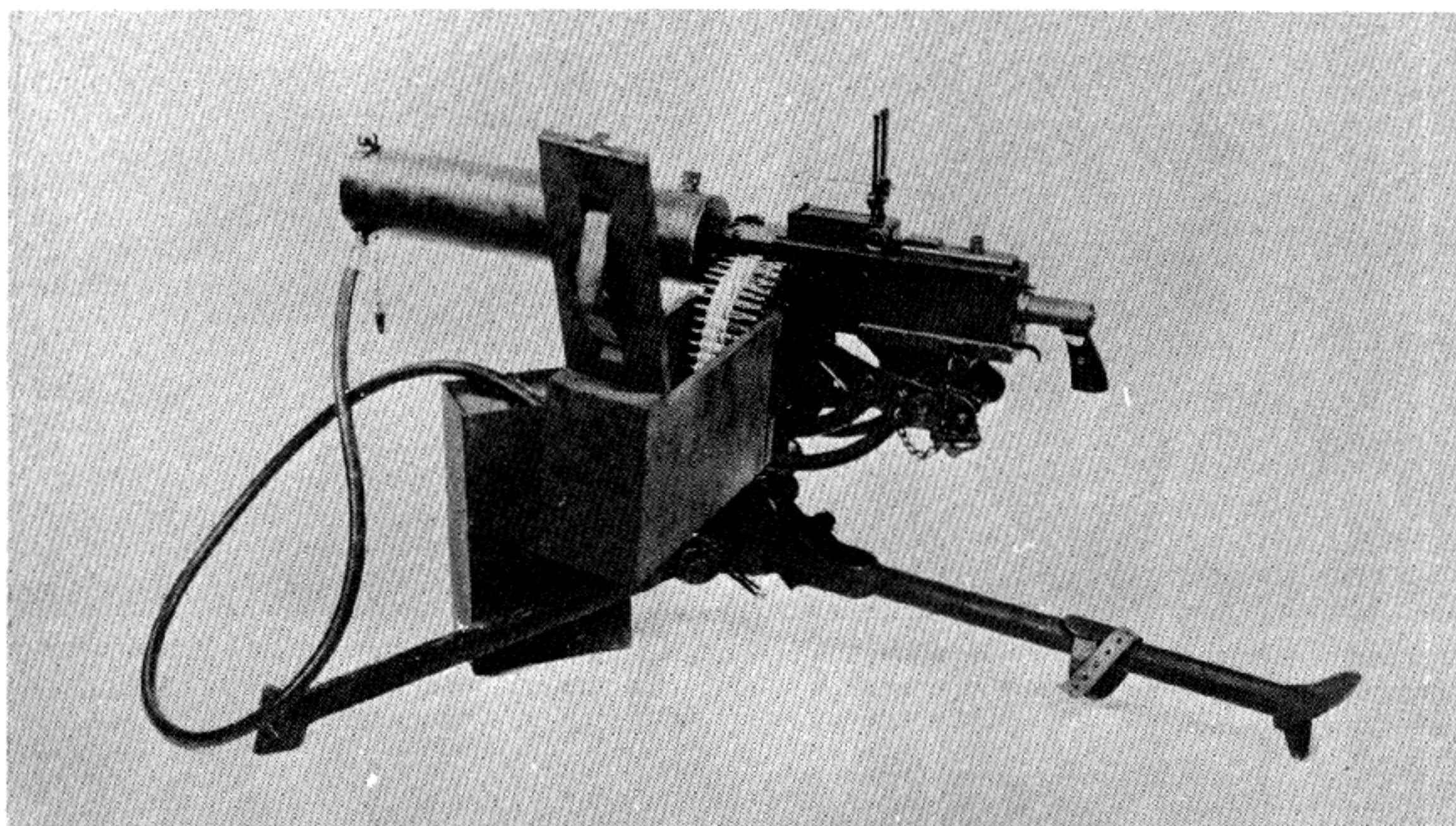

This is the famous Browning Water Cooled Machine Gun, the standard United States machine gun in its class. It is also very widely used throughout the world, having been manufactured and sold by the Fabrique Nationale de Guerre at Herstal, Belgium. This is the plant that controlled the Browning patents for sale in Europe. Incidentally both the Chinese and the Japanese have imitated and manufactured the Browning gun.

**Caliber:** .30 M1 or M2 Ammunition.

**Method of Feed:** Fabric belt holding 250 cartridges.

**Direction of Feed:** From left side of gun through to right.

**Muzzle Velocity:** M2 Ammunition, 2800 feet per second.

**Weight of Bullet:** 150 Grains. Full Jacketed.

**Barrel Length:** 24"

**Overall Length of Gun:** About 38"

**Weight of Gun and Pintle:** 33½ lbs.

**Capacity of Water Jacket:** 7 pints; adding about 7¼ lbs. to the weight of the Gun and Pintle.

**Weight of Tripod Mounting:** M-1917, 52⅓ lbs.

**Model 1917-A1,** weight 51 pounds.

**Weight of Loaded Belt and Carrying Chest:** 19 lbs. belt and ammunition alone about 14 lbs.

**Front Sight:** Blade type with cover mounted near the muzzle.

**Rear Sight:** Adjustable leaf sight with apertures and open U sights. Has windage screw to adjust in mils and provide a deflection from zero to 20 right or left. Also fitted with an adjustment for drift as in the Springfield rifle sight. If gun is sighted for M-1 ammunition, the graduations will be from zero to 3400 yards. If for M-2 or .06 ammunition, it will be from zero to 2600 yards. On weapons for European use it may be from zero to 2800 meters.

**Effective Range with Tripod, M1 Ammunition;** About 2500 yards.

**Maximum Usable Range:** M1 ammunition, several guns firing in battery, about 4,000 yards.

**Gun Operated by:** Short recoil. As the powder gas drives the bullet down the barrel, that portion of the gas thrusting back against the base of the cartridge transmits the recoil to the face of the bolt and the moving parts.

**Barrel, Barrel Extension and Bolt:** Recoil locked together about 5/8". The bolt is then automatically unlocked from the barrel extension and continues to the rear independently, compressing the driving rod spring, to furnish energy for the return motion.

**Locked:** The barrel recoil not only unlocks the bolt, but also operates the accelerating mechanism which speeds the bolt further to the rear against the action of the driving spring.

**Locked:** By a solid steel block capable of moving vertically, fitted with a projecting guide pin, which when the bolt has rejoined the barrel in forward movement, is brought in contact with and rides up on a locking cam on the bottom plate. This steel block engages rigidly behind the shoulder in the bottom of the bolt, locking it against the face of the barrel extension.

**Cooled:** By water in jacket absorbing heat. In the top of the water jacket are steam escape tubes: a fixed inner tube with a hole in each end and a shorter outer tube which slides on the inner. When gun is depressed, this sliding tube closes the forward hole and the steam escapes from the rear and vice versa. A rubber hose runs from its outlet on the water jacket to a water chest where it condenses the steam to use again.

**Cyclic Rate of Fire:** 400 to 520 rounds per minute.

**Type of Fire:** Full automatic only. It is possible by tapping trigger expertly to fire one or two shots, but in general any fire except full automatic can be achieved only by system of belt loading.



# U. S. BROWNING .30 1917 AND 1917 A1 MACHINE GUN

## LOADING

Check the following: Tripod to see that there is no unusual play; that it is firmly seated, that all its jamming handles are tight, and that the splayed feet of the legs stamp securely into the ground. Check the water jacket and condenser. Make sure that both are full. Then check to see there is no water leakage at the muzzle glands. See that rear barrel packing is water tight and oil or grease it heavily if it is not. Check head space adjustment; remember that this is a most important adjustment on this gun; if it is too tight the gun will refuse to fire; while too loose head space will result in bulged or ruptured cartridge cases which will

jam the gun badly. Check that ammunition belts are loaded uniformly and correctly and that they are clean and dry. Check rear sight for vision and working order. See that all moving parts are lightly oiled and work smoothly by drawing the bolt handle back and permitting it to go forward. All mechanism should work smoothly and no unusual effort be required to withdraw barrel and recoiling mechanism to the rear. When bolt handle is released it should position in its fully forward place and bolt should lock home properly. Bore should be inspected to be sure that it is clean.

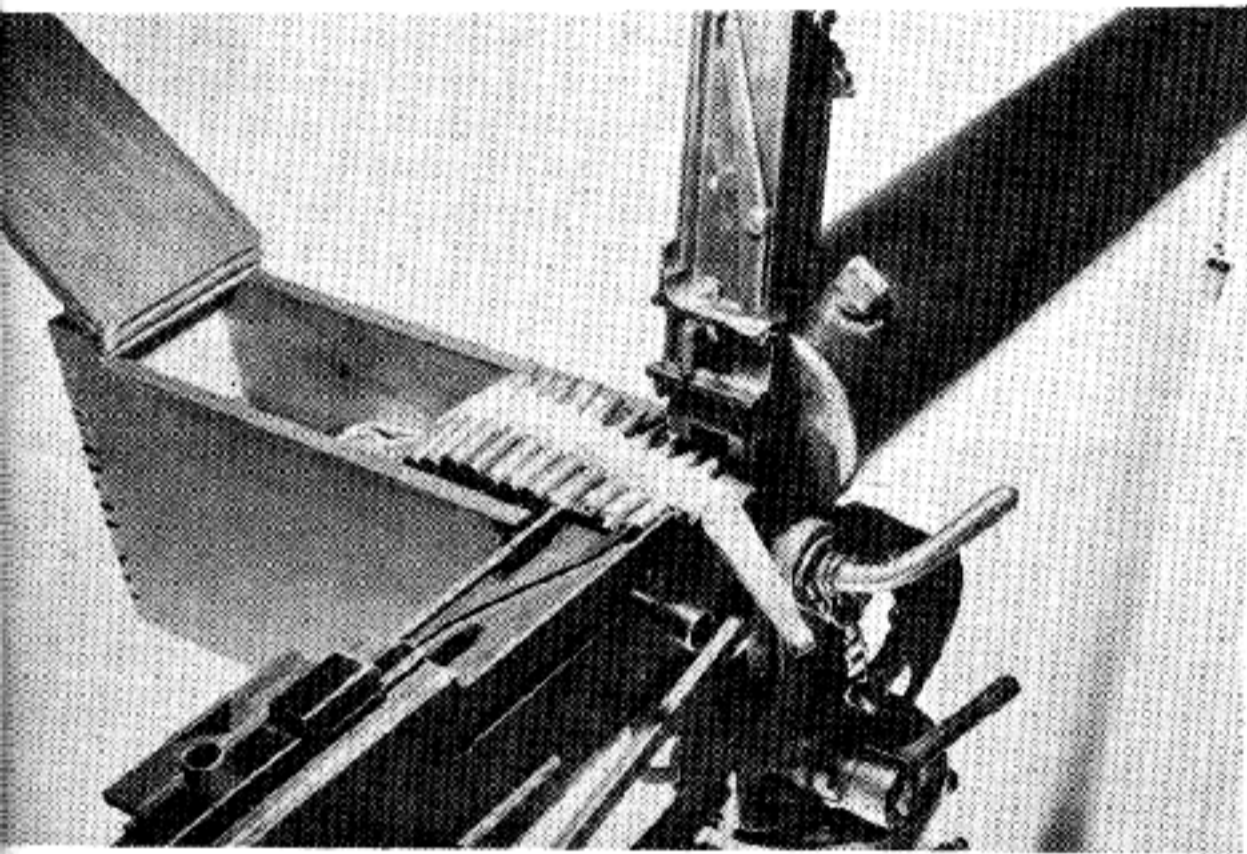

With ammunition box securely locked in place on the left side of the gun, insert the tag of the belt through the feed block as far as it will go to the right and **pull the belt sharply.**

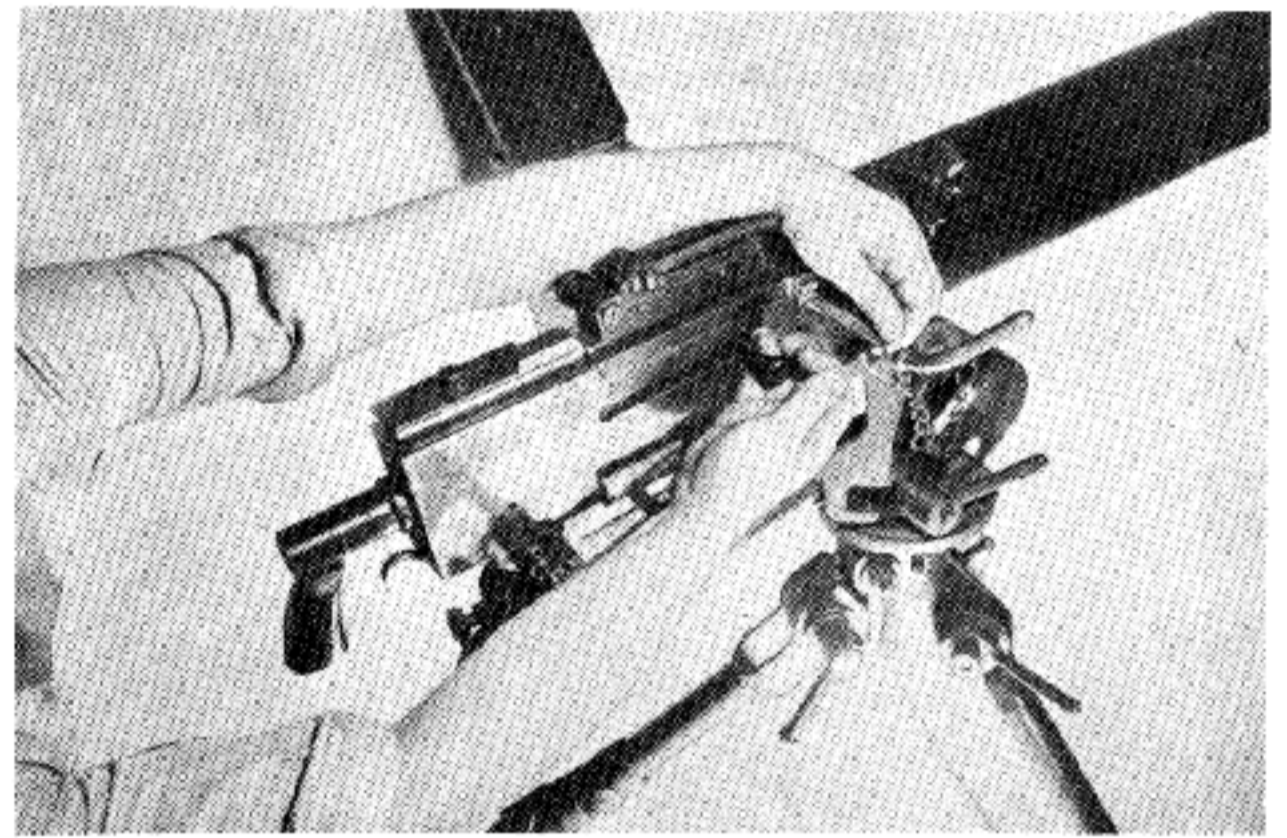

Pull the bolt handle to the rear as far as it will go. This will compress the barrel plunger spring and the driving rod spring, and when the bolt handle is released, these two springs will drive the action forward, moving the recoiling parts to their forward locked position, and **half load** the gun.

Now pull the bolt handle back **a second time** as far as it will go. Release it and let it fly forward. This completes the loading, leaving a cartridge properly positioned in the firing chamber and the weapon cocked and ready for firing.

## UNLOADING

Pull back the cover latch (this is the milled knob on top of the receiver to the rear of the rear sight). The spring controlled section will move backwards and permit you to raise the feed cover.

Lift the belt out to the left and replace it in its box.

Pull the bolt handle to the rear and look inside the bolt way to make sure there is no cartridge in the firing chamber or in the face of the breech block.

Now **push the extractor down** to its seat in the front of the breech block and let go of the cocking handle, permitting the breech block to go forward.

Snap down the cover and press the trigger.

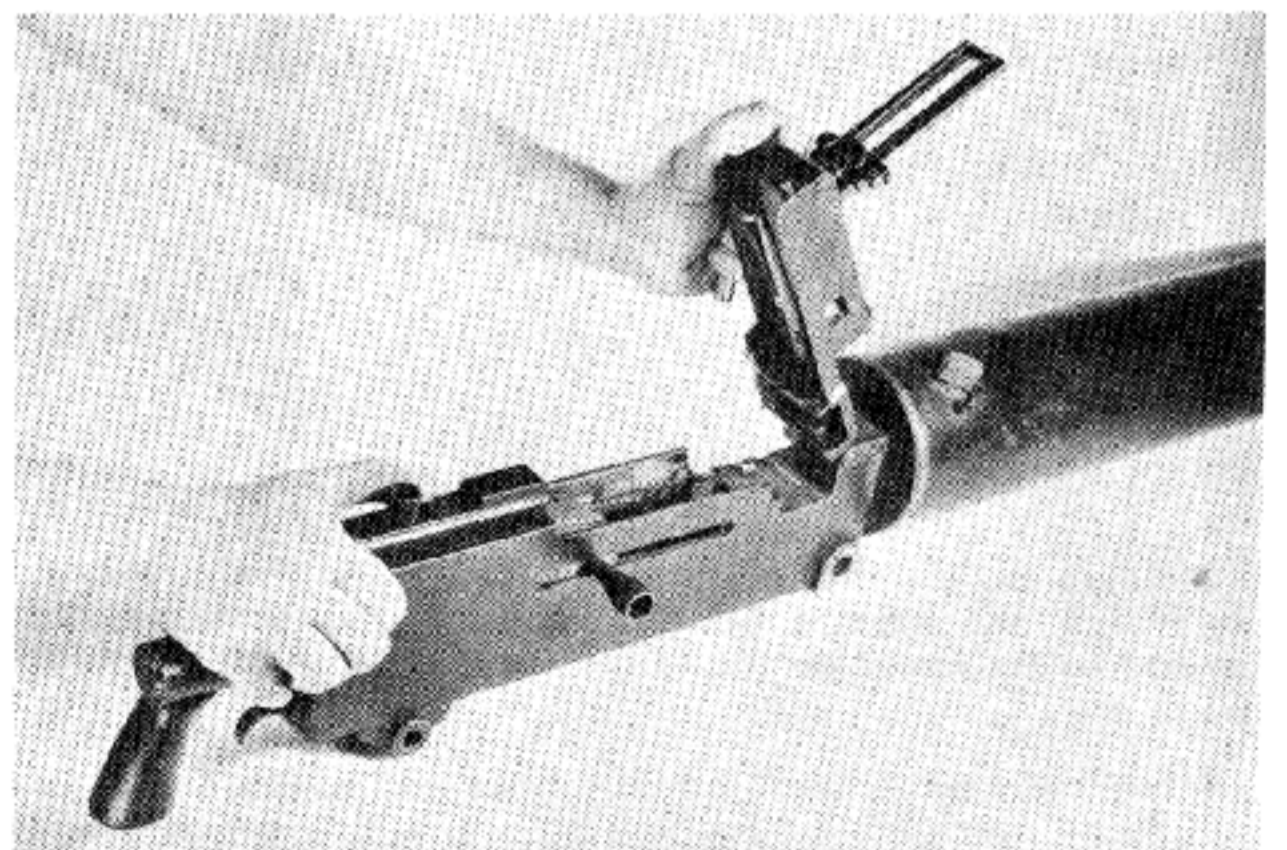



# U. S. BROWNING .30 1917 AND 1917 A1 MACHINE GUN

## STRIPPING

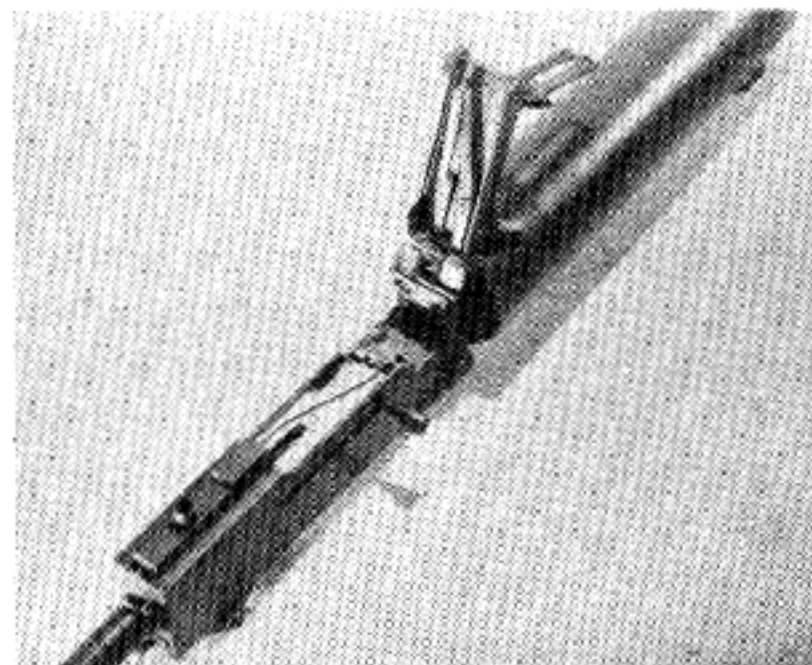

1. Raise the rear sight. Pull back the cover latch (the knob on top of the receiver behind the rear sight base) while holding it back against spring catch and raise the cover.

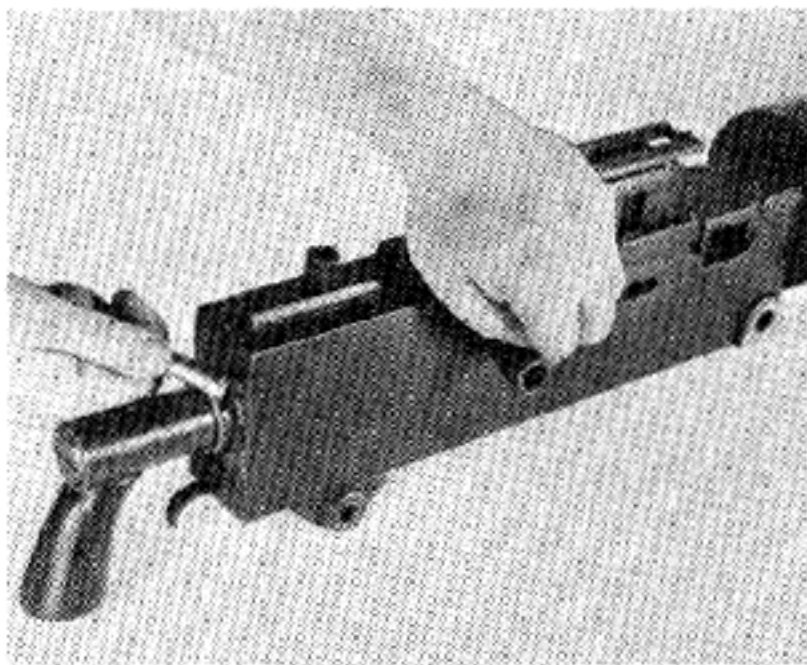

2. Draw bolt handle back as far as it will go and hold it firmly with the left hand. The driving spring rod protrudes through the back plate of the gun. Insert the base of a cartridge in the slot in the head of the rod. Push the rod in to compress the spring, and turn the rod to the right. This will lock the driving rod and its spring under compression inside the bolt.

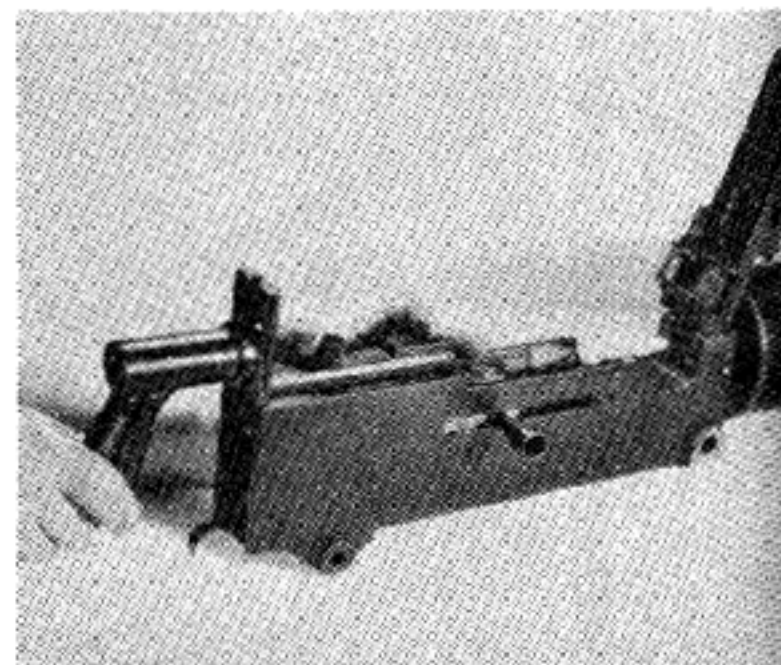

3. Push the bolt handle forward a few inches to draw the driving rod out of the locking hole in the back plate. Then pushing the cover latch forward with the left thumb, raise the pistol grip up and out of its retaining slots in the rear of the receiver.

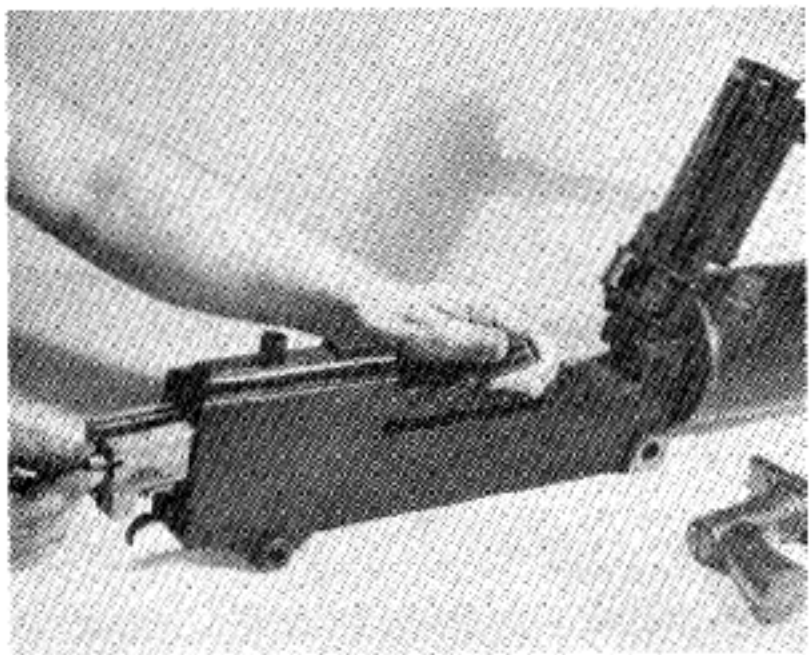

4. Pull the bolt handle as far as it will go to the rear, at which point it may be pulled to the right out of the bolt and receiver. Reach inside the receiver and grasp the driving rod; then pull the bolt directly to the rear and out of the receiver.

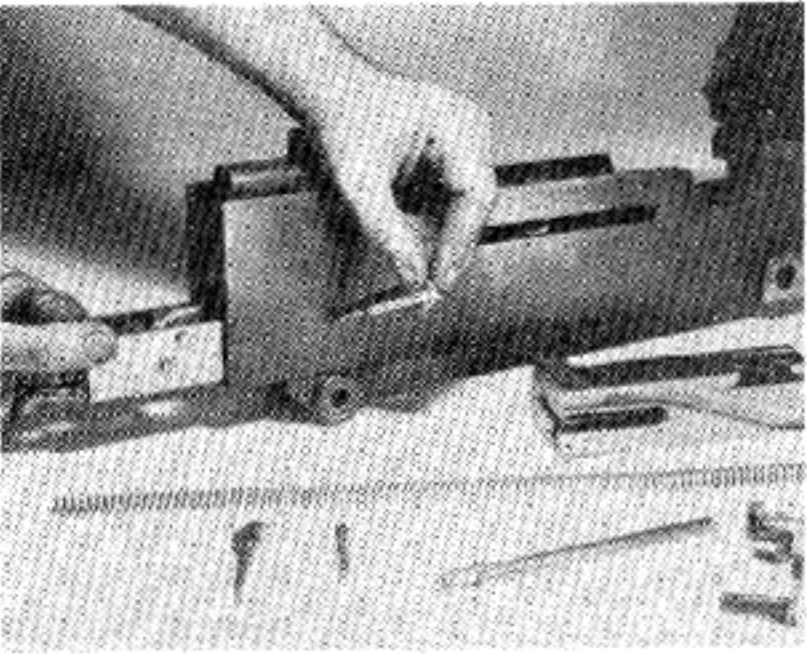

Insert the point of a bullet in the trigger pin locking hole in the lower right side of the receiver and push in the trigger pin against the tension of its spring. This frees the lock frame spacer and other recoiling parts and permits pulling them directly to the rear.

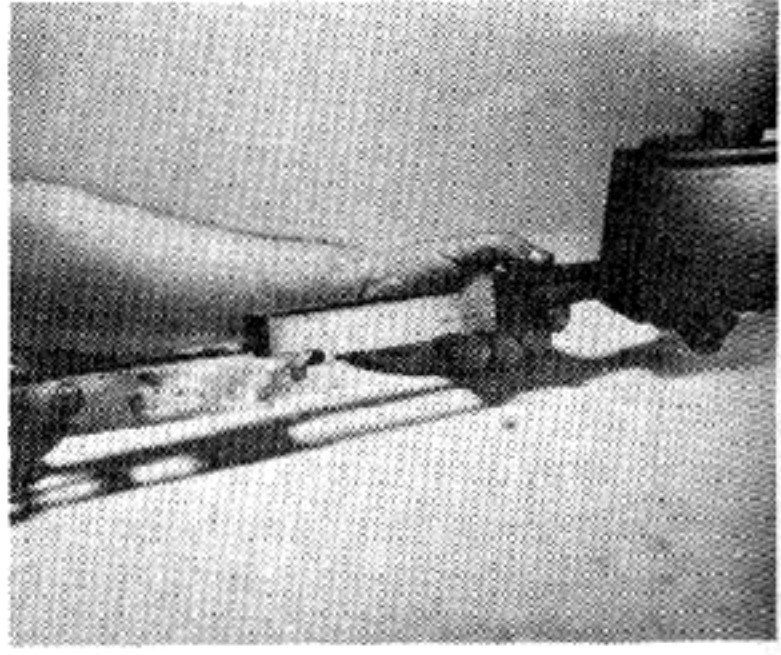

5. When the bottom projection at the rear of the barrel extension (the part screwed onto the barrel) drops below the bottom of the receiver, pull the combined lock frame spacer, barrel extension and barrel directly to the rear out of the gun.

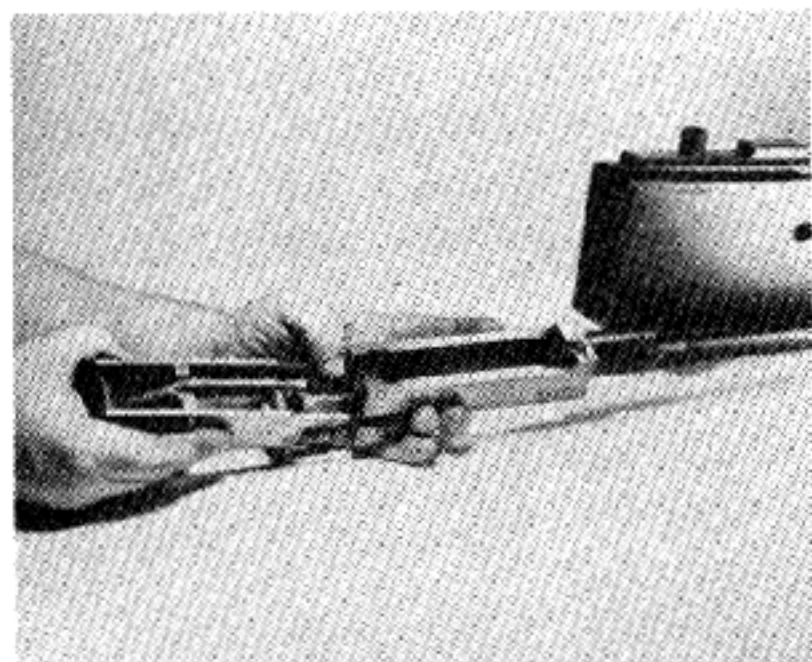

6. Grasp the lock frame spacer with the right hand, and with the left thumb, push forward on the turned up tips of the accelerator.



This will spring down and forward, separating the lock frame spacer (which holds the trigger and accelerator mechanism) from the barrel extension.

7. Push the accelerator pin out of the lock frame spacer and move the accelerator (this is the curved piece of metal with two claws).

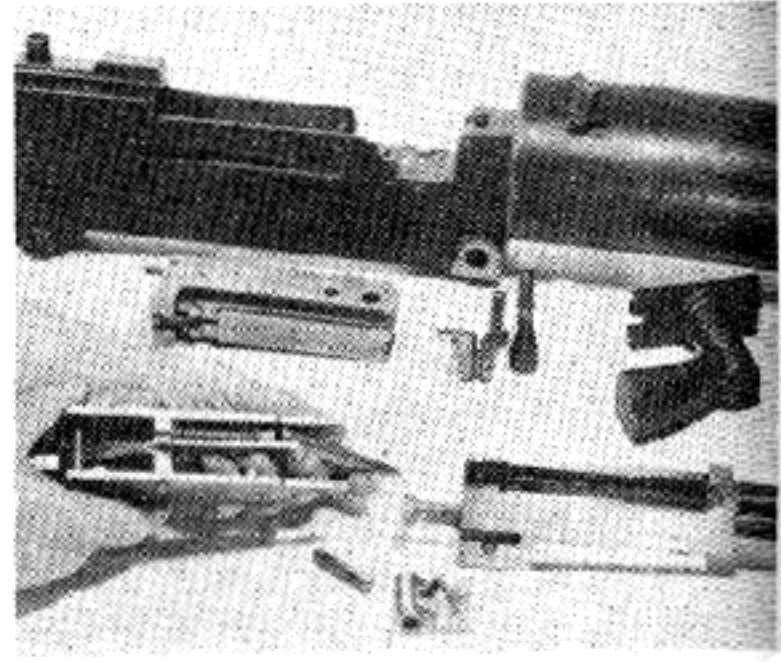

8. Insert head of cartridge in slit in head of barrel plunger at the left side of the lock frame. Twist it and ease it out. Remember that it is under strong spring tension (if necessary trigger pin may now be pushed out and spring and trigger removed).



# U. S. BROWNING .30 1917 AND 1917 A1 MACHINE GUN

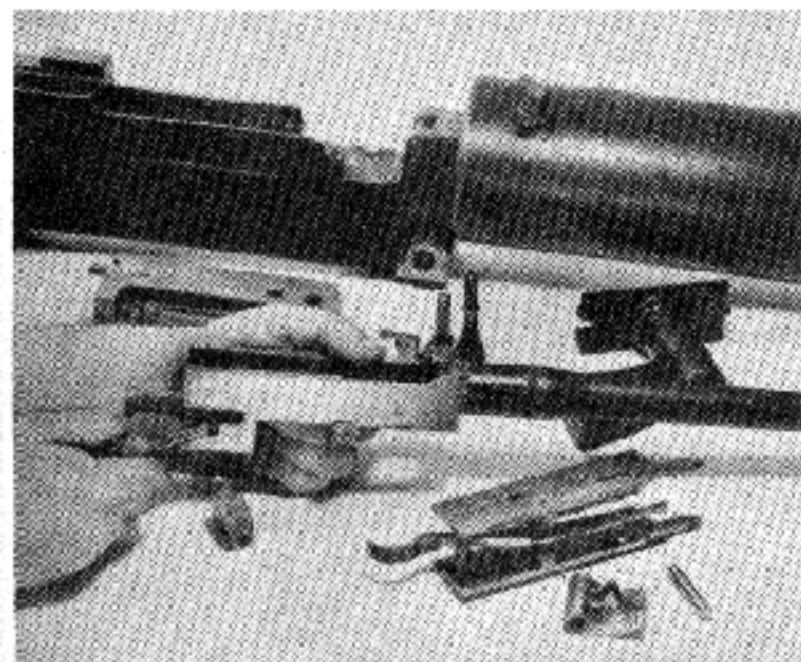

9. Holding the barrel extension with the left hand, use the point of a bullet to start the breechblock pin from left side and remove it from the right, permitting the breechblock (the heavy wedge whose lower front end is beveled) to drop down out of the barrel extension. (Barrel extension may now be unscrewed from the barrel if necessary).

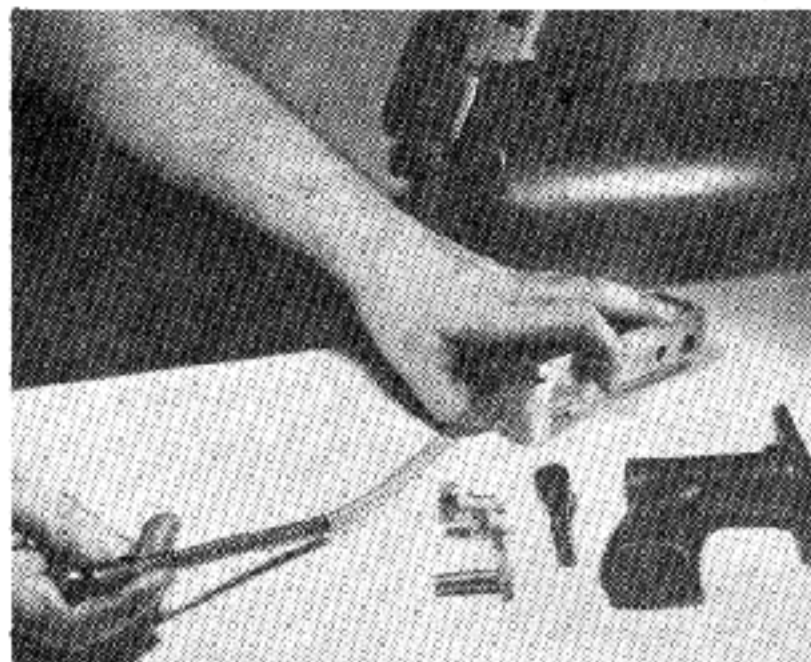

10. Turn the extractor (the swinging hook-shaped piece on the left forward end of the bolt) up as far as it will go and pull it out of its hole in the bolt.

11. With the base of the cartridge, push in the head of the driving spring rod in the bolt and twist it to the left. Be careful of the very powerful driving spring which will now be free to fly out the back carrying the driving spring rod with it. Grip this firmly and ease it out gradually.

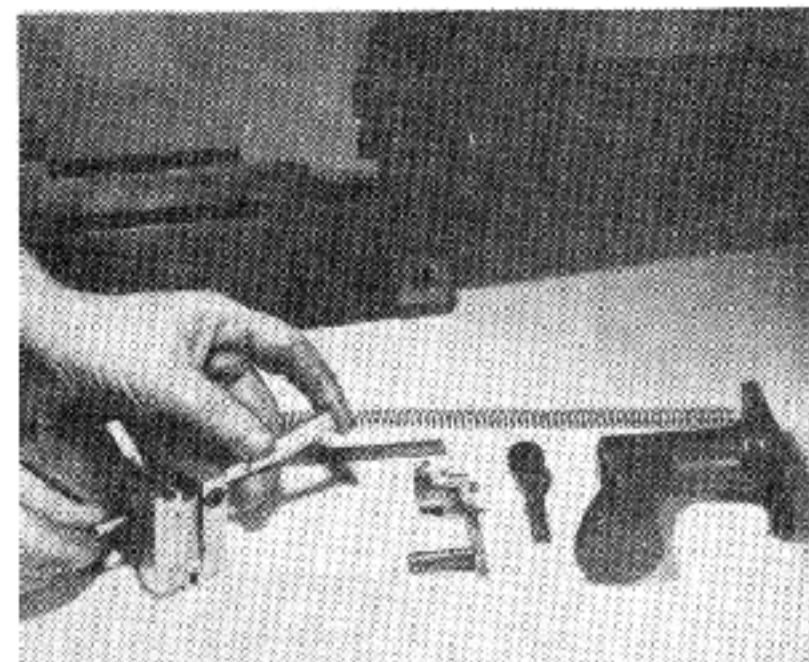

12. Push out the cocking lever pin from the upper front left side of the breechblock and lift out the cocking lever. Turning the breechblock upside down, push the sear up with the bullet to release the firing pin spring; turn the breechblock the right way up again and insert the bullet into the slot of the sear spring. Push over to the left pry the sear spring into a locking recess and the sear drops out. When sear spring is pushed back into normal position its pin may be pushed up and it and the spring removed. The firing pin and its spring may now be dropped out of the back of the breechblock.

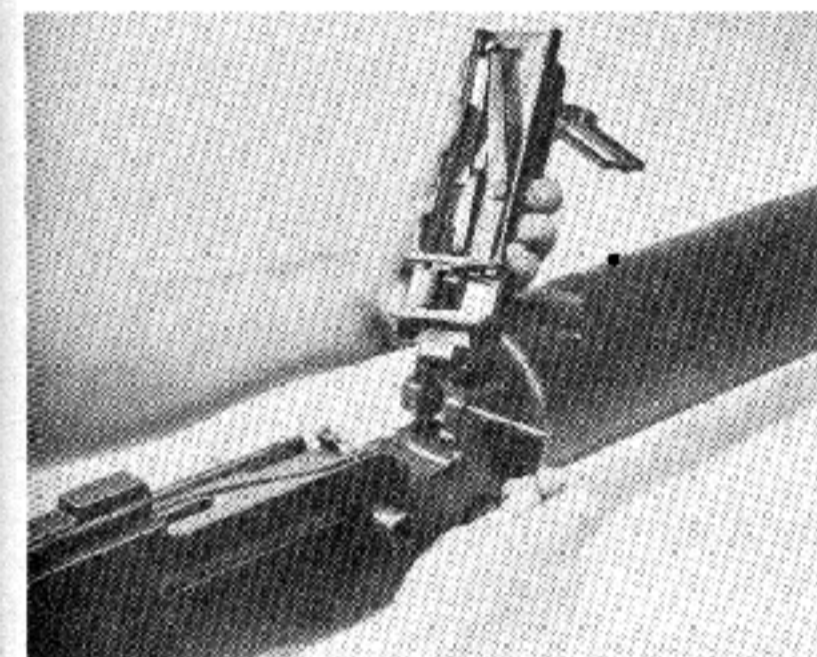

13. Use the point of a bullet to turn up the cover pin spring at the right side of the receiver just behind the water jacket. Pull the pin out to the right and lift the cover up out of the receiver.

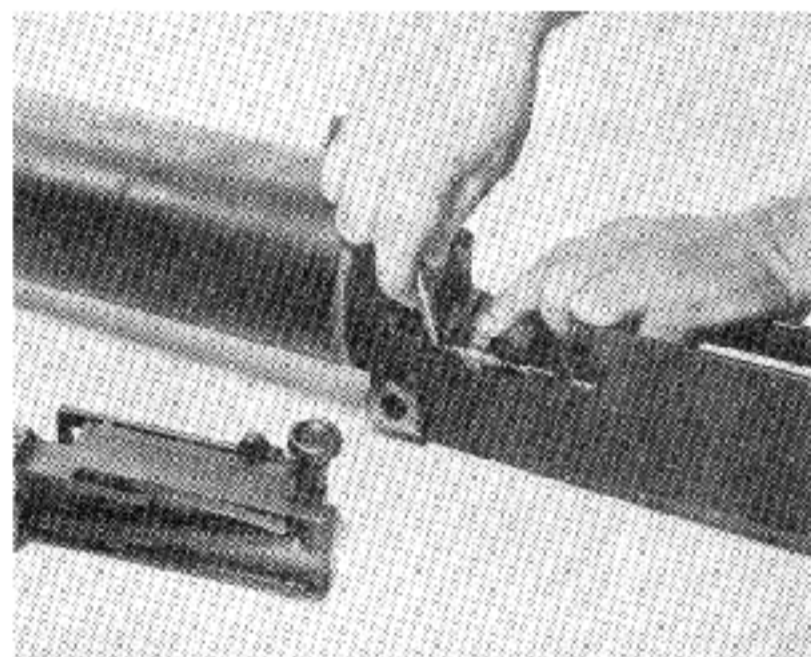

Pushing back on the nose of the split pin on the left side of the feed block, control the feed pawl with the left thumb and ease the pawl and its spring up out of the receiver as the locking pin is pulled out.

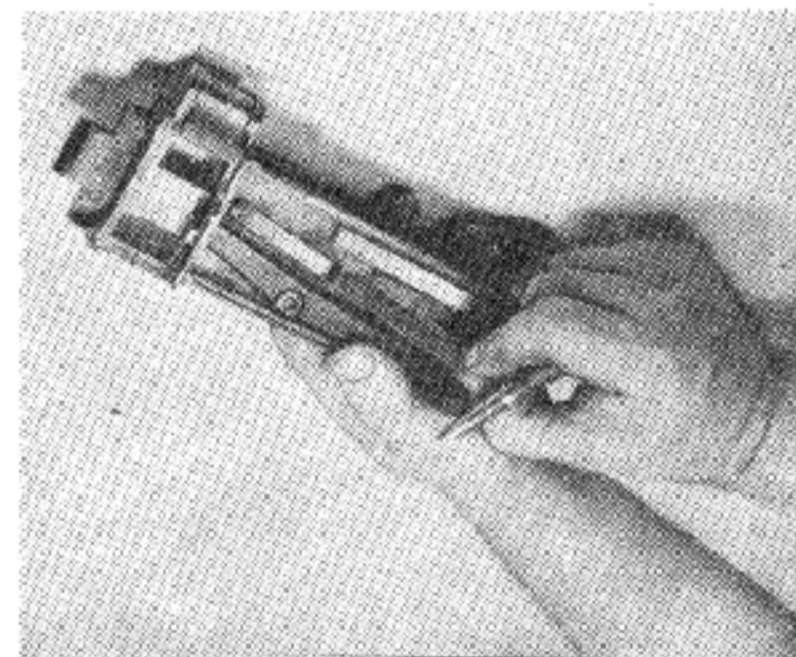

14. Insert point of bullet between the extractor cam and the long flat piece of metal on the side of the cover opposite the belt feed lever (this is the extractor spring) and pry the extractor spring out of its seat in the cam, then lift it up and out. The feed lever and slide may be removed if necessary by turning feed lever pivot pin spring outwards. This completes stripping the Browning machine gun.

## ASSEMBLING THE GUN

Start by screwing the barrel into the barrel extension, then insert the barrel and barrel extension into receiver. Slide slowly forward **until the lower projection of the barrel extension (which holds the bolt back) is against the bottom plate of the receiver.** Holding the lock frame in the right hand, place the accelerator claws between the rear face of the barrel extension and the forward faces of the T lug extension and at the same time insert the **forward projections** of the lock frame into their grooves in the barrel extension. Give a **quick thrust** forward to the lock frame to tip back the accelerator claws and compress the barrel plunger spring; this locks the lock frame to the barrel extension.

Now push the lock frame attached to the barrel extension and barrel **further ahead** in the receiver until the trigger pin on the lower right side comes against the side of the receiver. **Push in** the trigger pin against its

spring tension and the whole assembly can now be pushed fully home while the trigger pin will be forced by its spring into its slot in the right side of the receiver.

Now replace the bolt in the receiver being sure the extractor is in position and that the cocking lever projecting through the top is **fully forward.**

Insert the bolt handle in the end of the slot in the receiver and into its hole in the bolt, then push it forward far enough that when the cover latch is pushed forward the pistol grip and back plate may be slid down in their grooves in the receiver. Pull the cover latch back to lock the back plate in position; and holding bolt handle back as far as it will go, insert the base of the cartridge into the slit in the driving rod, push in and turn to the left to release the driving rod spring. Now permit the bolt to run forward under the thrust of the driving rod spring.



# U. S. BROWNING .30 1917 AND 1917 A1 MACHINE GUN

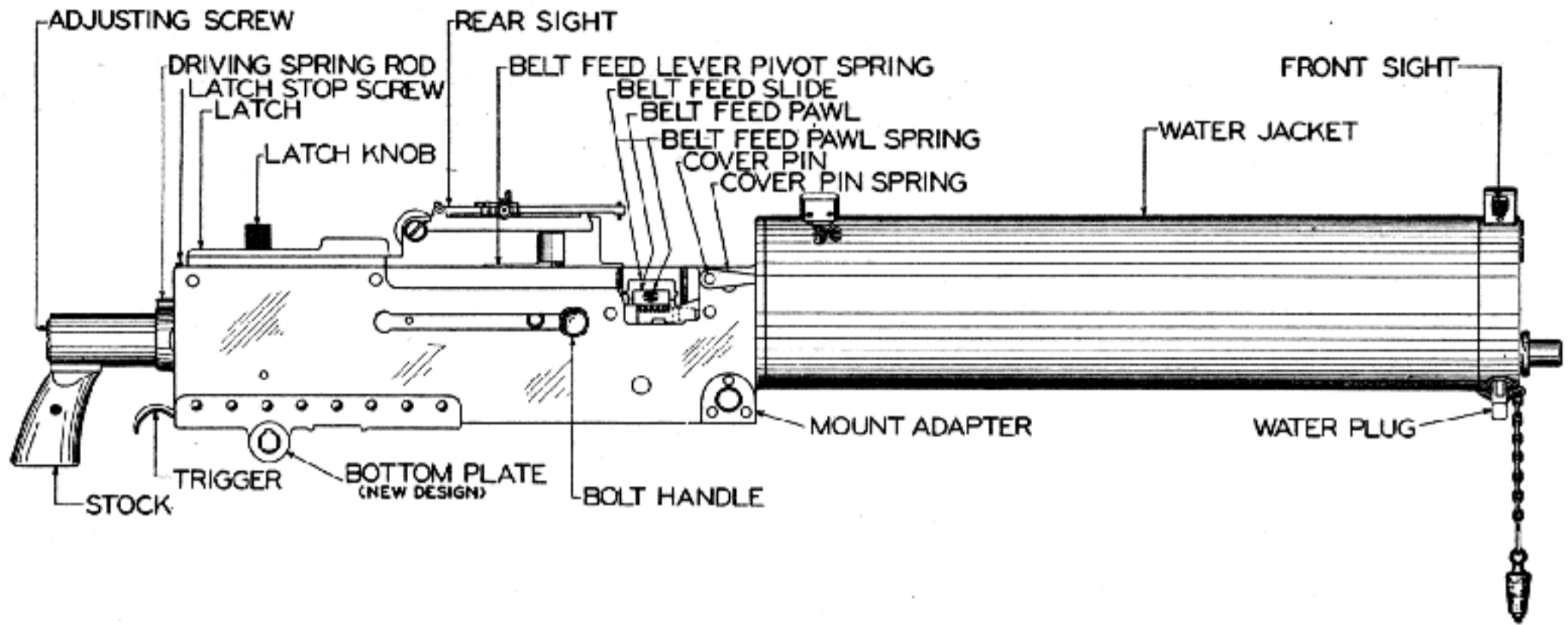

Right-Hand Side

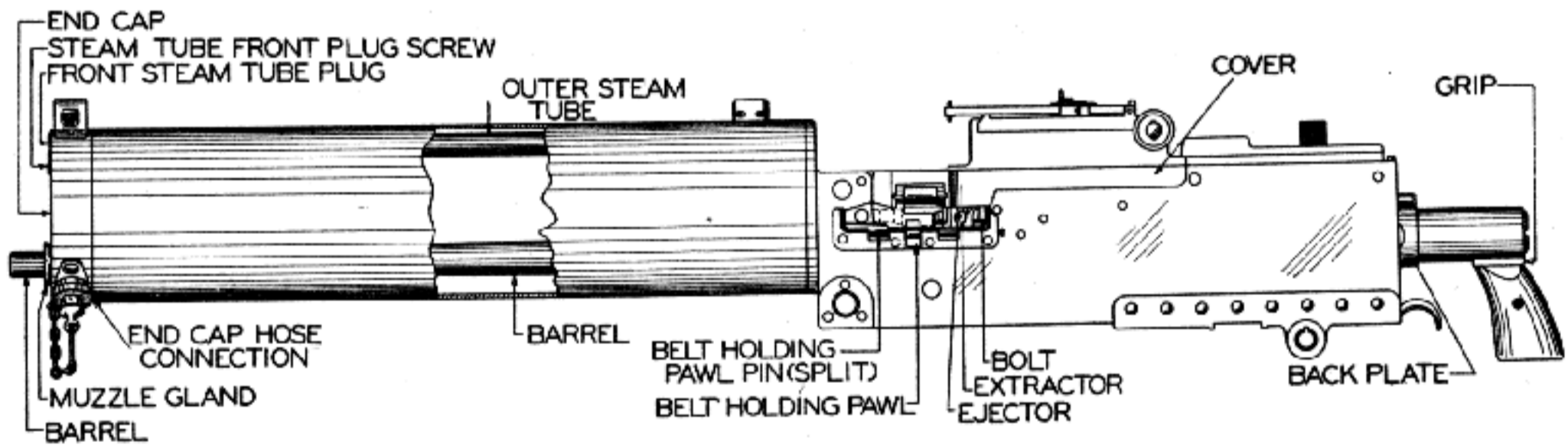

Left-Hand Side



# U. S. BROWNING .30 1917 AND 1917 A1 MACHINE GUN

## HOW THE BROWNING MACHINE GUN WORKS

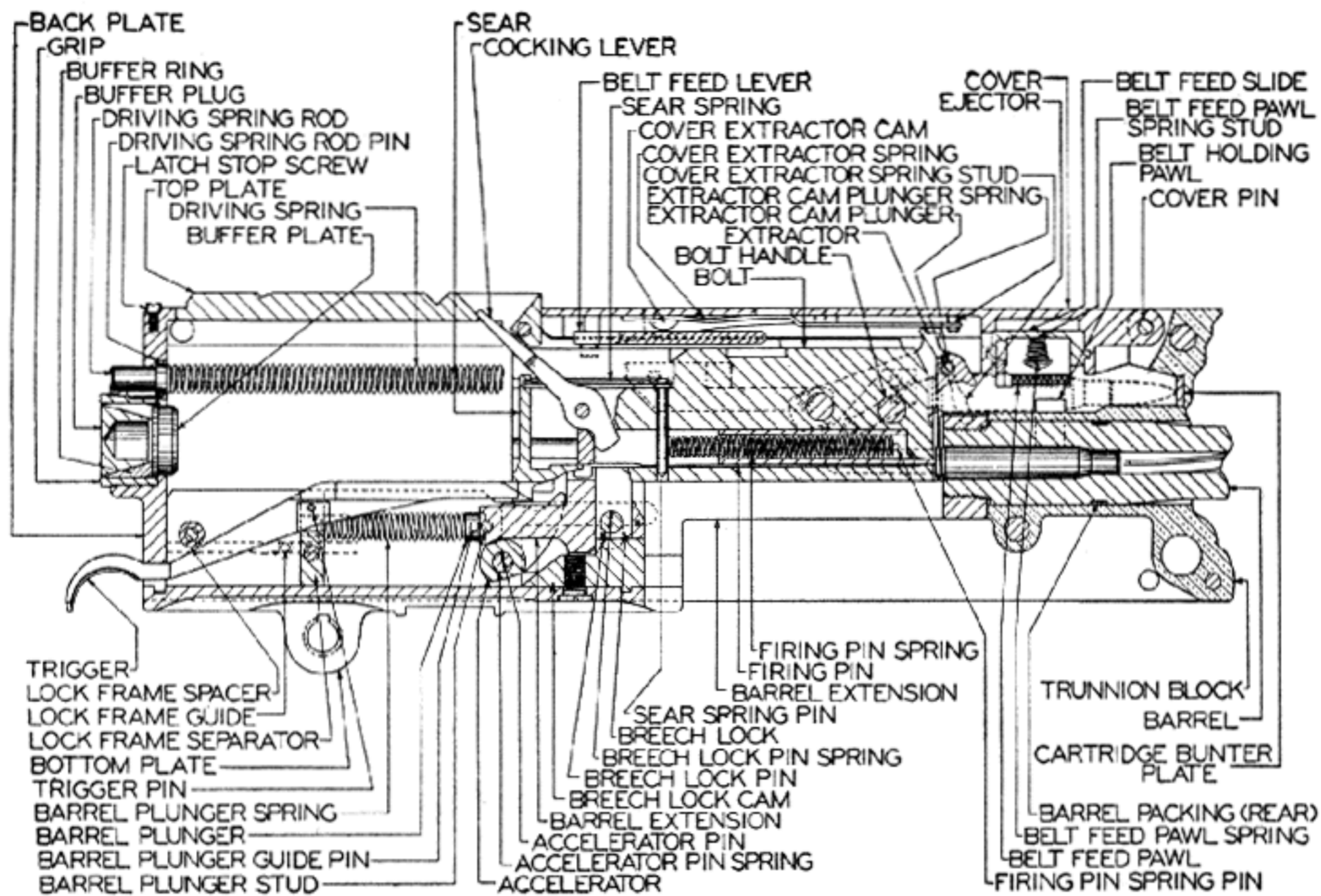

Cross-Section of Parts in Fired Position

Starting with the weapon loaded and cocked the action is as follows: The trigger being pressed, the trigger bar disengages from the sear block and allows the striker to be driven forward by the spring in the bolt to fire the cartridge.

As the bullet goes down the barrel the recoil drives back against the base of the cartridge base which transmits the blow to the bolt face thereby starting the locked recoil action and barrel to the rear.

The barrel, barrel extension and bolt recoil, locked together, about  $\frac{5}{8}$  of an inch. For the first half of this travel, during the period of high breech pressure, they are securely locked together, and then the front projections of the lock frame (which are set against the sides of the pin passing through the barrel extension and the breech block) force the breech block pin down, drawing the breech block down out of its locking slot on the under side of the breech block. The bolt is thus released from the barrel extension and so can continue straight to the rear. As the barrel extension itself travels to the rear, the barrel plunger spring is compressed and the rear of the barrel extension drives the claws of the accelerator back sharply, flipping the accelerator up and backwards on its pin.

As the accelerator turns, the tips of its claws strike bottom projections on the bolt and thus accelerate the rearward motion of the bolt by transmitting to it the thrust absorbed from the barrel extension, which is now held in rearward position locked to the frame spacer slots. Speeding the rearward motion of the bolt at the same time that the barrel is slowing up, permits the empty case to be extracted from the chamber without the sudden tug that would normally occur. (This makes special lubrication unnecessary). The accelerator claws

while engaging the shoulder of the T lug firmly lock the barrel extension in the rearward position to the lock frame. A stop prevents the accelerator from going backwards too far and the barrel plunger spring is held compressed.

During backward motion of the bolt, the driving spring is compressed over the driving spring rod whose head is held securely in the back plate of the receiver. The extractor fitting over the top front of the bolt draws a loaded cartridge from the belt at the same time that the T slot machined into the face of the bolt draws the empty cartridge case from the firing chamber. The extractor cam plunger (which rides along the top of the extractor cam and the extractor feed cam) is finally forced in by the beveled section of the extractor feed cam. The cover extractor cam thus forces the extractor down and the plunger spring out behind the extractor feed cam.

During the backward movement of the bolt, a stud on the belt feed lever (which is mounted in the front of the cover on a pivot) moves to the right in the cam groove cut in the top of the bolt. Thus the belt feed slide which is attached to the lever is moved to the left. The belt feed pawl (located on the under side of the cover above the belt) springs over the left of the first cartridge (which is being held in position by the belt holding pawl below the belt on the left side of the feed block) and supports the cartridge and the belt to prevent feeding trouble.

The cocking lever is fastened by a pivot pin inside the bolt and its tip protrudes through the top of the bolt and rests inside the top cover of the receiver. Thus as the bolt starts backwards, pressure on the lower part of this lever drives it back revolving it on its axis and



# U. S. BROWNING .30 1917 AND 1917 A1 MACHINE GUN

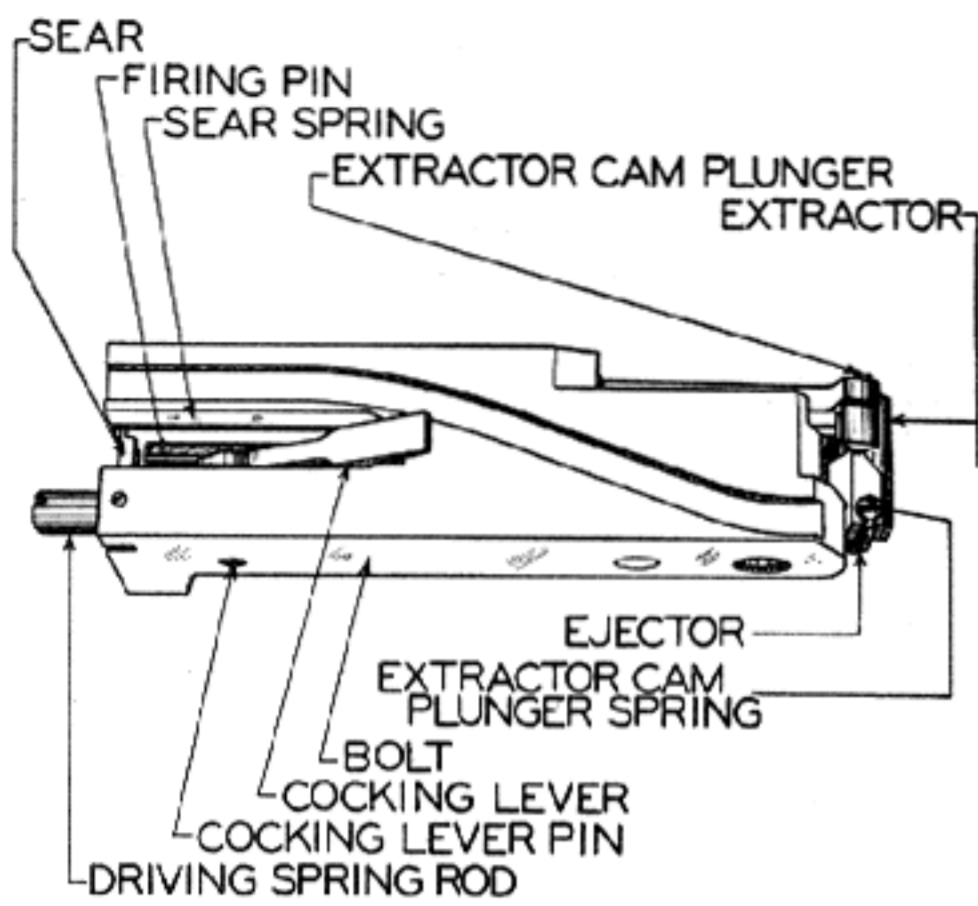

Bolt Assembly

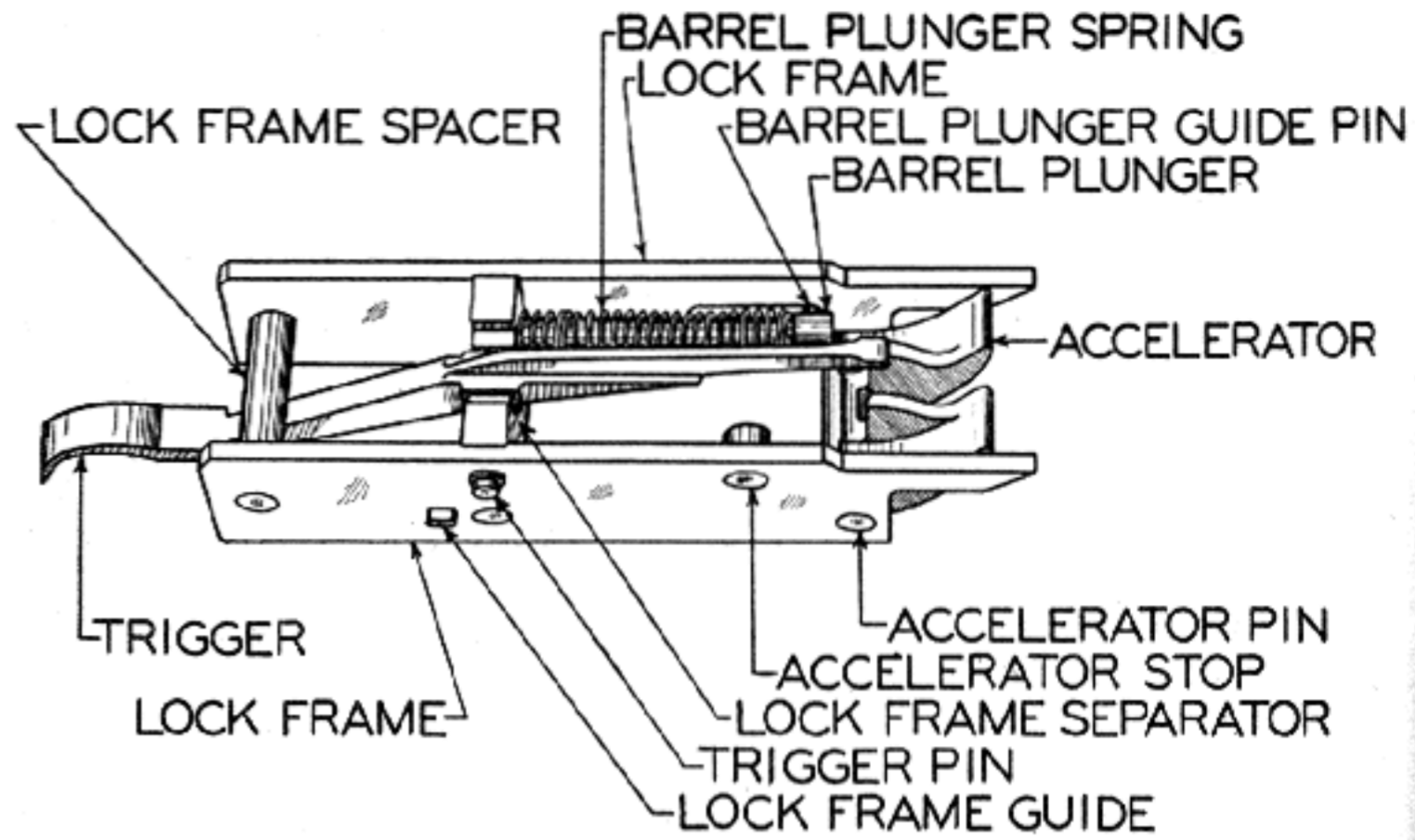

Lock-Frame Assembly

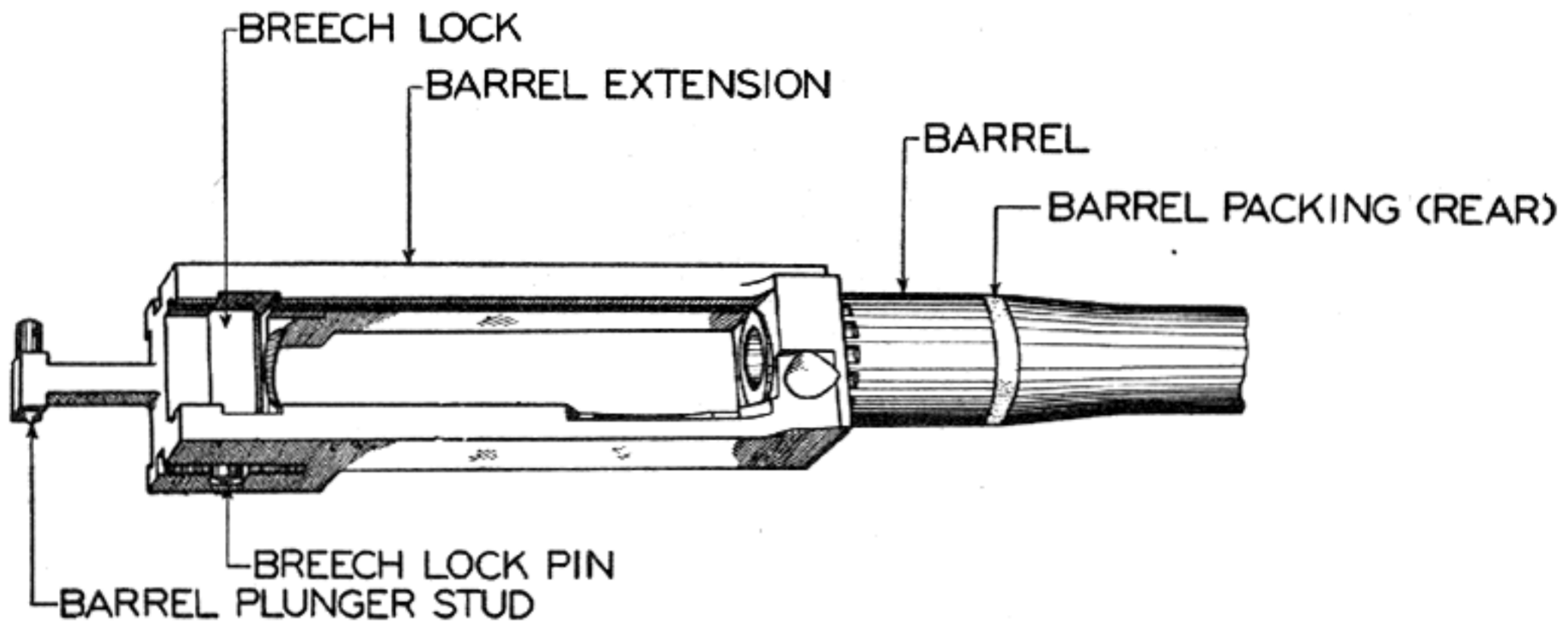

Barrel Extension Assembly

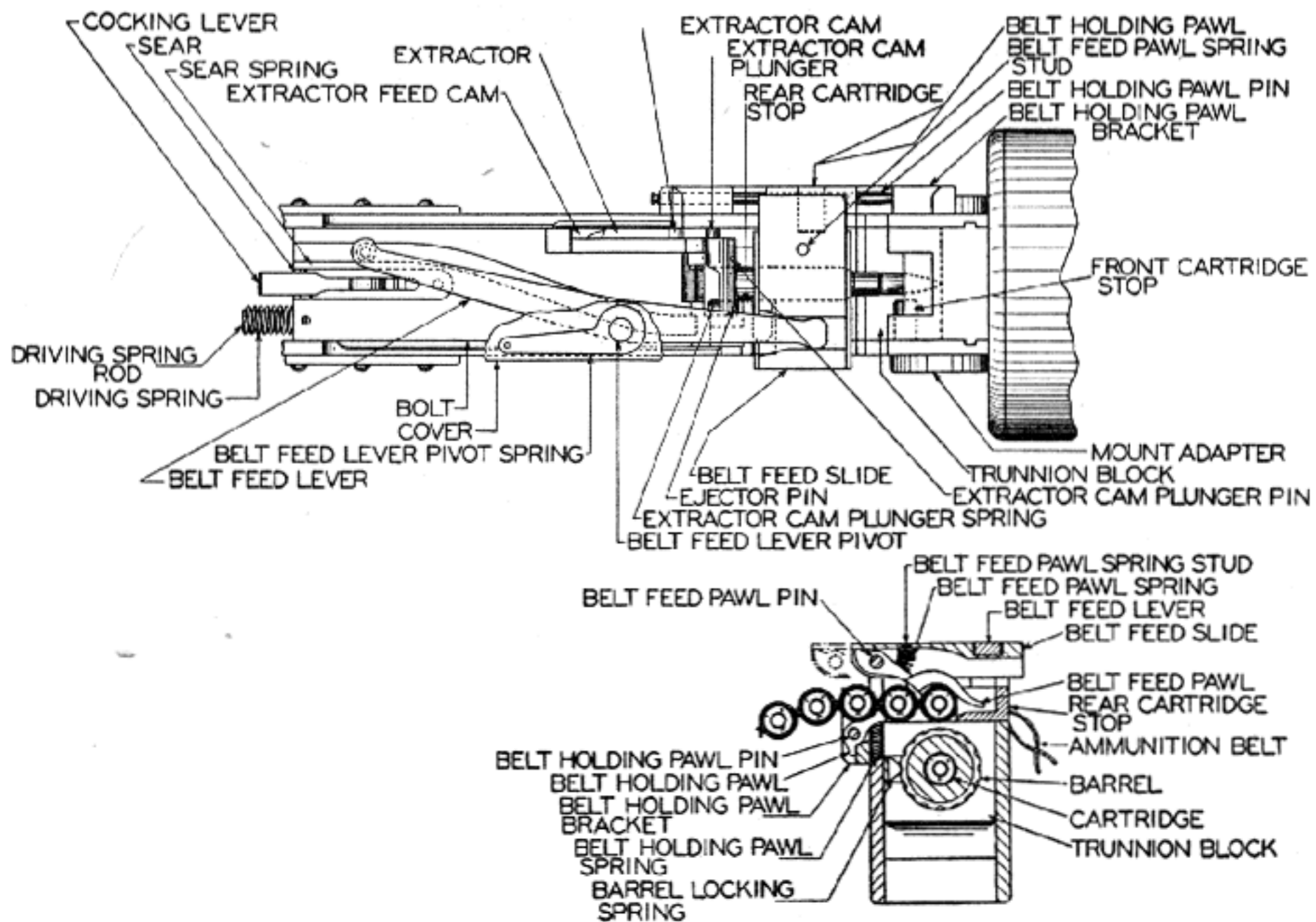

Belt-Feed Mechanism



# U. S. BROWNING .30 1917 AND 1917 A1 MACHINE GUN

the firing pin spring is compressed drawing back the firing pin. The firing pin engages a notch in the sear (which has been pulled upward by the action of the sear spring).

The rear of the bolt strikes against the buffer plate mounted in the back plate at the upper part of the pistol grip and the remainder of its energy is absorbed in friction and by the buffer disc (a brass buffer ring is forced over a plug and expands against the inner wall of the grip).

The driving spring in the bolt which is now fully compressed reacts to drive the bolt forward. During this forward motion, the upper end of the cocking lever is forced to the rear, thus pulling the lower end away from the rear of the firing pin. The extractor feed cam acts on the extractor cam plunger, forcing the extractor down so that the cartridge it is holding drops down the T slot in the face of the bolt until it reaches a direct line with the firing chamber. The ejector strikes the empty case in the T slot expelling it through the bottom of the gun and stopping the live cartridge when properly positioned.

Also during the forward motion of the bolt, the bottom projection strikes the top of the accelerator to swing it forward on its axis pin. This unlocks the barrel extension from the lock frame, permitting those two units to move forward as the bolt acts through the accelerator against the rear end of the barrel extension. The forward motion of the barrel extension and barrel is further assisted by a thrust from the barrel plunger spring as it uncoils. The force passed on by the accelerator from the bolt to the barrel extension is suffi-

cient to guarantee proper timing of the locking action.

The actuating stud on the feed lever fits down in a cam groove in the bolt. Thus as the bolt goes forward, the stud rides in the cam and forces the lever on its pivot to the left; the forward end of the lever which carried the feed slide is thus pivoted to the right, bringing with it the belt feed pawl, the belt and the next cartridge. As the motion ends, the cartridge to be fed is held between the cartridge stops and the feedway. The next round to load is pulled over the belt holding pawl which rises behind it. It is in position to be engaged by the belt feed pawl on the next movement.

The final action of the extractor during forward motion of the bolt is to rise under the influence of its plunger riding along the top of the extractor cam. As the ejector pivots forward, the extractor releases its hold on the cartridge which is now well into the chamber. The extractor continues to ride upwards and over the base of the **next cartridge in the belt in the feedway**. Then the flat extractor spring in the top cover forces the extractor down and into the cannellure of this cartridge gripping it ready to pull it back on the next movement to the rear of the bolt.

The breech block, mounted in the rear of the barrel extension, strikes a cam as the recoiling parts near the firing position; and is forced up this cam and into a recess cut in the bottom of the bolt. Thus as the action comes to a complete close, the breech block firmly locks the barrel extension (into which is screwed the barrel) to the breech block.

## SPECIAL NOTE ON ADJUSTMENTS

It is extremely important that the headspace on this gun be correctly adjusted before firing. To test the adjustment, pull the bolt handle back and let it run forward several times.

If the bolt does not go home fully and smoothly, it indicates too tight space between the face of the bolt and the face of the firing chamber. If the gun is put into use in this condition, it will fire sluggishly or it may refuse to fire at all.

To correct this condition, it will be necessary to strip the weapon and unscrew the barrel one notch, then assemble and test again.

**To test for loose Head Space:** Lift the cover and raise the extractor; then pull the bolt slightly to the rear. If the bolt moves back at all without carrying the barrel and barrel extension with it, then gun is too loose. Fired in this condition, the pressure of the gas in the firing chamber will bulge the head of the empty cartridge case (since it is not fully supported by the bolt), or may rip it off entirely, causing a serious jam.

To correct this condition, screw up the barrel one notch, then retest.

**Adjusting Head Space:** Screw the barrel into its ex-

tension and stop when the first clicking sound is heard (this click is caused by the barrel-locking spring).

Push the breech block (minus extractor) fully forward on barrel extension.

Push the lock piece up from below to lock the breech block to the barrel extension; and while holding it firmly, screw up the barrel until resistance is encountered.

Now check to see that barrel locking spring is in a notch and that the lock piece is solidly seated.

Now let go of the lock. If it drops freely, the adjustment is correct. This adjustment should be punched on the barrel, to save time when assembling in future.

**Water Leakage:** If water leaks from muzzle end, remove muzzle gland and wind oil soaked asbestos packing around the barrel. Press it together with combination tool. Then push back on barrel and guide the packing into its seat. Screw a gland back on. Test by working bolt handle. If there is friction, packing is too tight. This will make a sluggish gun.

If water leaks from breech end, remove barrel and work oiled packing down into barrel cannellure with combination tool. Test as before for undue friction.



# JOHNSON LIGHT MACHINE GUN

(Used by U. S. Marines)



**Caliber:** .30 U. S.

**Magazine:** Detachable box.

**Capacity:** 20 cartridges. Single column feed.

**Positioned:** On left side of gun. When empty it may be removed and replaced or may be loaded from right side of gun through loading gate with single cartridges or Springfield 5-shot clip.

**Ballistics:** Standard for cartridges employed.

**Barrel Length:** 22" standard.

**Overall Length of Gun:** 42".

**Weight Without Magazine:** 12½ lbs.

**Weight of Loaded 20-round Magazine:**

**Sights:** Special Lyman-Johnson rear peep sight with two automatic fire apertures set for long or average battle range. Adj. in ½ minute clicks.

**Gun Operated by:** Recoil. Barrel recoils ½" during which time the unlocking takes place. Straight line main spring behind bolt is compressed by rearward action to provide energy for forward motion of the gun.

**Locked:** By rotary bolt with 8 lugs.

**Cooled:** Air. Gun has perforated cooling jacket about rear section of barrel. Also gun is fitted with a device to permit keeping the bolt open between shots, thus permitting circulation of air through breech and barrel.

**Position of Cocking Handle:** Right side of receiver.

**Type of Fire:** Single shot or full automatic. Change lever is on right side of Gun above trigger. In center it is safe; pushed to the rear it is automatic; pushed to the front it will fire single shots.

**Special Feature:** This is the only weapon made which may be fired from either a closed or an open bolt. Used as a semi-automatic weapon for accurate fire, the bolt is closed to prevent disturbing the aim by movement of the heavy parts going forward. Turning the change lever on the Johnson to the forward or semi-automatic position, allows the bolt to go forward and lock without firing a cartridge. When the trigger is pulled, one cartridge is fired and the gun is cocked and the bolt is closed ready for the next shot.

When firing automatically, bolt should be open to permit air circulation and prevent a cartridge in the firing chamber being cooked off by barrel heat during suspension of fire. This is achieved in the Johnson by setting the change lever back at the automatic position. The bolt will stay open in this position and will go forward to fire the cartridge when the trigger is pressed. The gun will continue to function until trigger is released or the magazine is empty.

## LOADING AND FIRING:

1. Loaded magazine is inserted in the housing on left side of rifle. If the weapon is to be fired single shots, set change lever at forward position for semi-automatic. If weapon is to be used full-automatic, set change lever at rear position for full auto.

2. Pull bolt back as far as it will go. If set for semi-automatic bolt will run forward and drive cartridge into firing chamber ready for full press of the trigger. If change lever is set for full auto, bolt will stay open and will go forward when trigger is pressed to fire cartridge

and continue firing cycle as long as trigger is held.

3. Magazine release catch is on top of magazine housing. Pressing it down releases magazine to be withdrawn from the gun when empty.

4. A loading gate is provided on the right side of the gun. Single cartridges or Springfield clips may be inserted into the gate from the right hand side and forced through into the magazine. This permits reloading magazine while partly empty.



# JOHNSON LIGHT MACHINE GUN

## FIELD STRIPPING

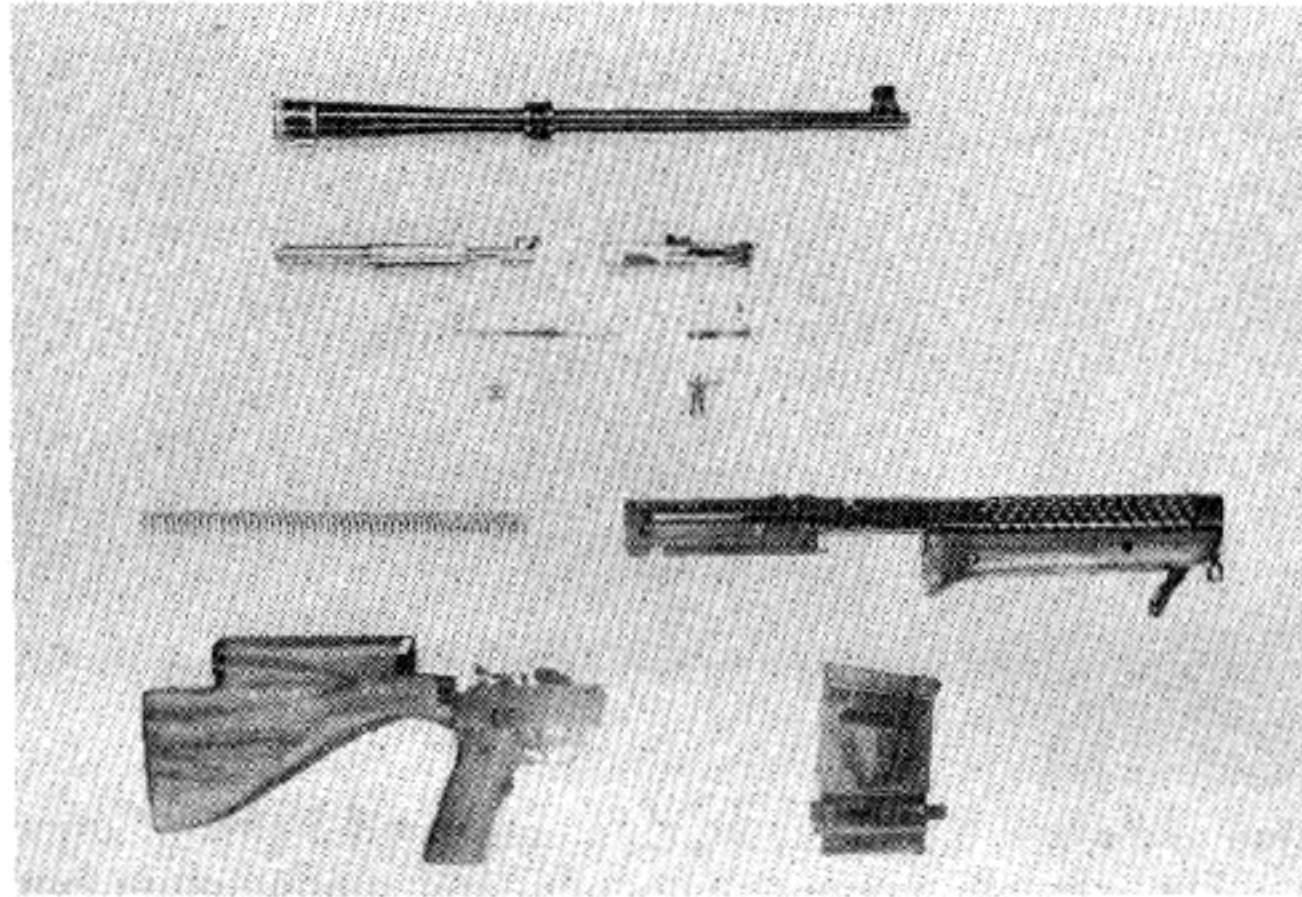

1. Push in barrel latch with point of bullet to disengage the latch and pull out the barrel.
2. Buttstock is held by a thumb latch which may be pushed to permit buttstock to be removed.

3. Press cover of magazine support and slide the support to the rear withdrawing it.
4. Bolt assembly may be withdrawn after sliding off the operating handle which is locked by a spindle.

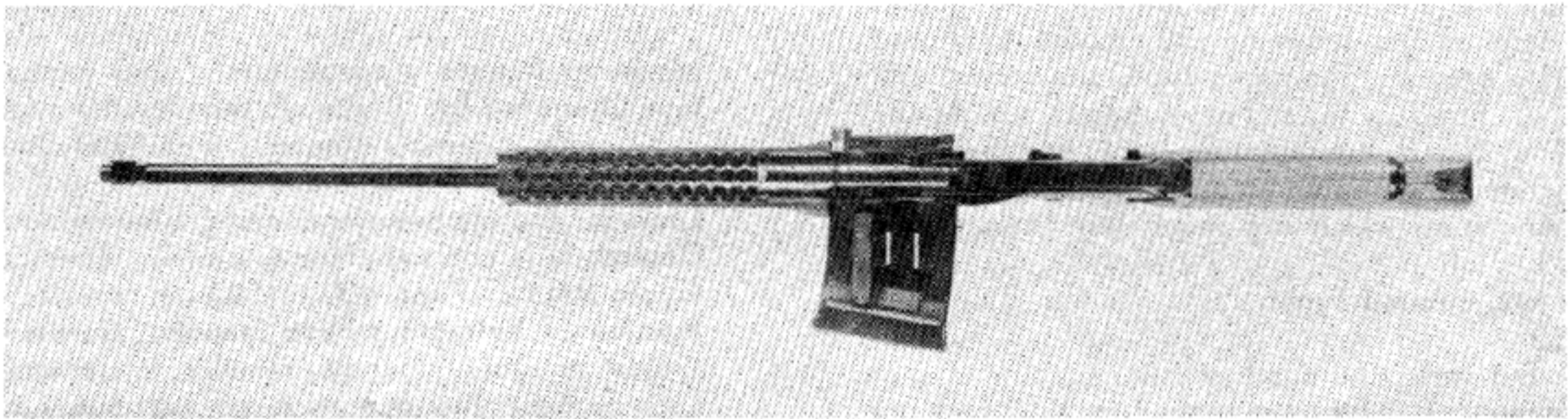

View Showing Magazine, Catch, and Bolt Handle

## HOW THE JOHNSON LIGHT MACHINE GUN WORKS

Starting with the weapon loaded and the gun cocked, the action is as follows:

The trigger being pressed the connecting sear is released from the bolt letting the bolt be driven forward by the recoil spring in the butt. The bolt picks up the cartridge from the magazine and drives it toward the chamber, the extractor snapping into the cannellure at the proper moment.

When the bolt goes forward a locking cam at the rear end of the bolt group causes rotation and locking of the bolt as the bolt reaches its fully closed position. This rotary action pushes the bolt through an arc of 20° bringing the 8 locking lugs distributed around the bolt head into their corresponding recesses on abutments in the barrel locking bushings.

This locking cam also carries the firing pin which now goes forward to fire the cartridge.

**Rearward Movement of the Action:** When the cartridge is fired, and the bullet travels down the barrel, the barrel and the bolt recoil together about  $\frac{1}{8}$  of an inch until the angular face of the operating cam comes against the corresponding face in the receiver. This imparts a twisting motion which causes the bolt to rotate far enough to free the 8 lugs from their re-

cesses, which happens during the next  $\frac{3}{8}$ " of travel.

After a recoil of about  $\frac{7}{16}$  of an inch, the barrel is stopped and the bolt continues on to the rear carrying the empty cartridge case by the extractor in its face.

At this point there still remains sufficient pressure in the chamber working back against the inside of the cartridge case to help extraction. As this weapon is pitted with a straight line buttstock as in the case of the German MG-34 and MG-42, the coil mainspring is in direct line behind the bolt and is compressed as the bolt travels to the rear.

When the bolt passes the end of the magazine, a buffer plunger at the rear of the locking cam is compressed when it touches the base of the mainspring tube in the buttstock. At this point the rearward motion of the weapon is stopped and the bolt starts its forward motion.

**Note:** Barrel 20", 22" and 24"—22" is standard.

Capacity of gun when fully loaded is 25 rounds.  
Cyclic rate with normal buffer tension 400 to 450 a minute.

Rate changed by varying tension of buffer spring.  
Capable of adjustment of 300 to 900 rounds.  
Weight of Magazine empty—14 oz.



# U. S. BROWNING .50 M2 MACHINE GUN

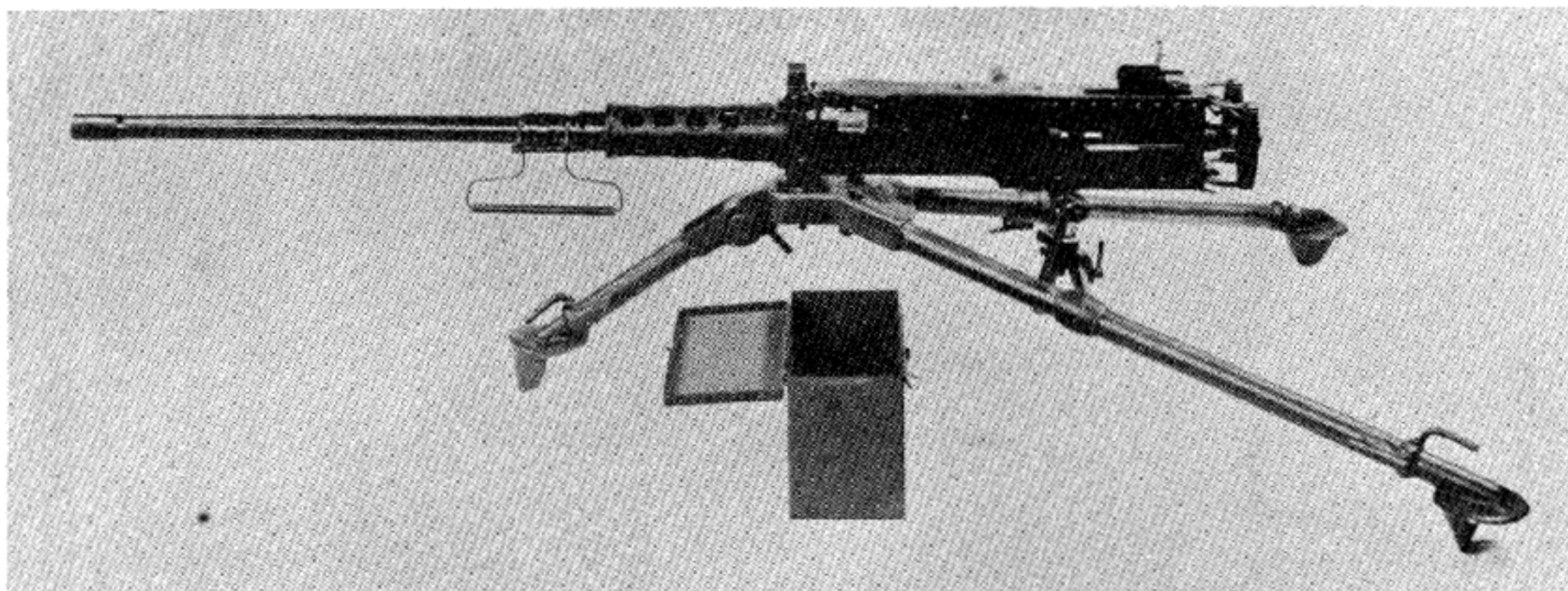

This gun is produced with three different types of barrels for various types of use. The aircraft model, fitted with a perforated barrel jacket or casing weighs 64-pounds. This is a fixed-type machine gun whose general design, except for firing mechanism, resembles that of the other types.

The antiaircraft model is fitted with a water jacket as in the case of the Browning .30, model 1917 and weighs 121½ pounds. The third type, the model HB, M2, Ground, fitted with a heavy barrel weighs 81 pounds. This gun is designed for tank and field use and its description will serve for a better understanding of the other types, which are much less likely to be encountered.

**Model HB, M2, Ground Type:**

**Caliber:** .50.

**Feed:** Belt fed with 100-round belts.

**Muzzle Velocity:** 2400 feet per second to 2660 feet per second.

**Barrel Length:** 36" or 45".

**Overall Length of Gun:** 56".

**Weight:** 54 pounds without barrel.

**Barrel Weight:** About 25 pounds for the 36" and about 30 pounds for the 45" length.

**Weight of Loaded 100 Round Belt:** About 31 pounds, without ammunition chest. Chest adds about 4½ pounds to the weight.

**Sight:** Telescopic. Weighs 3 pounds.

**Standard Sights:** Customary front and rear. Rear sight leaf graduated in both yards and mils. Yard graduation corresponds to ammunition with muzzle velocity of 2400 per second; while mil graduation may be used with ammunition of any muzzle velocity, which in this gun with special ammunition may run as high as 3,000 feet per second. The rear sight is adjustable for windage.

**Maximum Range:** Approximately 7200 yards.

**Gun Operated By:** Recoil. Except for the addition of an oil buffer assembly, the gun is basically the same as the gun caliber .30, model 1917.

**Locked:** Browning system, rising breech block.

**Cooled:** Air cooled. Heavy barrel. Barrel removable.

**Cyclic Rate of Fire:** 400 to 500 per minute.

**Position of Retracting Slide Handle:** Normally on right side of gun. Handle remains in forward position throughout the operation of the gun. This differs from the caliber .30 in which bolt handle travel back and forth with the bolt.

**Type of Fire:** Full automatic only.

**Special Feature:** There is a bolt latch on this gun at the upper rear of the receiver. This securely latches the bolt in the recoil position. Instead of the pistol grip of the caliber .30, this weapon has a double spade-grip of the Vickers type attached to the back plate which carries a bolt latch release and lock as well as a thumb trigger.

## LOADING AND FIRING

To provide for mounting in aircraft or in vehicles where position or space available require a right-hand feed, this gun is fitted with a receiver which is interchangeable for right or left hand feed. Normally ground guns will be fitted with the left hand feed as in the case of the caliber .30.

Ammunition box is mounted on the left side of the gun and belt fed through the feed block from the left hand side as for the caliber .30. Pull belt through as far as it will go, and while retaining grip pull back retracting slide handle as far as it will go and permit it to run forward. This half-loads the gun. Pull the retracting handle back again as far as it will go and release it to complete loading.

Note that in this gun the bolt latch release must be locked down before bolt is retracted for loading the

gun.

Unlock the bolt latch release by pressing down on it. Pressure on the thumb trigger will now fire the gun. It should be fired only in short bursts.

**To Unload the Gun:** Lift the cover and remove the belt. Pull back the retracting slide handle and look and feel in the feedway, the slot and the chamber to be sure the gun is unloaded.

Release the bolt and let it go forward and then lower the cover.

Press the trigger. If the bolt latch release is unlocked, alternately pressing the trigger, then the bolt latch release will fire the single shots.

If the bolt latch is locked down and the trigger pressed and held, the gun fires until the trigger pressure is released.



# U. S. BROWNING .50 M2 MACHINE GUN

## FIELD STRIPPING

Grasp the barrel handle firmly and unscrew until the barrel is free from the barrel extension, then withdraw it to the front.

Release cover latch and raise cover as far as it will go.

Release back plate latch lock and also the back plate latch; this will permit the back plate to be lifted up out of the top of the receiver.

Push the protruding end of the driving spring rod forward and away from the slide plate and ease out the spring and the rod.

Pull the bolt back until the bolt stop lines up with the hole in the center of the slot in the side plate and then pull the bolt stud out to the right.

The complete bolt may now be removed from the rear of the casing. Driving spring unit need not be removed.

Insert the point of a bullet in the small hole at the rear of the right side plate to compress the oil buffer body spring lock. Oil buffer, barrel extension and the barrel assembly may now be taken back and out of the gun.

Pressing the accelerator forward permits the oil buffer assembly to be detached from the barrel extension.

This completes field stripping. Cover should not be removed or dismantled except for repairs, as considerable force is required to compress the pawl spring for reassembly, making this a difficult operation.

## FIELD ASSEMBLY

Reverse the dismantling procedure.

Insert oil buffer into the oil buffer body from the rear, making sure that the cross groove in the piston is on the upper side where it can engage the shank of the barrel extension.

Assemble the buffer and buffer body to the extension. Holding the accelerator up under the barrel extension shank, start the breech lock depressors into their guide-way in the barrel extension, and press forward permitting the shank of the barrel extension to engage the cross groove in the piston rod. Thrust sharply forward as far as oil buffer will go. The parts will now lock together and may be assembled into the receiver as a single unit. Press forward until the oil buffer spring locks in its recess in the right side plate.

Insert extractor in bolt and check that cocking lever is fully forward. Then insert bolt into rear of receiver. Press the rear end of the bolt down to elevate the front end just enough to clear the accelerator, otherwise the accelerator will be tripped and will not permit the bolt to be moved forward. When the accelerator has been cleared, raise the rear of the bolt to clear the buffer body. To do this it will be necessary to raise the bolt latch by reaching under the rear of the top plate with thumb or finger of one hand, while the other hand

pushes the bolt forward. Bolt latch must be kept in raised position until rear of bolt passes in front of it. If this is not done, its spring will force it downward and engage the notch in the rear of the bolt preventing the bolt from going forward.

Push the bolt forward until the bolt stud hole lines up with the hole in the slot in the side plate; then insert the bolt stud until its shoulders are inside the side plate.

Insert the driving spring rod assembly and push the bolt all the way forward and keep the stud at the rear end of the driving spring rod at the recess in the right side plate.

Holding out the back plate latch lock, insert the back plate from the top. Press the trigger.

Make sure that the bolt is fully home, then close the cover. If the bolt is not fully forward, the feed lever will be forced down in front of the bolt which may result in malfunctioning.

Holding barrel by barrel handle, use both hands to insert it carefully in the front end of the barrel support. Guide the rear end over the breech bearing until it contacts the threads of the barrel extension, then screw it in until definite resistance is met. Now back off two notches to make headspace adjustment.

## HEAD SPACE ADJUSTMENT

As in the case of the Browning .30 machine gun, the headspace adjustment is the most important adjustment on this gun. It is not however necessary to remove the barrel to make this adjustment on the caliber .50.

Remember that headspace adjustment indicates the space between the rear end of the barrel and the front face of the bolt; and that if this space is too loose the gun will function sluggishly or not at all and may pull the head away from the cartridge case causing serious jams; while if it is tight, the recoiling parts will not go fully home and the gun may refuse to fire.

Screw the barrel up tight into the barrel extension, then pull back the slide and let bolt go forward to test the action.

If the action does not close fully, unscrew the barrel one notch. Then the test should be made again by pulling the bolt back and then letting it go forward.

The barrel may be unscrewed a notch at a time by pushing with the point of a bullet to rotate the barrel when the cover is raised and the bolt is in rearward position.

Work the bolt by hand several times and if the breech does not close without effort, unscrew the barrel one notch.

Raise the cover and lift the extractor, then pull the bolt slightly to the rear. If it moves independently of the barrel extension, the adjustment is too loose. Screw the bolt up one notch and then repeat the test. When a dummy cartridge is in the chamber, there must be no rearward motion of the bolt independent of that of the barrel extension before the unlocking action takes place.

Headspace test should be made whenever gun is prepared for firing.



# U. S. BROWNING .50 M2 MACHINE GUN

## HOW THE GUN WORKS

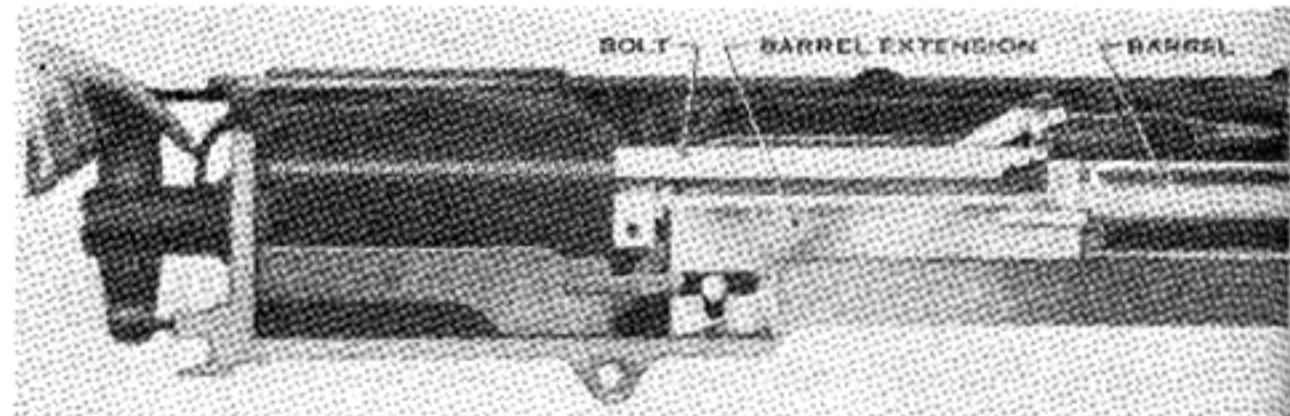
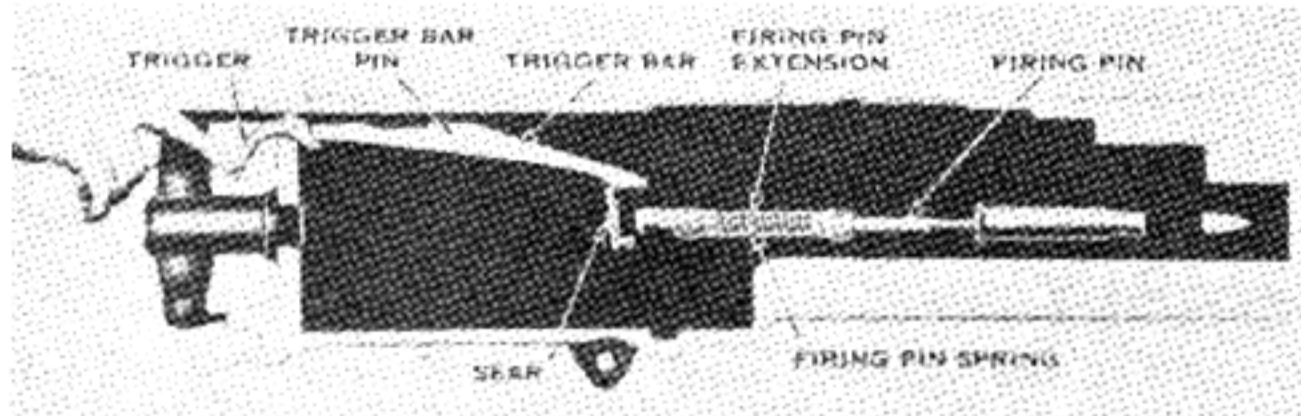
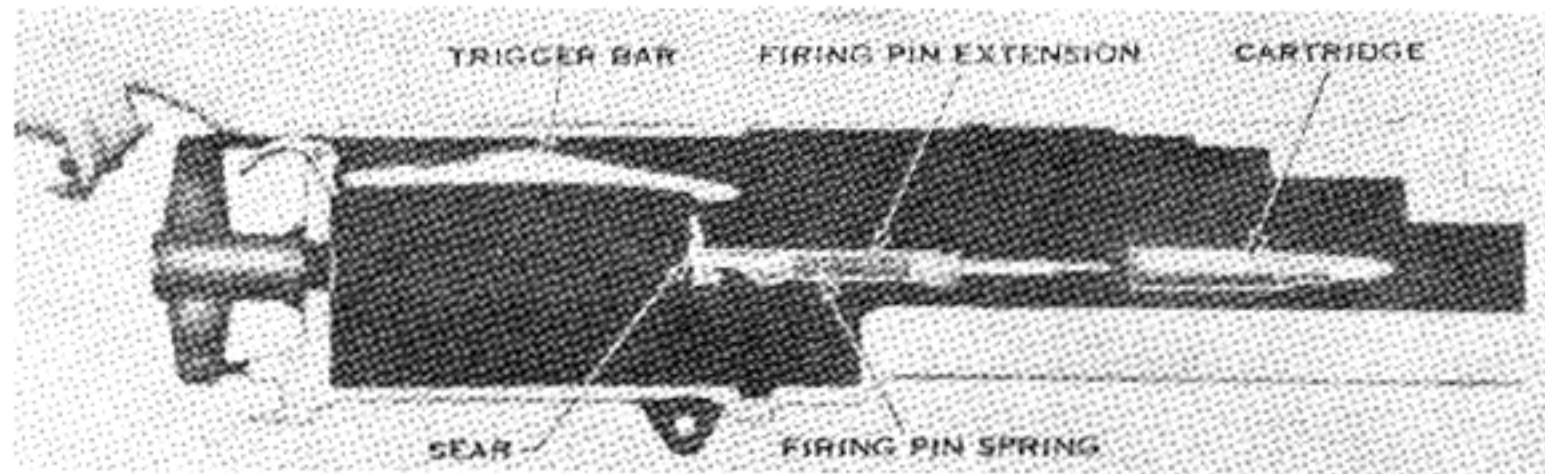

Starting with the gun loaded and cocked, the action is as follows: Pressing the trigger raises the back end of the trigger bar which pivots on the trigger bar pin and presses its front end down on the top of the sear. The sear is forced down until its notch disengages from the shoulder of the firing pin extension. This permits the firing pin extension and the firing pin to be driven

forward by the coiled firing pin spring. The firing pin strikes the primer of the cartridge and explodes the powder.

**Recoil Action:** As the bullet starts down the barrel, the rearward force of the recoil drives the securely locked recoiling mechanism directly to the rear. During

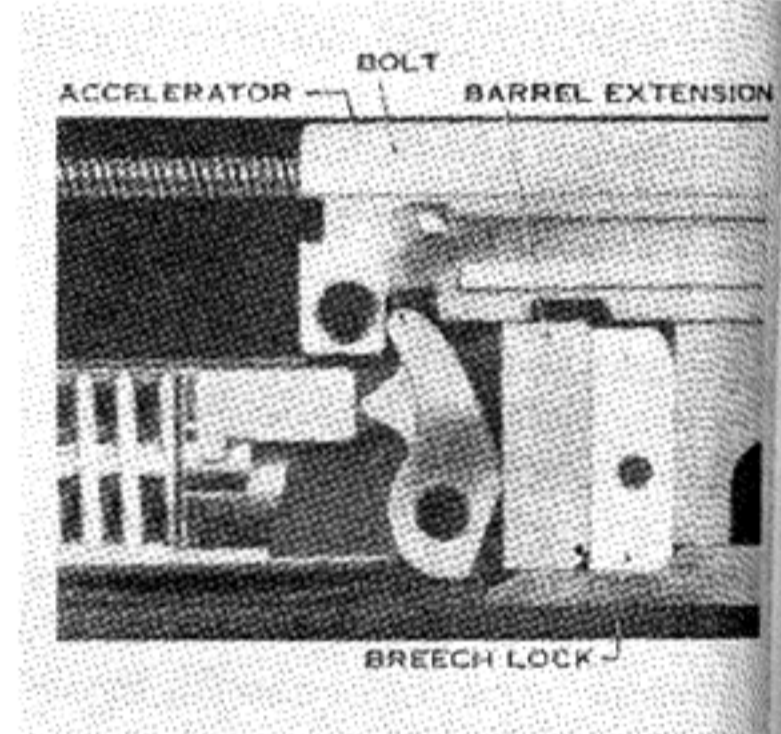
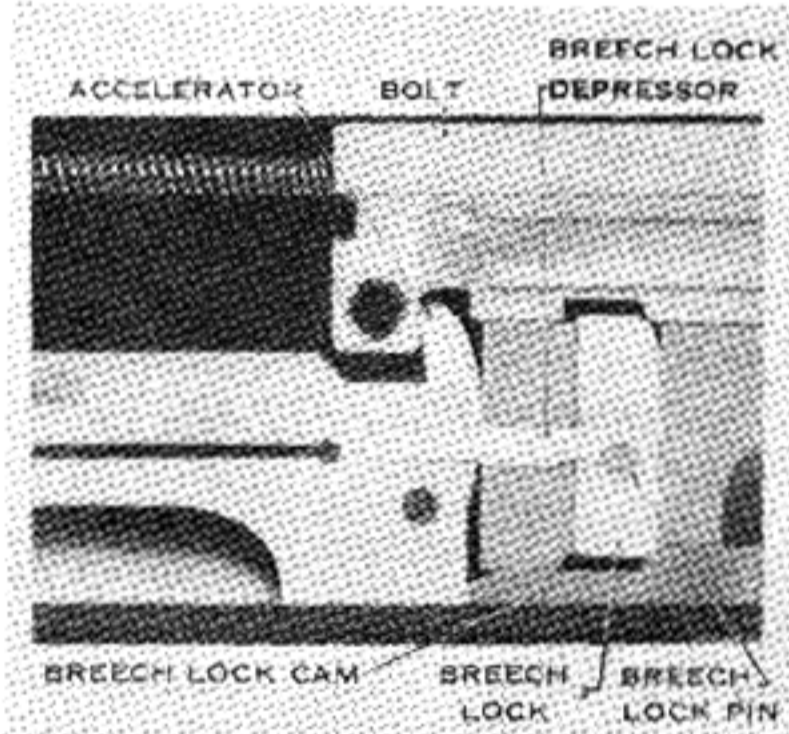
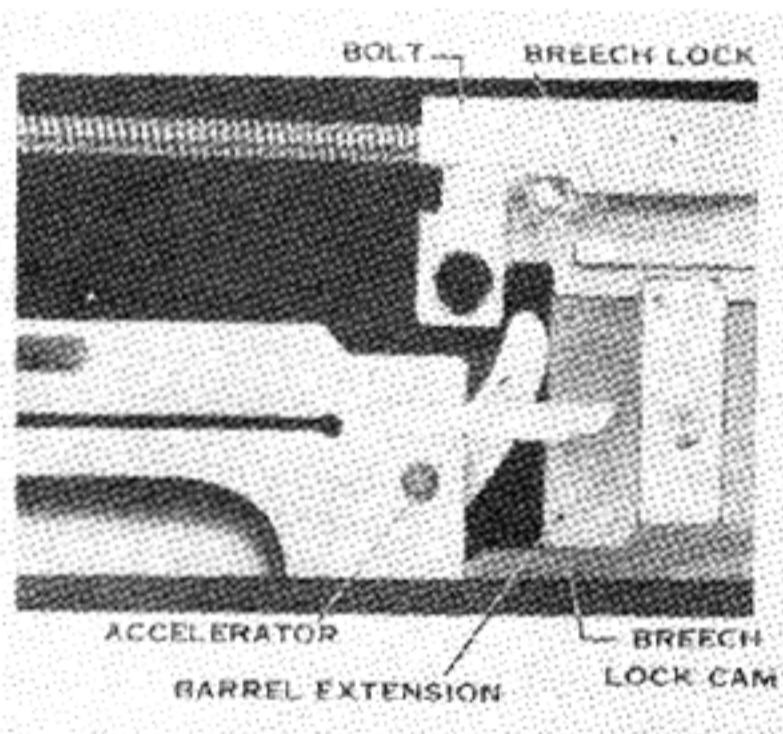

this initial motion, the bolt is supported securely against the base of the cartridge by the breech lock which rides up from the barrel extension into a notch in the underside of the bolt.

After a travel of about  $\frac{3}{4}$ " during which time the bullet has left the barrel, the breech lock is pushed back off its cam. It is forced down out of its locking notch on the under side of the bolt by the breech lock

depressors riding up and over the lock pin which passes through the breech lock and protrudes on either side. This action unlocks the bolt.

The barrel extension trips the accelerator up and to the rear on its pin. The tips of the accelerator striking the lower projection on the rear of the bolt accelerate its rearward travel. After a travel of about  $1\frac{1}{8}$ ", the

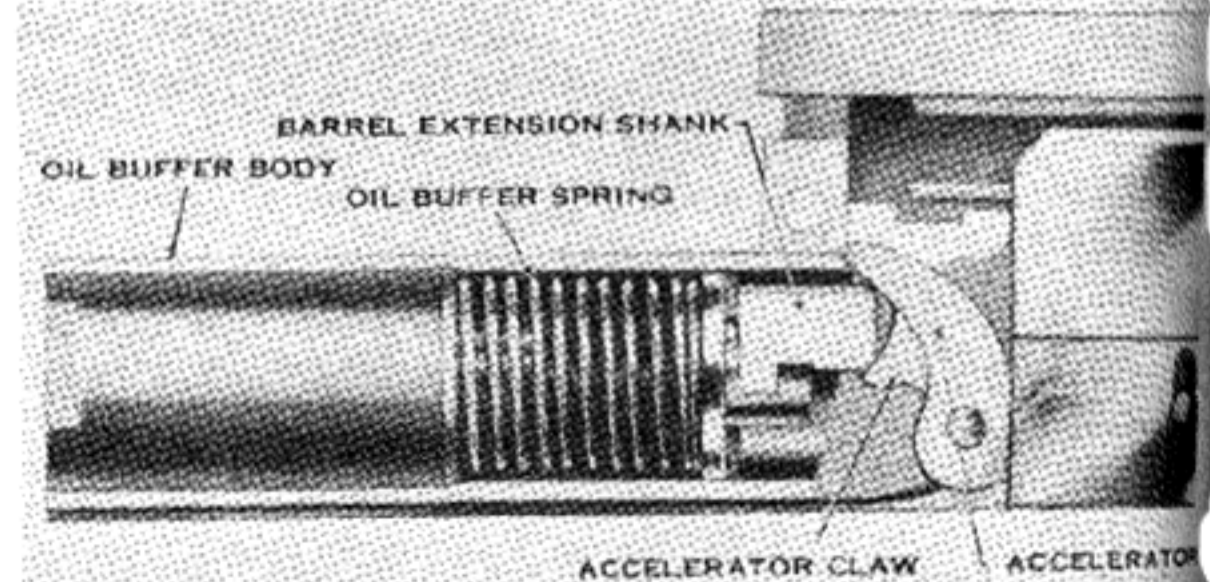
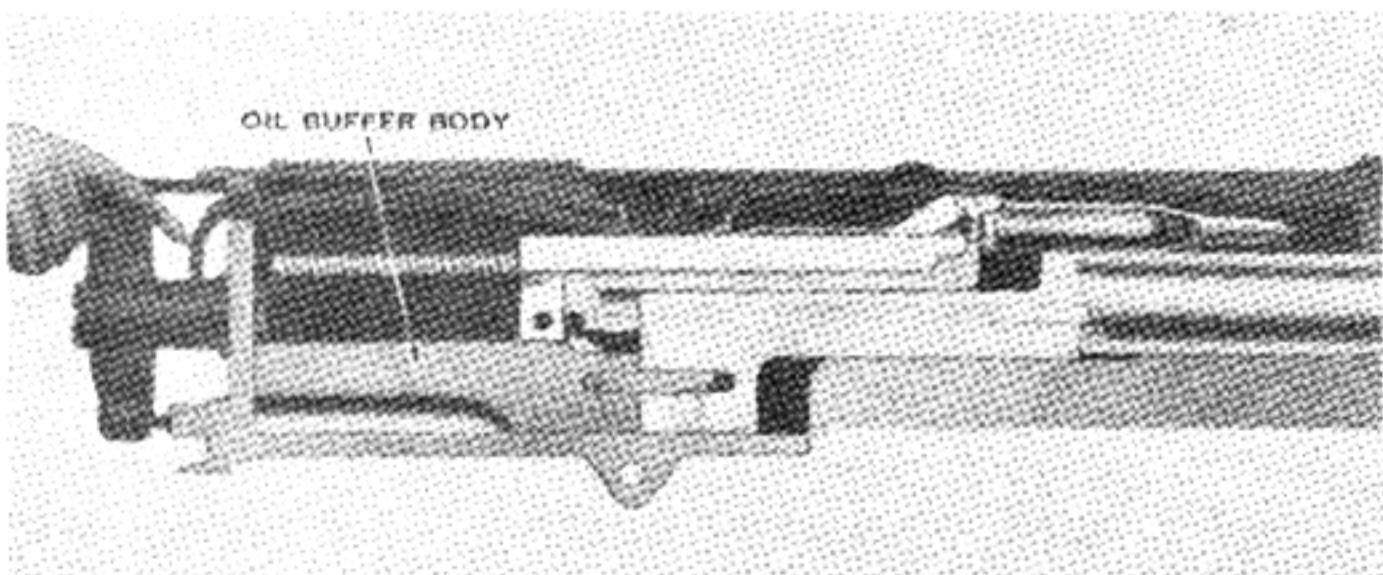

barrel and barrel extension have completed their rearward travel. They are stopped by the oil buffer body assembly, whose oil buffer spring has been compressed in the oil buffer body by the shank in the barrel ex-

tension. The flipped-up claws on the accelerator lock the spring in compressed position as they are moved against the shoulders of the barrel extension shank.



# U. S. BROWNING .50 M2 MACHINE GUN

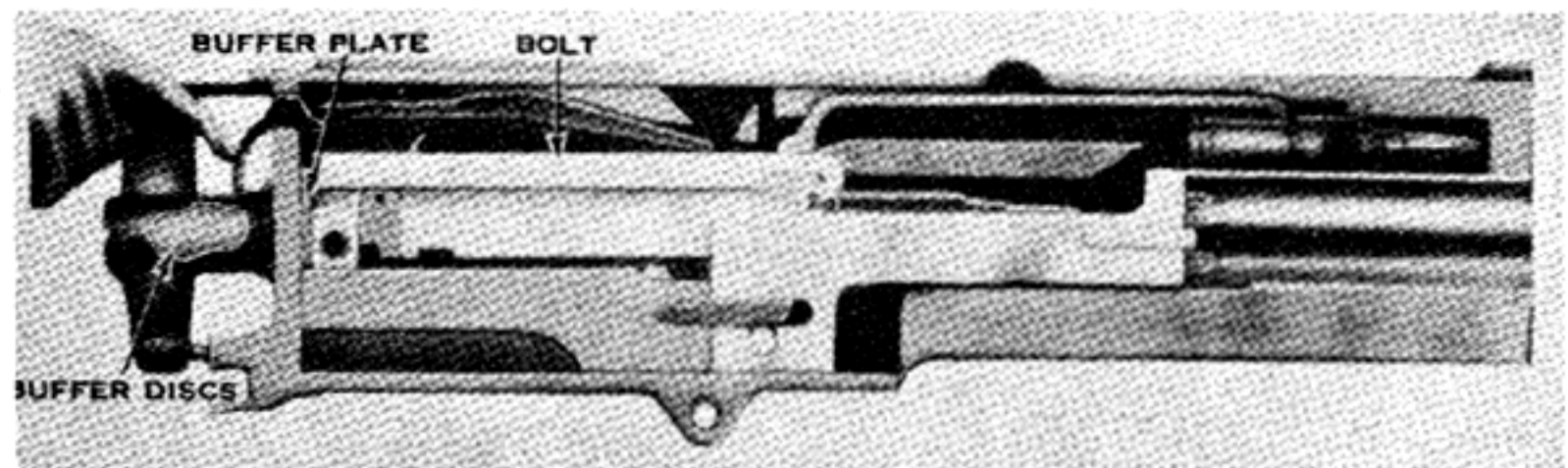
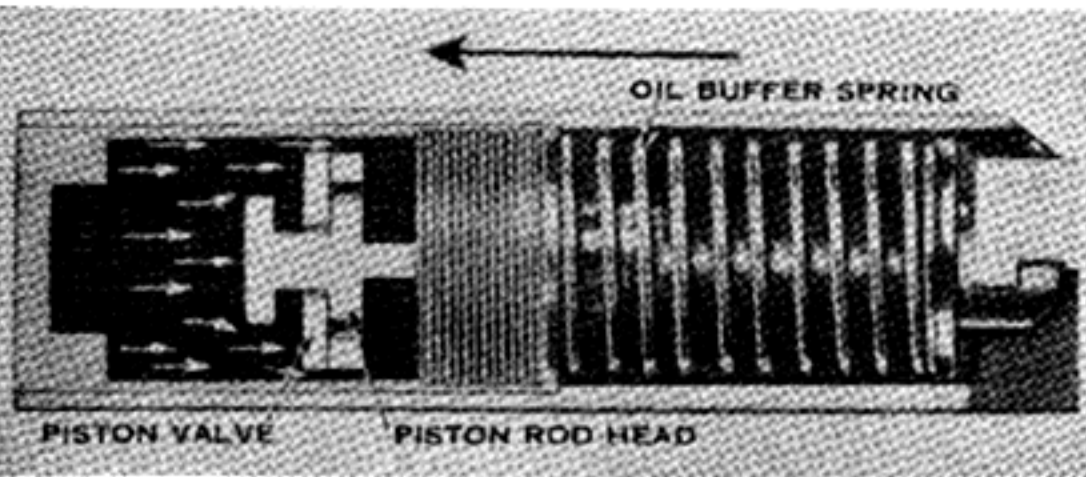

Meanwhile a piston rod head in the oil buffer assembly is forced from front to rear end of the oil buffer tube, and presses against oil in the tube to absorb the rearward shock of recoil until the oil escapes through the front side of the piston. This oil flow is through notches between the edge of the piston rod head and the oil buffer tube. This cushions the recoil and brings the

rearward motion to a complete stop when the recoiling functions have been completed.

As the bolt travels to the rear, the driving springs inside it are compressed and its rearward motion is stopped when the rear of the bolt strikes the buffer plate.

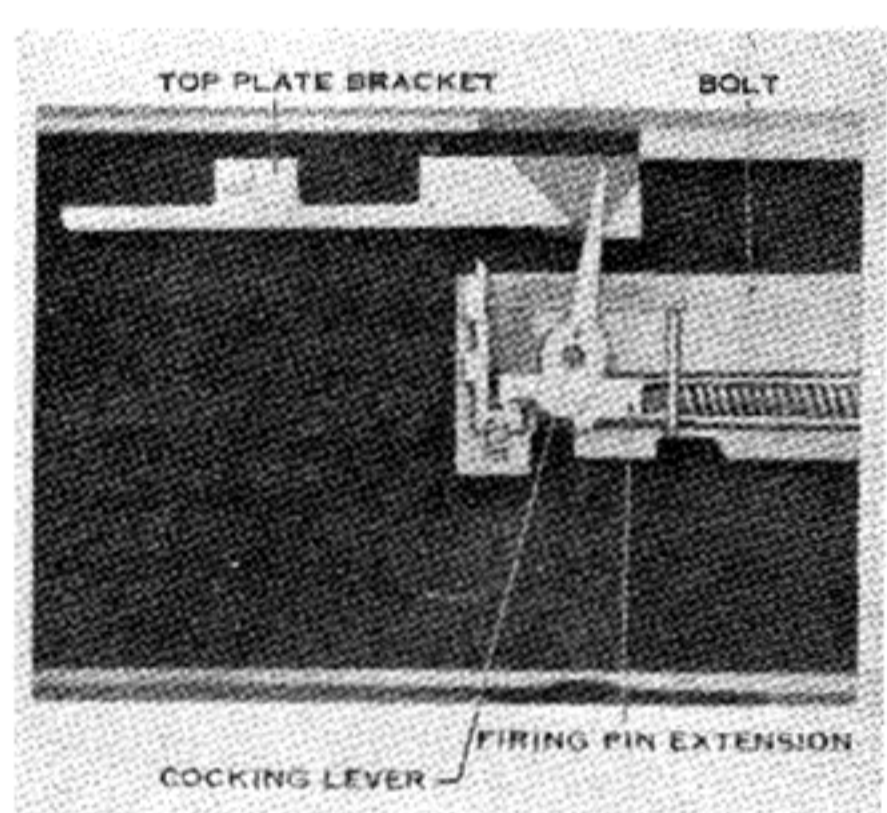
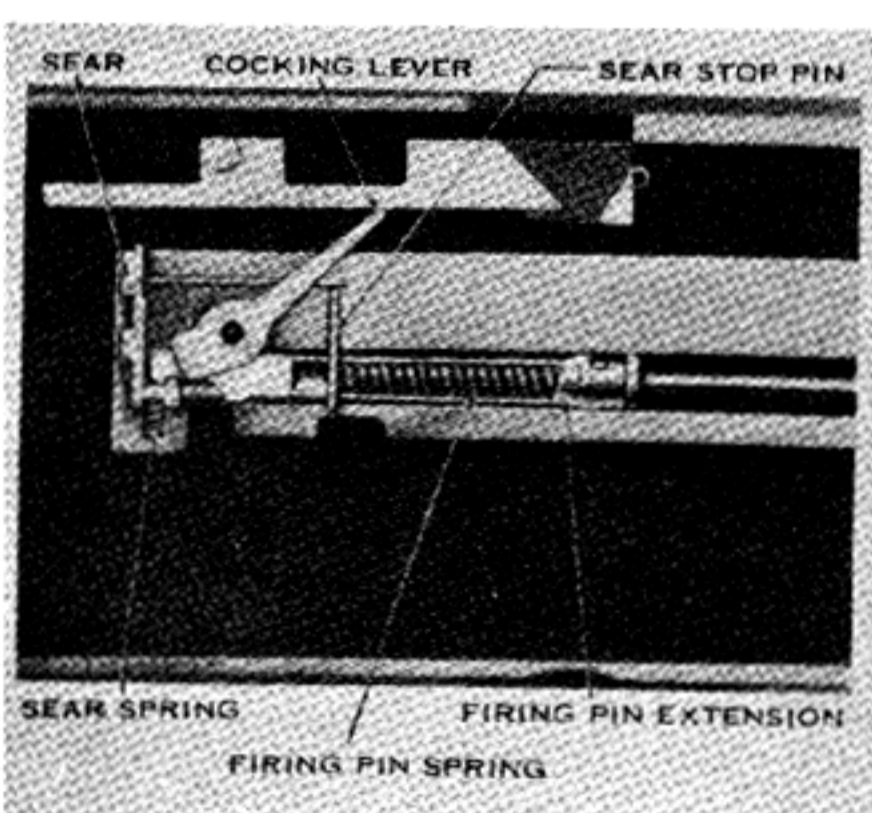
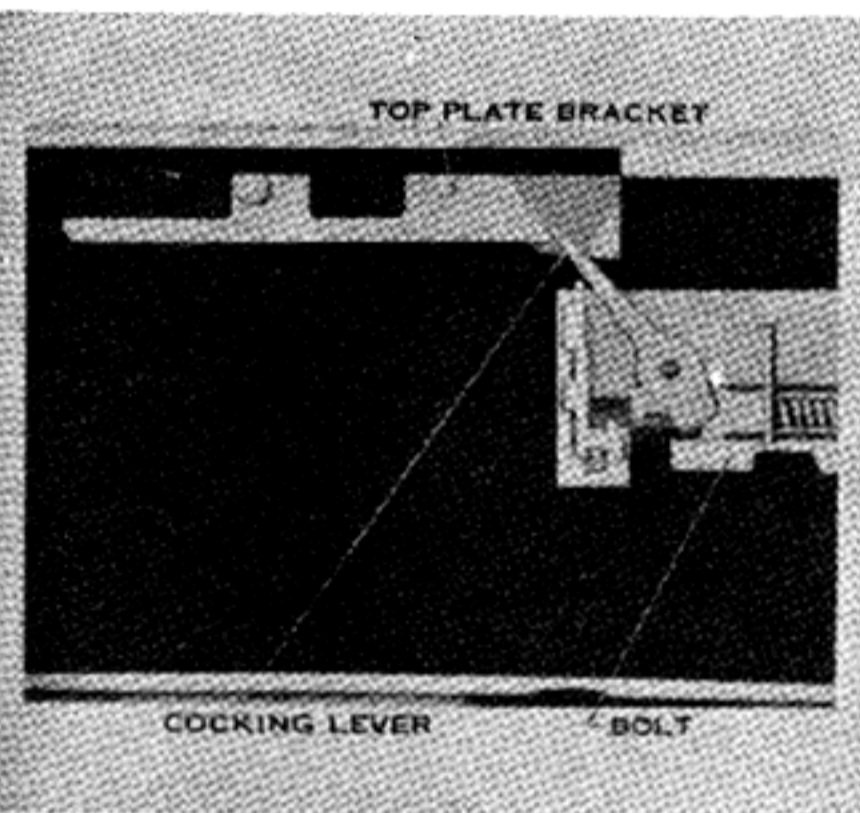

**Cocking Action:** The tip of the cocking lever protrudes through the top of the bolt where it lies in a V-slot in the top plate bracket. As the bolt starts to recoil, the tip of this cocking lever is pushed forward and its lower end is pivoted to force the firing extension rearward. This compresses the firing pin spring against the sear stop pin until the shoulder at the rear end of the firing

pin extension hooks over the notch in the bottom of the sear under pressure of the sear spring.

When the bolt goes forward after the completion of the rearward motion, the tip of the cocking lever enters the V-slot in the top plate bracket, thus pivoting the bottom of the cocking lever out of the path of the firing pin extension to release the firing pin.

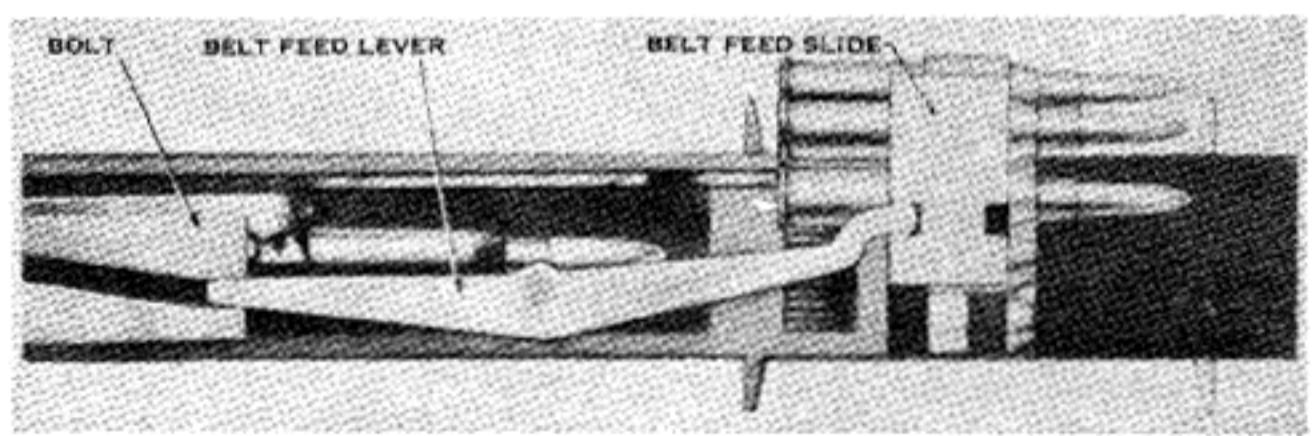
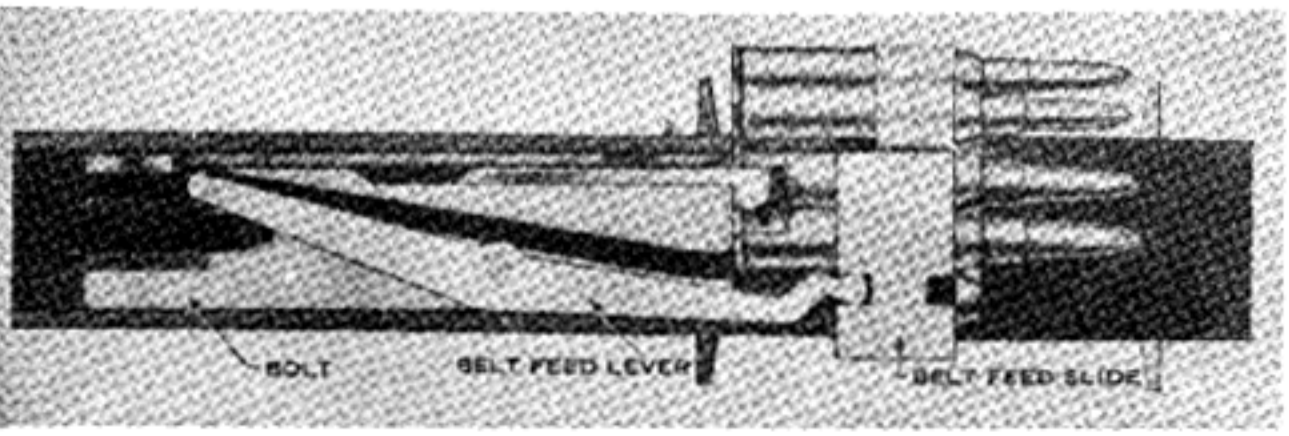

**Feeding During the Rearward Motion:** As the bolt moves to the rear, the stud at the rear of the belt feed lever is engaged in the diagonal groove on top of the bolt. This bolt stud thus serves to move the feed lever

which is pivoted near its center and carry the belt feed slide at the front end of the lever out the side of the gun where its spring snaps it down over the next cartridge in the ammunition belt.



# U. S. BROWNING .50 M2 MACHINE GUN

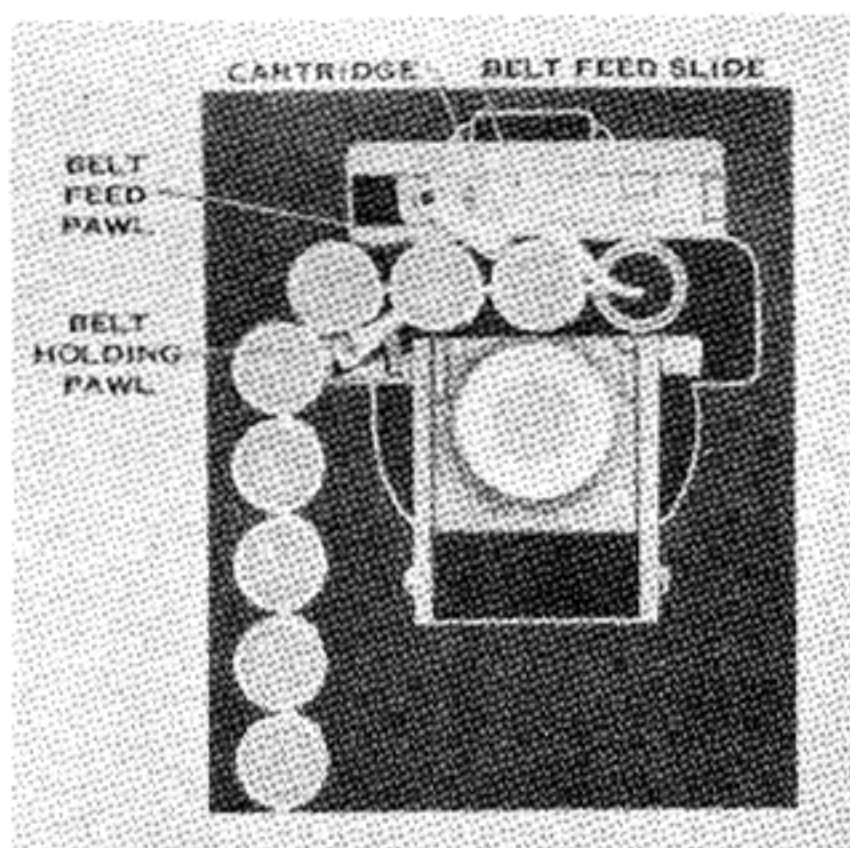

The belt is pulled into the gun by the belt feed pawl attached to the belt feed slide and rides over the next cartridge.

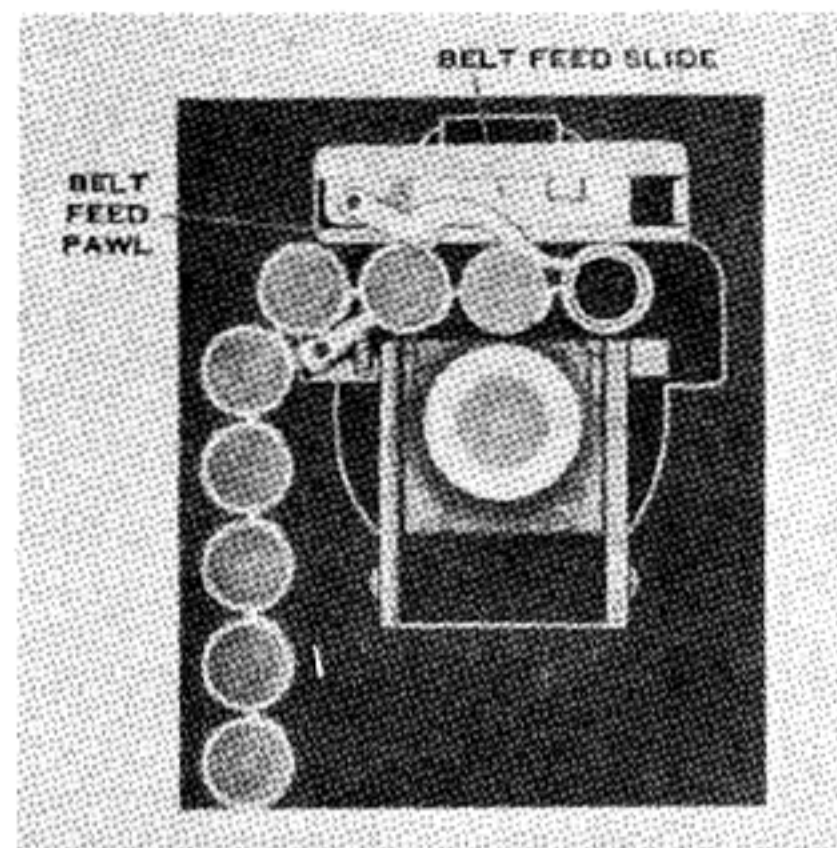

As the recoiling motion is completed, the belt feed slide has traveled far enough to permit the belt feed pawl to be snapped down by its spring behind the

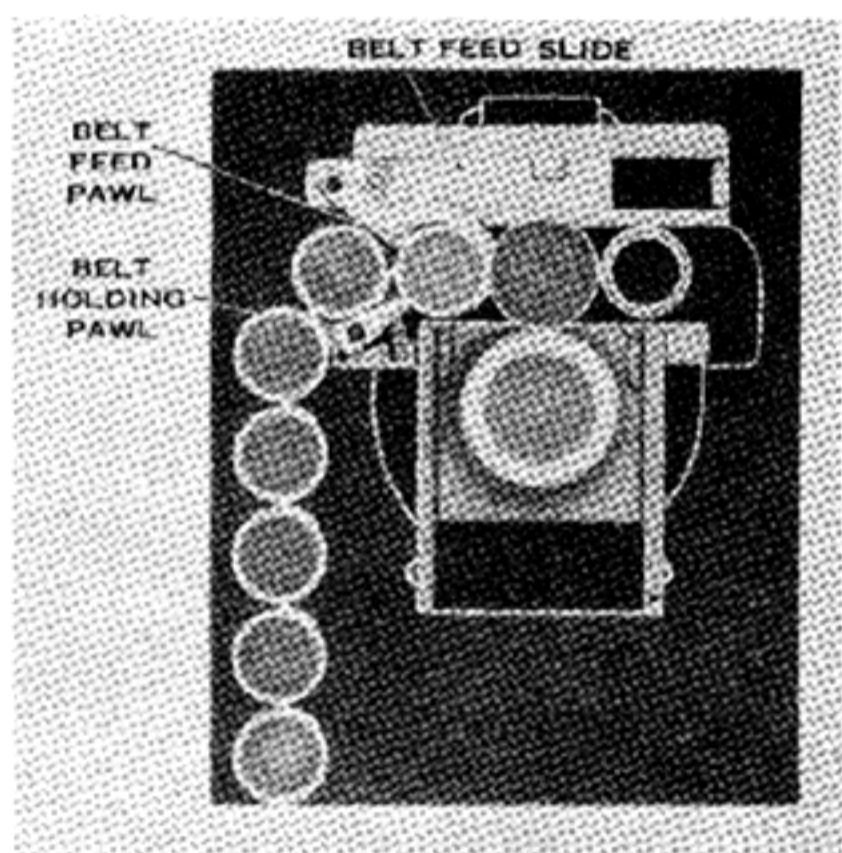

next cartridge, ready to pull the belt forward into the gun on the next motion.

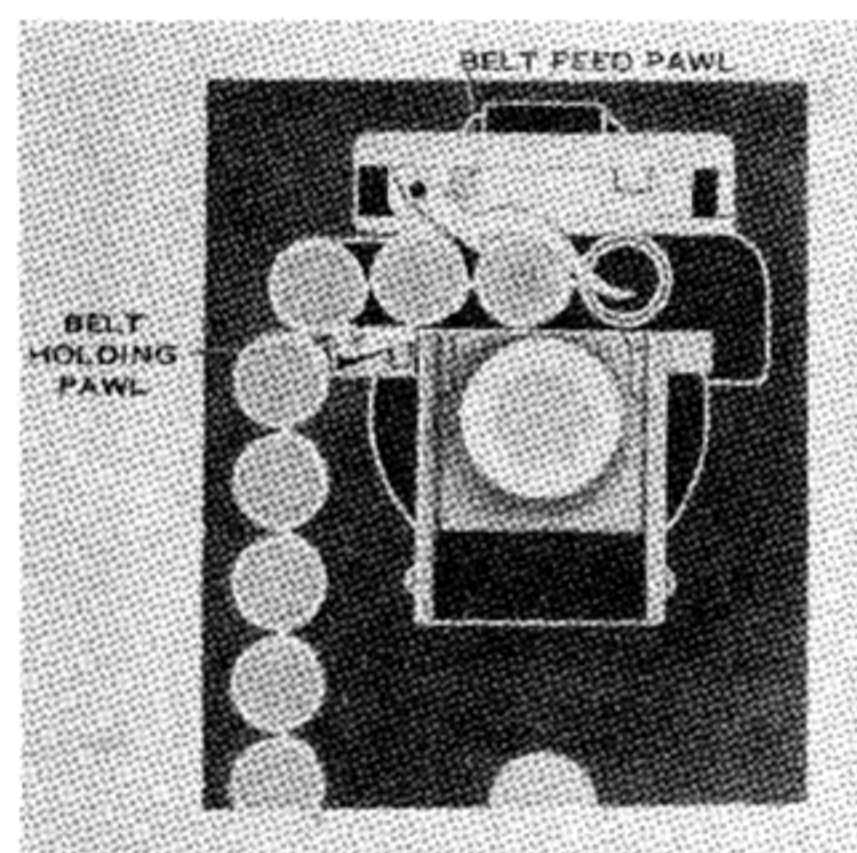

**Forward Feeding Motion:** As the bolt moves forward, the stud riding in its top pulls on the pivoted belt feed lever. The belt holding pawl is forced downwards as the cartridge is pulled over it and the belt holding pawl snaps up behind the next cartridge.

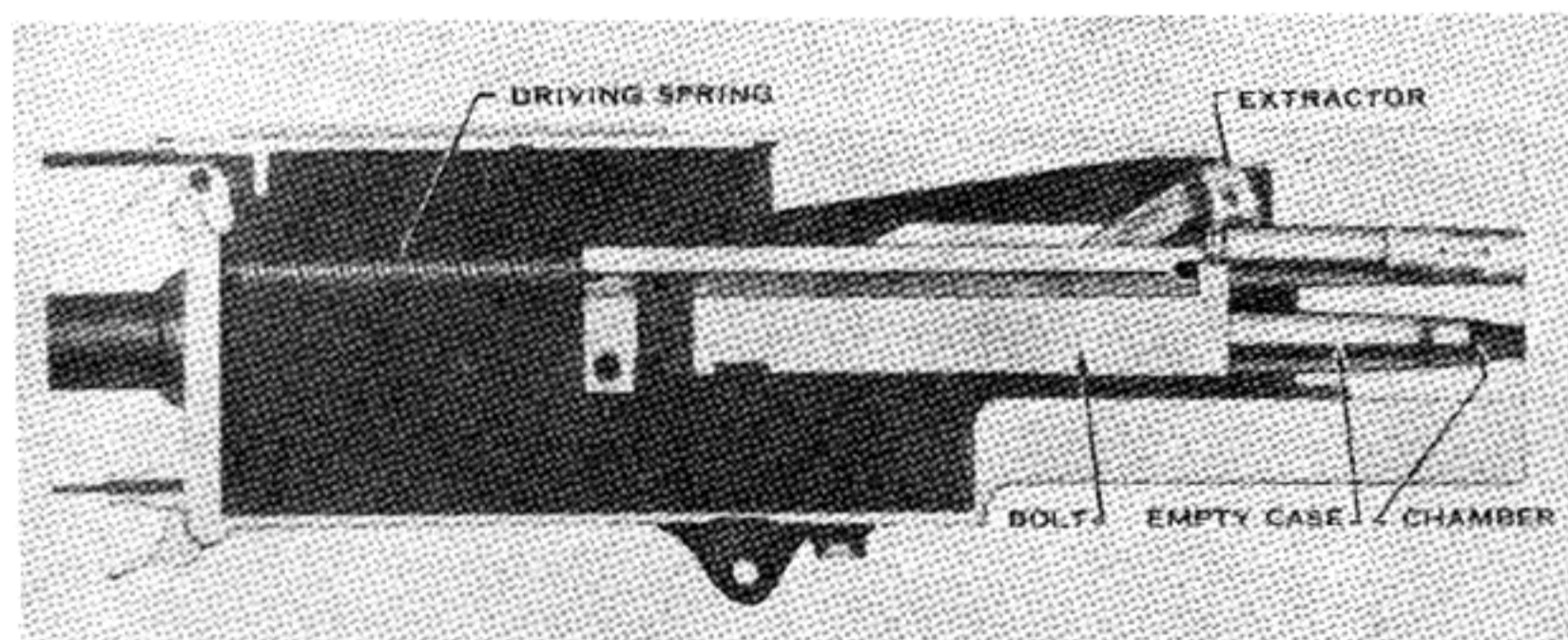

**Extraction and Ejection:** When the rearward motion starts, the extractor mounted in the side of the bolt and with its head above the bolt level snaps down into the cannellure of the cartridge in the belt; then draws the cartridge back out of the ammunition belt. The empty cartridge case is held in the T-slot in the front face of the bolt and the bolt withdraws it from the firing chamber.

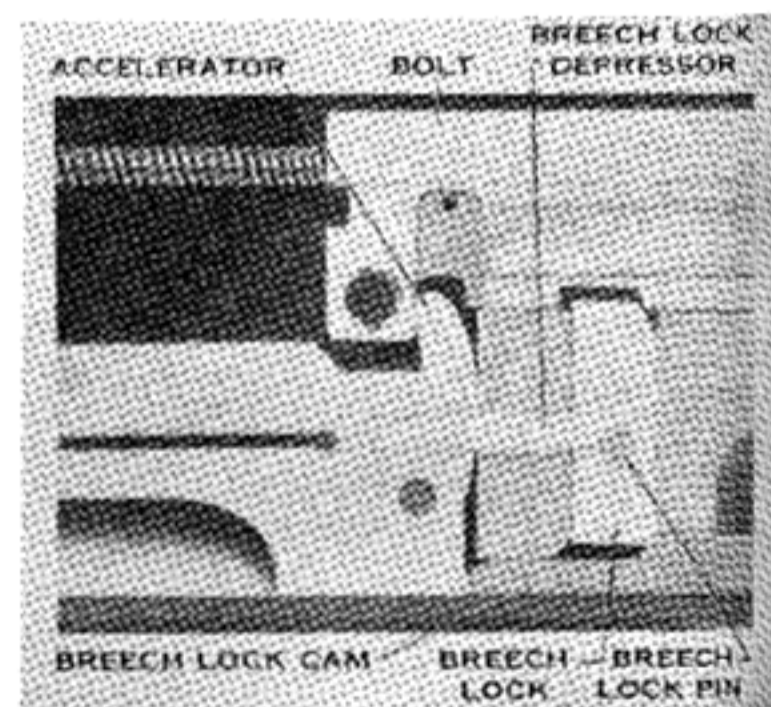

The top front edge of the breech lock and the front side of the notch in the bolt are beveled to start withdrawal of the empty cartridge case slowly to prevent the case from being torn apart by a sudden jerking motion. As the breech lock is unlatched, the bolt pulls away from the barrel and barrel extension easily enough to prevent rupturing the cartridge case.



# U. S. BROWNING .50 M2 MACHINE GUN

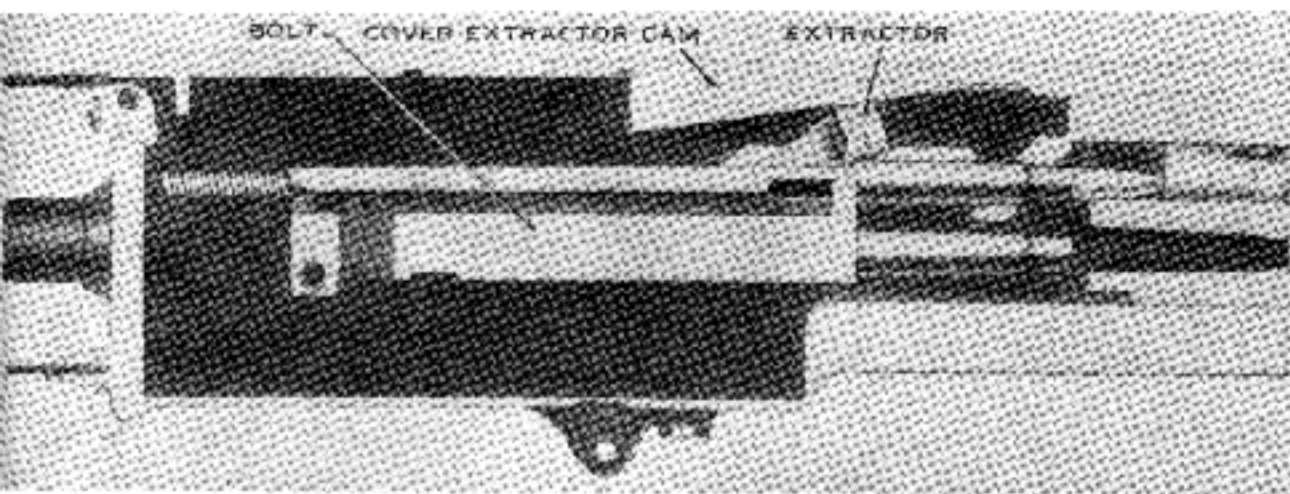

The cam on the inside of the cover forces the head of the extractor down, pushing the loaded cartridge into the mouth of the T-slot in the bolt. A lug on the side of the extractor rides against the top of the switch causing it to pivot downward at the rear; and as the recoiling motion comes to an end the lug on the ex-

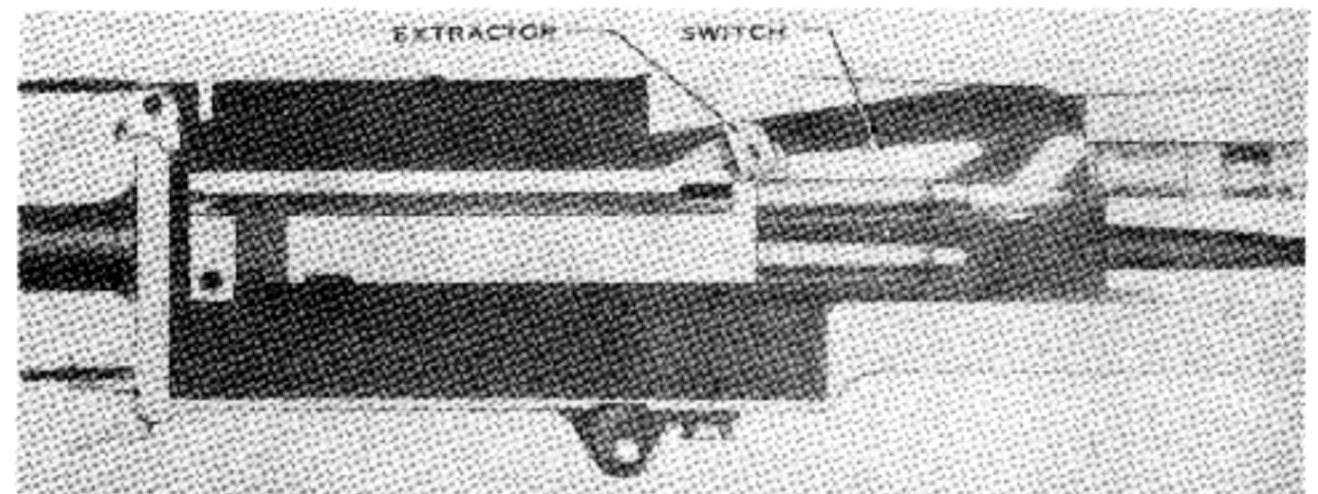

tractor overrides the end of this switch, permitting it to snap up into normal position.

During this movement the empty cartridge case drops down out of the T-slot and is expelled through the bottom of the gun.

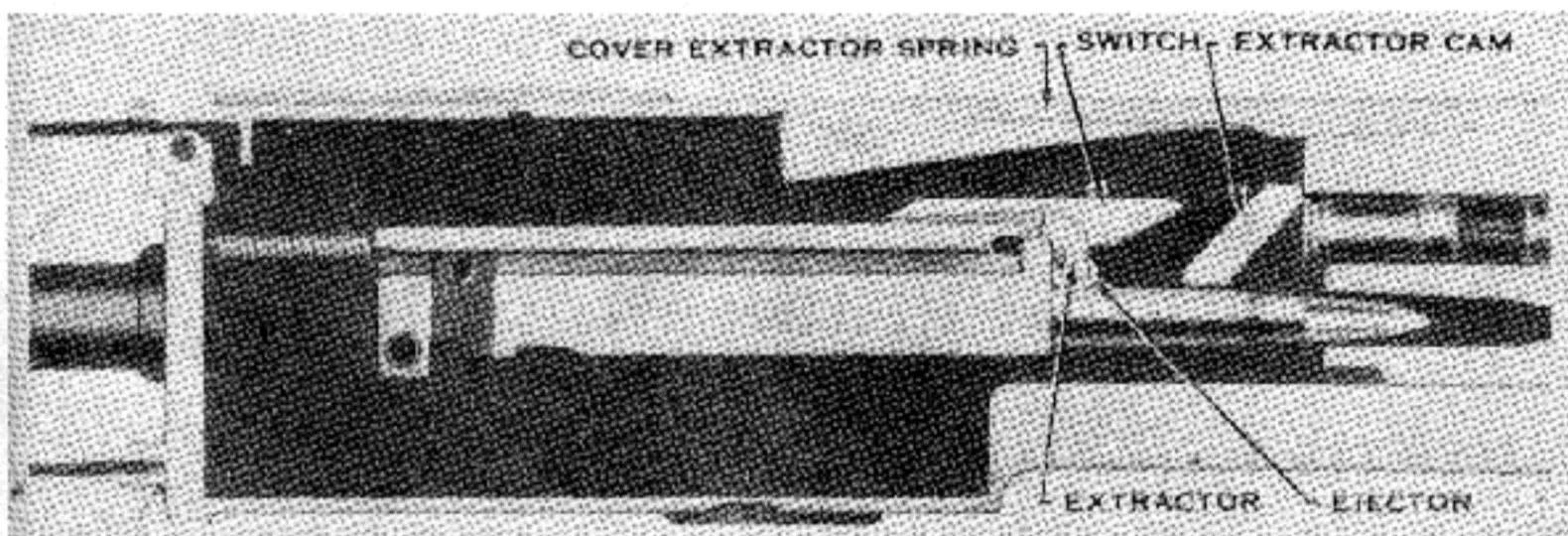

**Forward Motion of the Extractor:** As the bolt goes forward, the extractor lug riding under the switch forces the extractor further down, thus forcing out the empty cartridge case if it has not already dropped out of the gun. A pin in the bolt limits the travel of the extractor and the cartridge, assisted by the ejector, is fed directly into the firing chamber.

When the cartridge is nearly chambered, the extractor rides up its cam compressing the cover extractor spring and is snapped into the cannellure of the next cartridge.

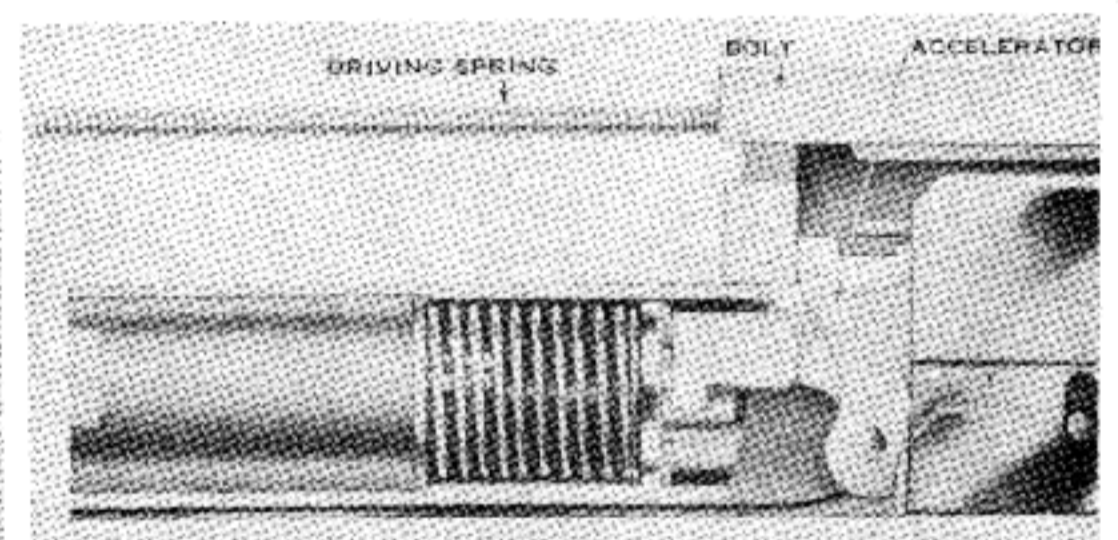

**Further Action During Forward Movement:** After the recoiling motion has been completed, the compressed driving spring and the compressed buffer disc force the bolt forward. The bolt travels about 5", when the projection on its bottom strikes the tips of the accelerator, rolling the accelerator forward on its pin.

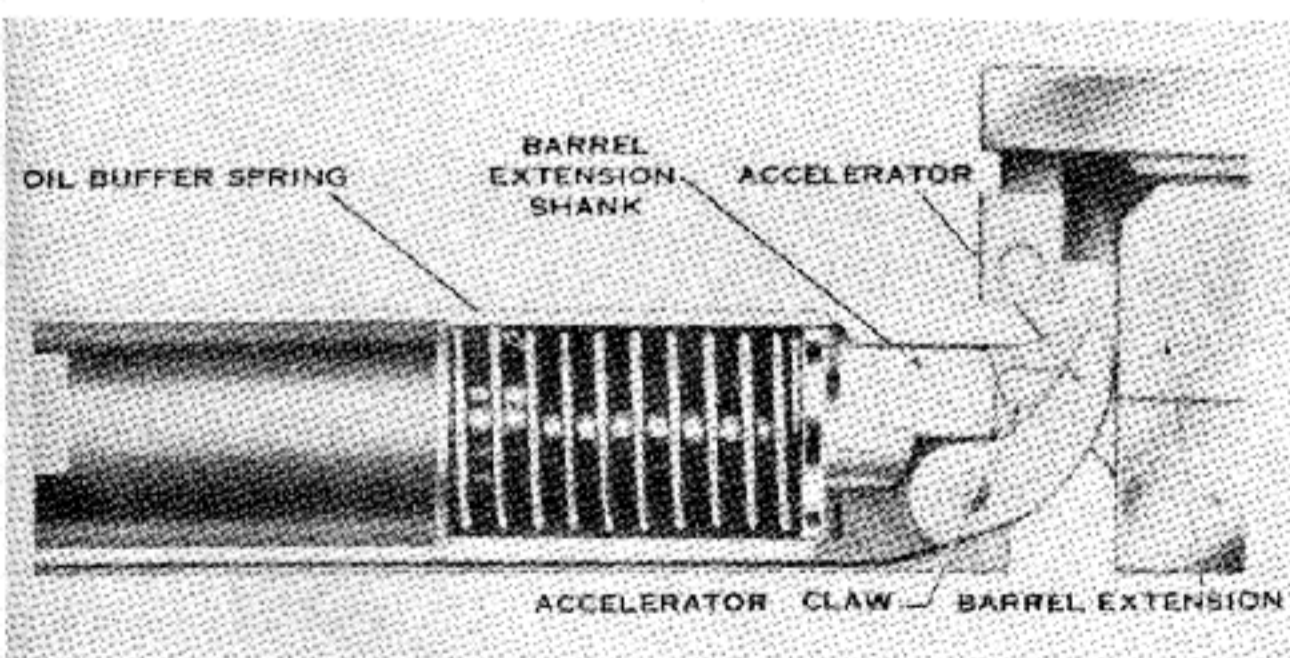

The accelerator claws are pulled away from the shoulder of the barrel extension shank, releasing the oil buffer spring. This spring now shoves the barrel extension on the barrel forward.

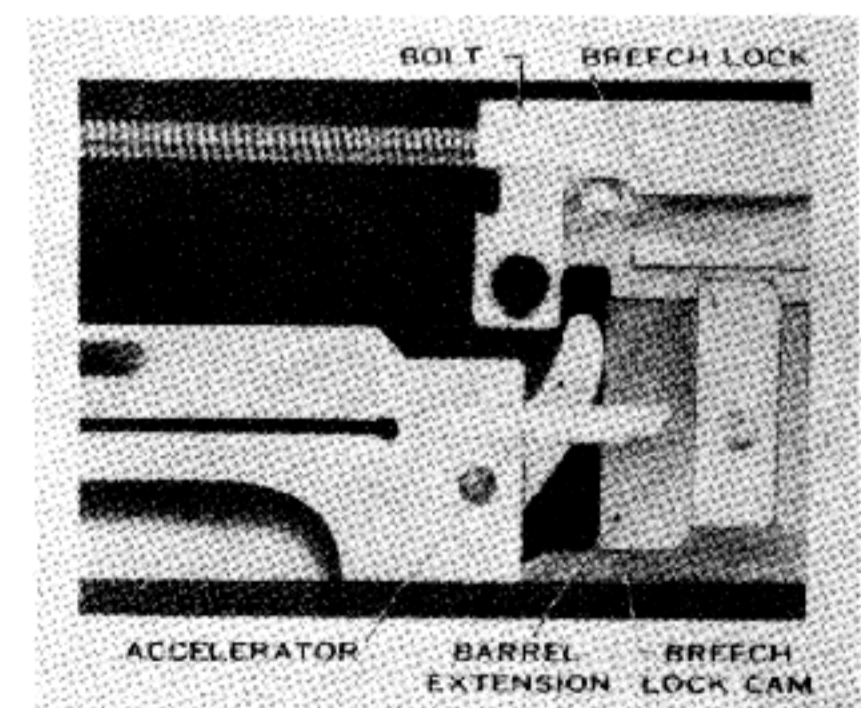

As the barrel extension goes forward, the breech lock strikes its cam and is forced upward on its pin. At that moment the bolt has reached the position where the notch on its underside is directly above the breech lock; and the breech lock rides up its cam and engages in this slot in the underside of the bolt. The bolt is locked to the breech end of the barrel just before the recoiling section reaches firing position.



# U. S. BROWNING .50 M2 MACHINE GUN

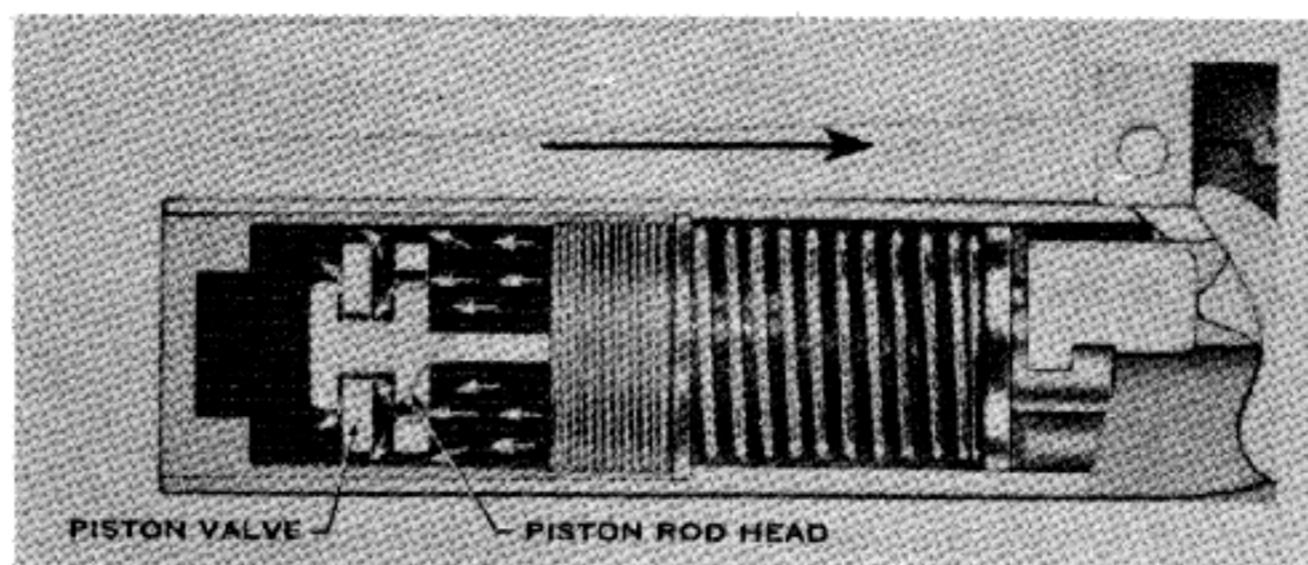

**Oil Buffer:** As the action moves forward additional openings for oil flow are provided in the piston rod head of the oil buffer assembly. The piston valve is forced away from the rod head as the parts move forward to uncover these openings. Thus the oil is permitted to escape freely from the opening in the center of the piston valve as well as at the edge of the valve near the tube wall, and so prepare it for the rearward motion.

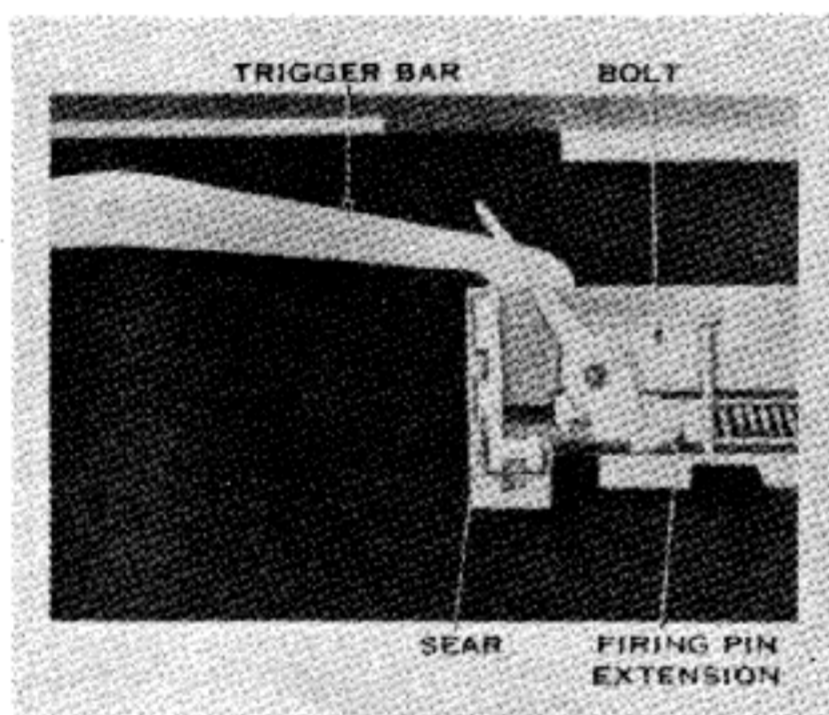

**Automatic Fire:** If the trigger is pressed and held down, the sear is depressed as its tip is pressed against the cam surface of the trigger bar by the forward motion of the bolt just before it completes its forward motion. The notch in the bottom of the sear releases the firing pin extension and firing pin, automatically firing the cartridge as the forward motion is completed and continuing the action as long as the trigger is held and cartridges are fed into the gun.

**Tripod Mount:** A tripod mount is provided for the Browning machine gun caliber 50 H.B. M2. The tripod assembly weighs about 40½ pounds, while the pintle and elevating mechanism assemblies weigh another 4 pounds. In considering weight of the weapon for field use, these facts must be taken in connection with the weight of the gun which is about 84 pounds.

**Oil Buffer Adjustment:** The oil buffer provides a method of regulating the speed of fire of this gun. Fire rate may be regulated by turning the oil buffer tube the required number of clicks. Turning the buffer tube to the left opens the oil buffer and permits oil to pass through the larger ports, increasing the rate of fire. Turning the buffer tube to the right tightens up the oil buffer allowing it to absorb more recoil and reduce the rate of fire. This tube may be turned by inserting a screw driver in the slot in the rear of the buffer tube.



# THE ROCKET LAUNCHER, A. T., M1 (The Bazooka)



U. S. Signal Corps Photo

The Rocket Launcher, or Bazooka, as it is more familiarly known, is a brilliant American adaptation of a principle which is as old as explosives. The Germans and the Russians have been using rocket principle weapons for several years now. However, the Bazooka is the first efficient use of the rocket enabling it to be utilized in ordinary infantry company tactics. This article deals primarily with the Rocket Launcher itself. As photographs received from Europe prove that the Germans are in possession of Bazookas captured by them from the Russians to whom they were lease-lent, instructions on loading and firing this weapon do not require military secrecy.

The projectile itself will not be dealt with except in general terms.

**General Description:** The rocket launcher, A.T.-M1, is a shoulder weapon consisting of a metal tube 54" long which is open at both ends. It will generally be fired by a 2-man team. The diameter of the bore is 2.36". A front sight is welded to the barrel near the muzzle. It is so constructed that the weapon may be aimed from either the left side or the right side. This sight is equipped with 4 studs used for aiming at ranges of 100, 200, 300 and 400 yards. The top stud is the 100 yard one.

The rear sight is placed about 15" from the muzzle and is provided with a turning arm which permits aiming from either the left or the right shoulder. The sight base itself is welded to the barrel and is fitted with a device to hold the sight in desired position. The square notch on the rear sight arm must be lined up with the proper stud on the front sight for the range at which the

Rocket Launcher is firing.

Two hand grips are welded to the underside of the tube. The forward one is about 8" from the end of the muzzle and is provided entirely for support of the weapon. The rear one, on the other hand carries the trigger mechanism.

The rocket is ignited by electricity, and hence the rear grip has not only the trigger and trigger spring, but also two contact switches which are actuated when the trigger is pressed.

To the rear of the trigger mechanism is the wooden shoulder stock, on the bottom of which is a hinged plate covering a compartment in which are stored two small dry batteries, one of which is connected to the electrical circuit, and the second of which is a spare. Also in the stock is an electric lamp which acts as a circuit tester, lighting up whenever the trigger is squeezed. This acts as a safety.

To the rear of the shoulder stock on top of the tube is the housing in which is the contactor mechanism. At its rear is a lever which may be pushed down to make the weapon safe, or up to prepare it for firing.

At the extreme rear of the tube is the tail latch which projects over the rear opening.

The breech guard projects rearward from the launcher tube to protect it from damage when its rear end is rested on the ground. A spring metal tube around the launcher tube itself just above the stock, permits circulation of air between the barrel and the guard to keep the face of the firer from being burned by the heat of the launcher tube.



# THE ROCKET LAUNCHER, A. T., M1 (The Bazooka)

## LOADING AND FIRING

1. Examine contactor lever at the rear of the housing on top of the tube. Set it for the safe position.

2. Push down the front end of the tail latch with the right hand; this will permit the rocket to be inserted head first when held by its fins in the left hand.

3. Remove safety pin from rocket and let the string, to which the pin is fixed, dangle over the back end of the fin. Push rocket into tube until a notch on the fin is caught by the tail latch yoke and held.

4. Jerk the string to pull out the plug, then push the contactor lever to the fire position and notify the firer that the launcher is ready.

5. The loader must move out of line of the rear of the launcher. While there is no recoil from this weapon, there is a terrific back blast of escaping gases as the rocket propulsion charge driving the rocket down the tube escapes by back blast out the open rear end.

The loader can be very seriously burned if he stays behind or near the rear end of the launcher during firing.

**Firing the Bazooka:** 1. The firer must test the Bazooka before permitting the weapon to be loaded. This is done by pressing the trigger and watching the light bulb. If it lights, the circuit is complete and the weapon will fire. The firer must judge the traveling speed of any moving objects at which he is to shoot as well as the effects of any winds which may be prevailing at the time of firing. When the sights are lined up on the target, the trigger is pressed.

2. Under normal conditions the charge which propels the rocket and which is set off electrically when the trigger is pressed, will burn up completely before the rocket leaves the muzzle. However in cold weather the powder burns somewhat more slowly; and the firer should wear helmet and mask.

## THE ROCKET

The Rocket itself weighs about 3½ lbs. and is about 21" long. It functions on the age old principle of the simple skyrocket. The head carries a charge of high explosive which is fired on contact. Behind it is a powder tube containing the charge which drives the rocket ahead; and behind it are tail fins which guide the Rocket in its flight. When the Rocket is in the gun the safety plug removed, pressing the trigger hooks up an electric circuit from the battery which ignites the propelling charge. Since gases are able to escape through

the rear of the tube while most of the force pushes forward to drive the projectile out the muzzle of the tube, the weapon fires without recoil. This principle permits the use of very sensitive high explosives. The force of this explosive may be gauged by the stories from the battle front telling of German armored units surrendering when trees and building near them were struck by Bazooka projectiles. Tank commanders were under the impression that 155 m/m guns were firing at them at close range.



U. S. Signal Corps Photo



# NOTES ON OPERATING PRINCIPLES AND HOLSTERS

## THE AUTOMATIC PISTOL-I PRINCIPLE

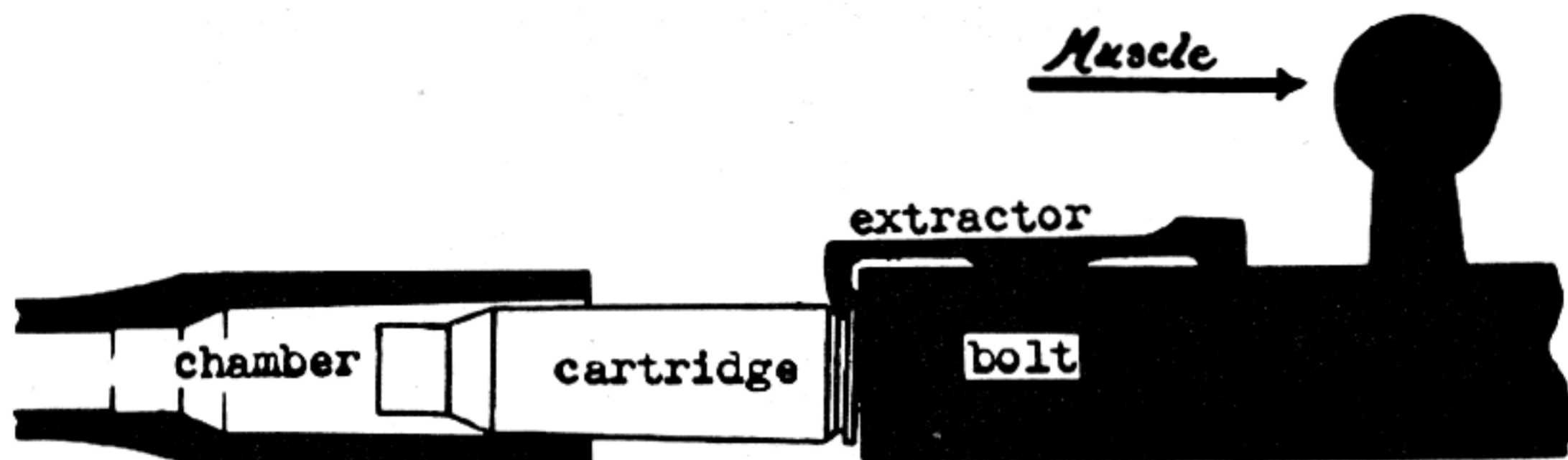

BOLT ACTION RIFLE

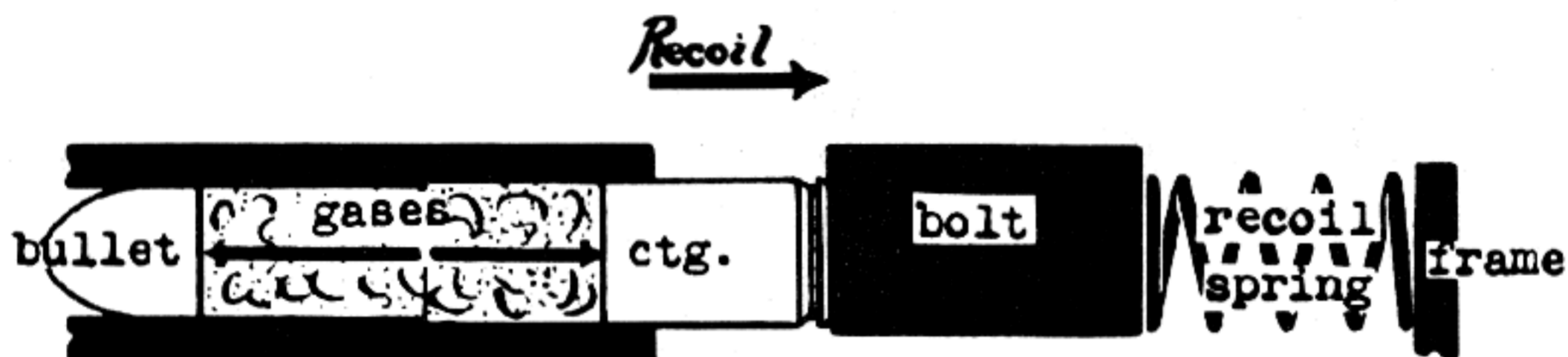

AUTOMATIC PISTOL

## TYPES OF ACTIONS

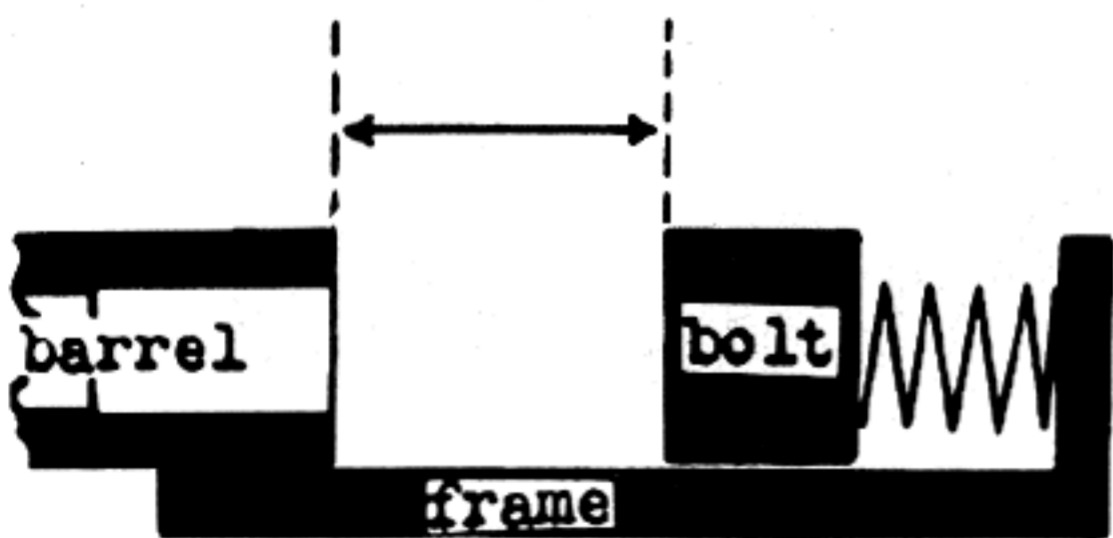

BLOW-BACK

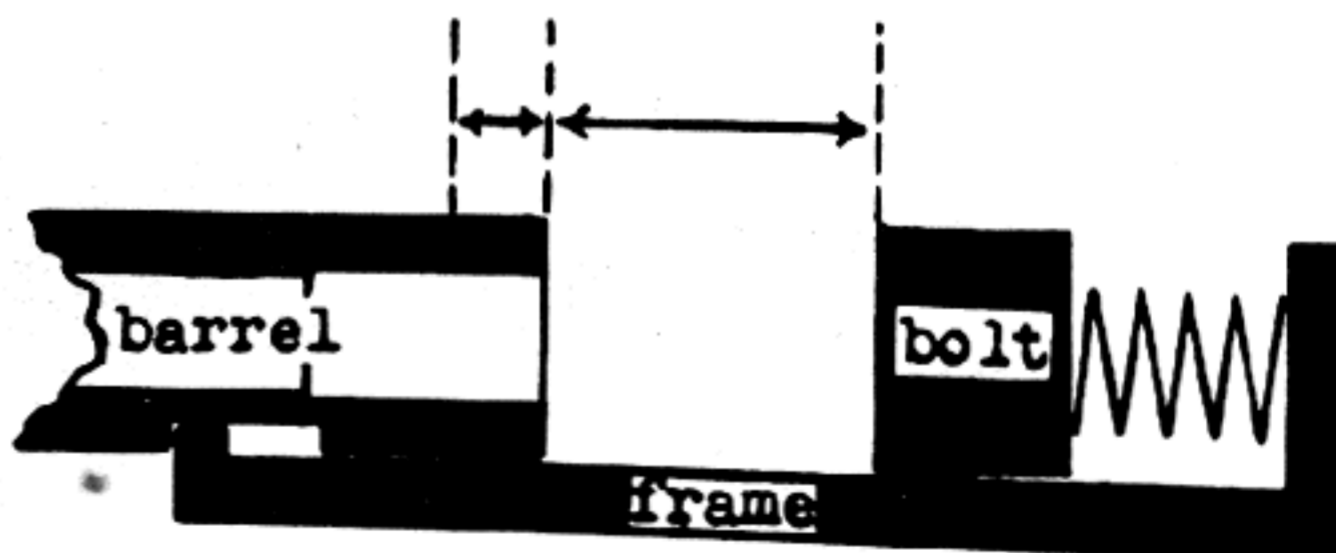

RECOIL



# NOTES ON OPERATING PRINCIPLES AND HOLSTERS

## THE AUTOMATIC PISTOL-II DETAILS

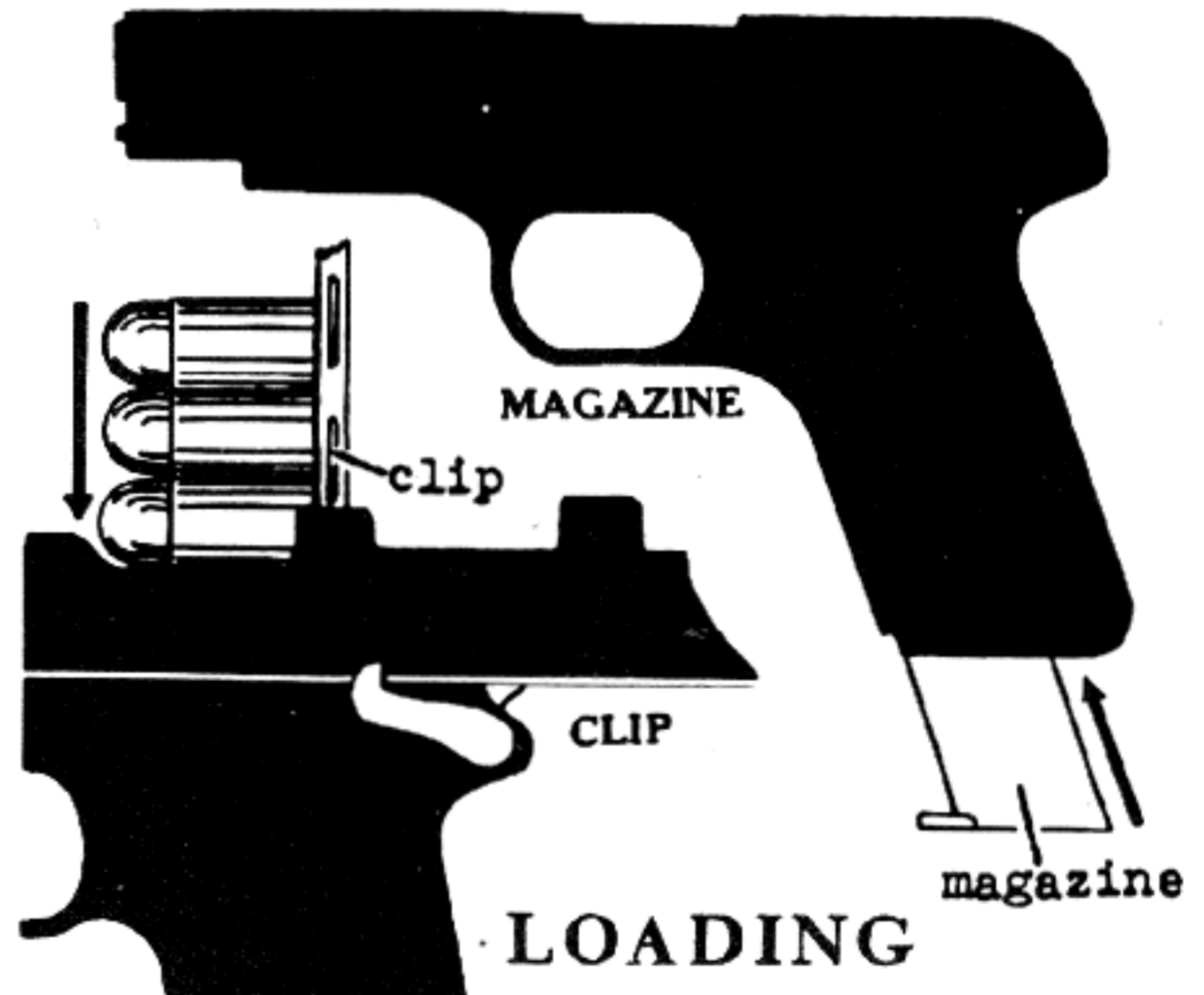
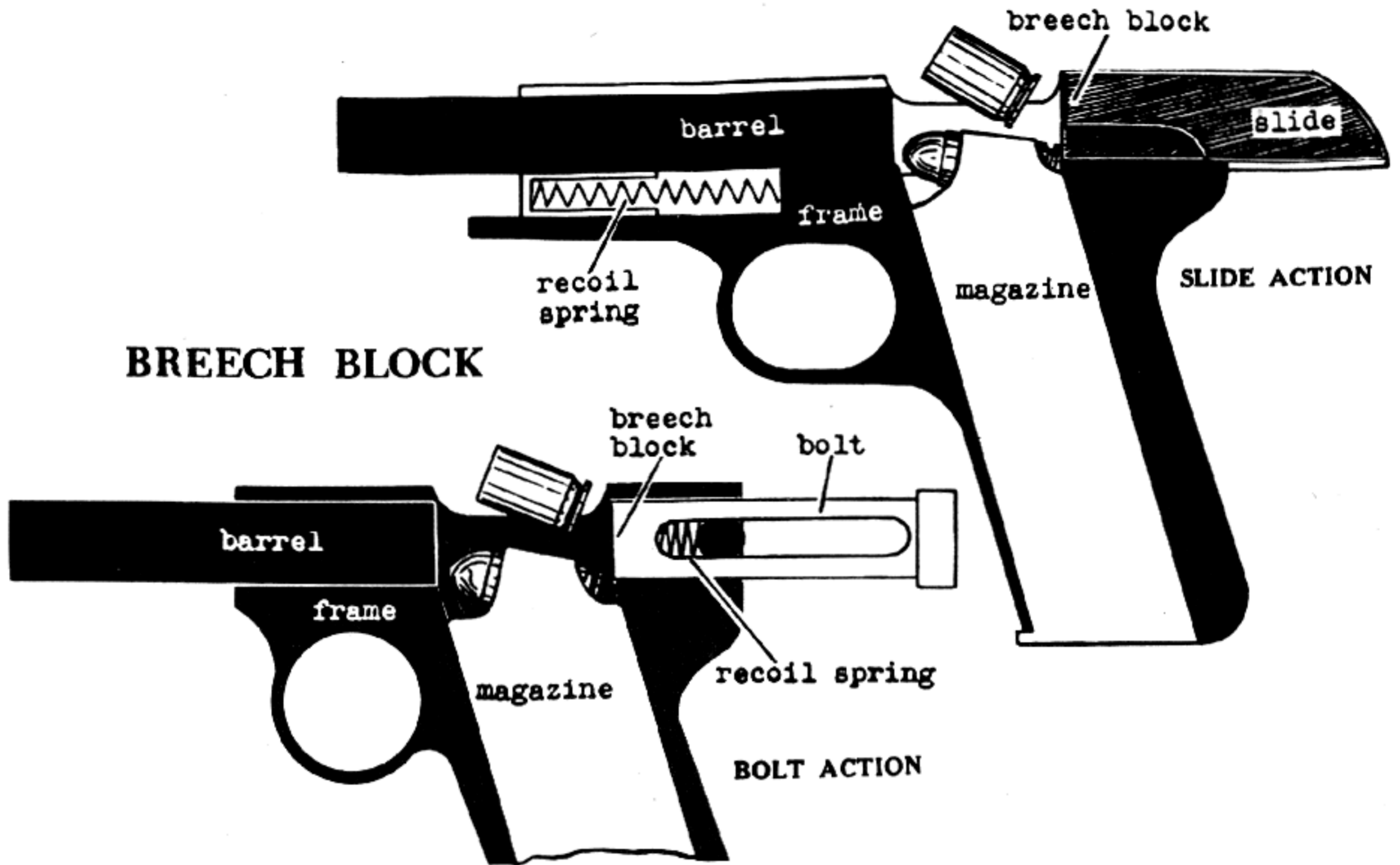



# NOTES ON OPERATING PRINCIPLES AND HOLSTERS

## THE REVOLVER

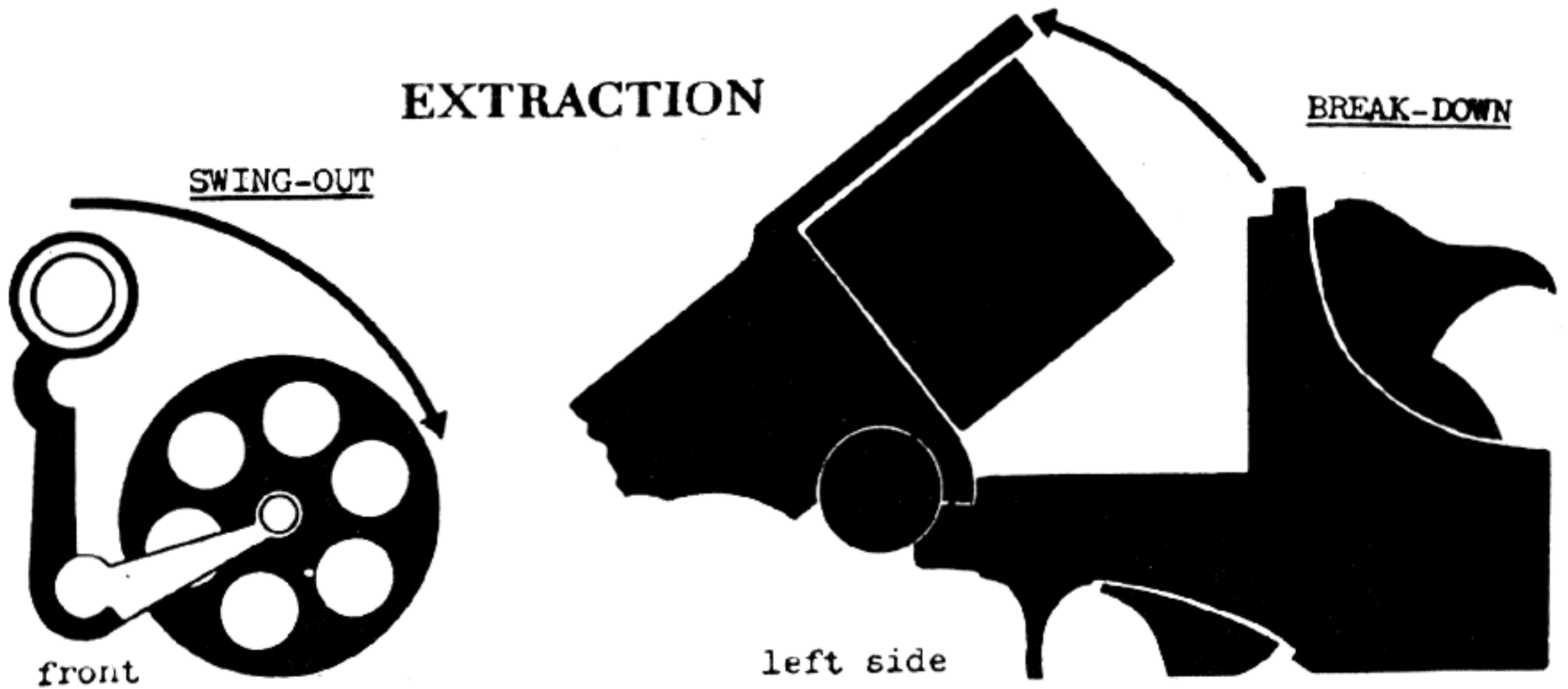
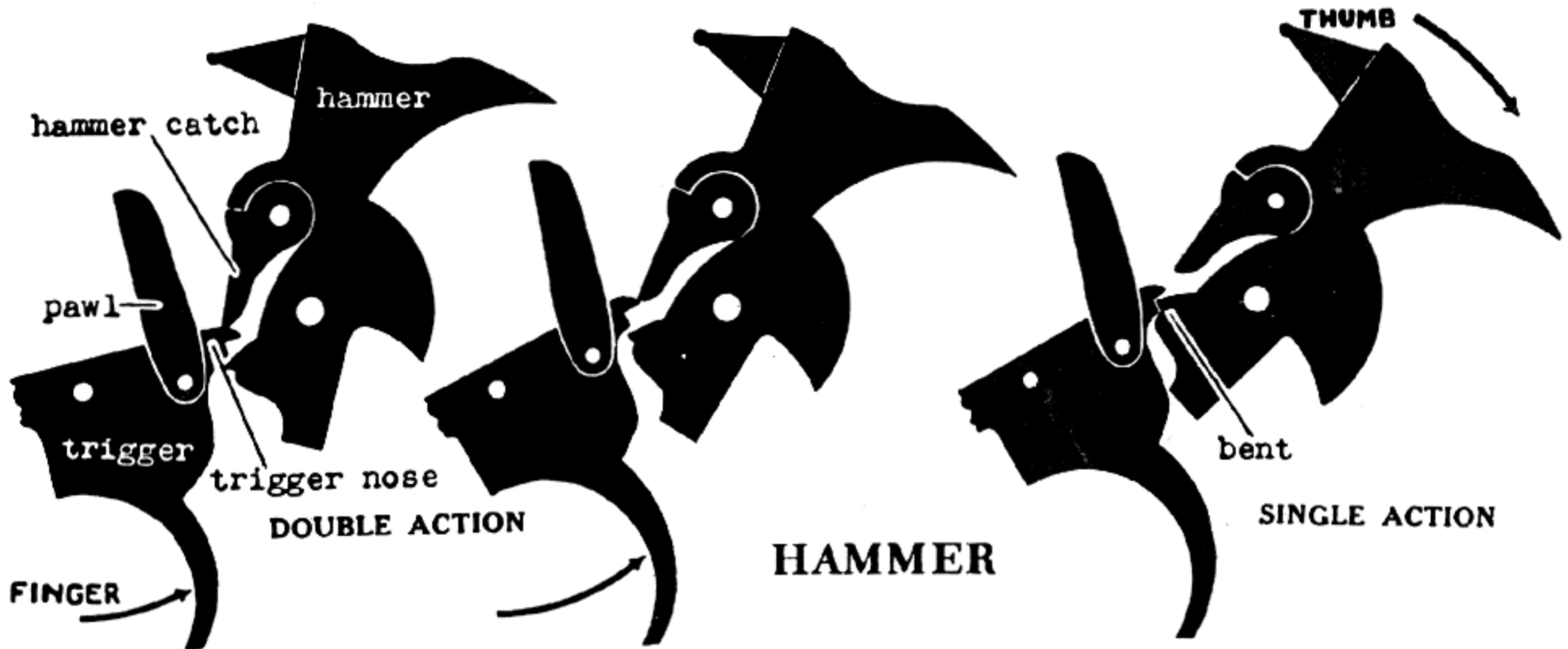
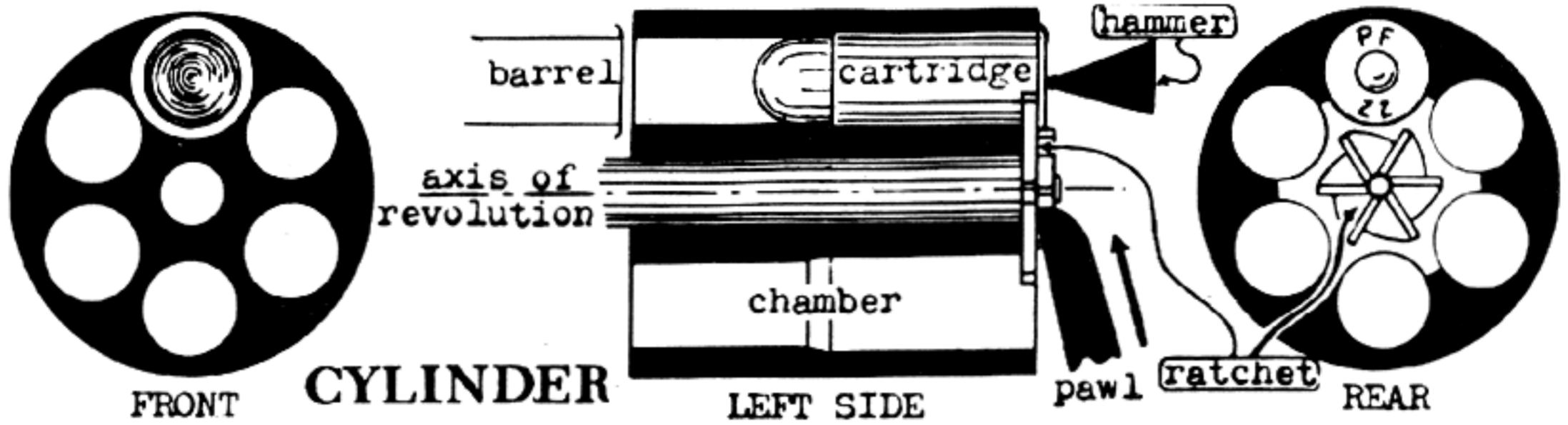



# NOTES ON OPERATING PRINCIPLES AND HOLSTERS

## THE SUB-MACHINE GUN

### TYPES OF COCKING

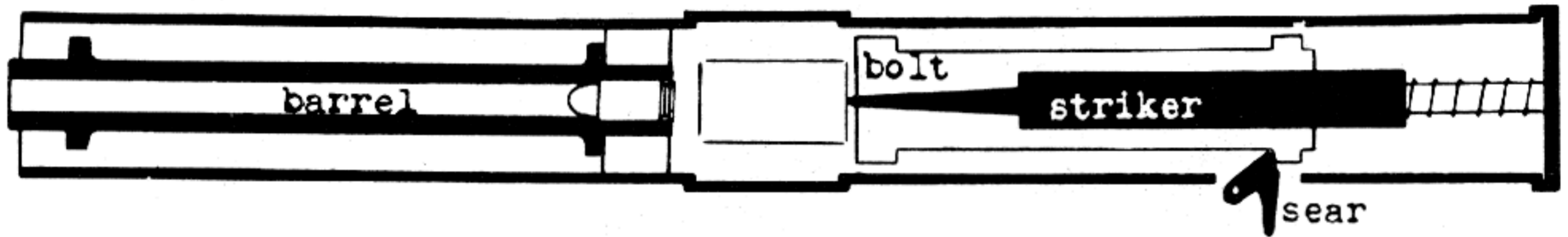

Open Breech: Example, Bergmann Machine Pistol

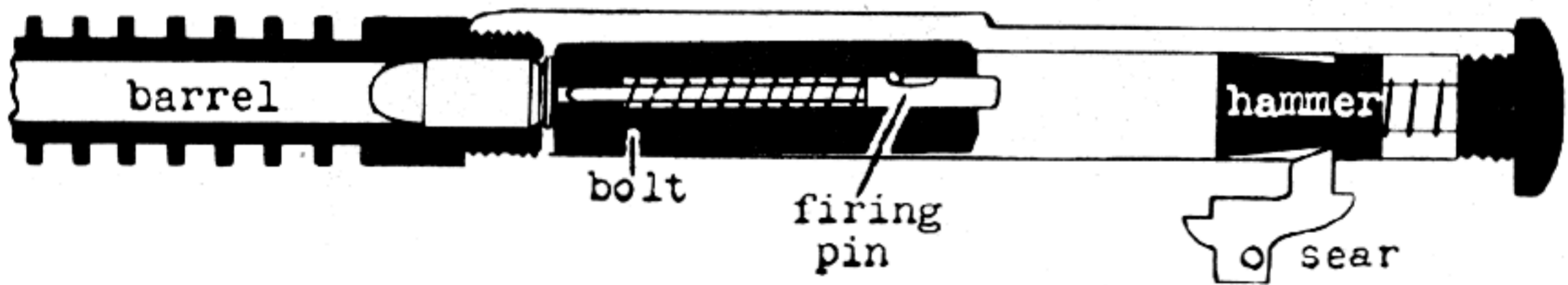

Closed Breech: Example, Reising Submachine Gun



# NOTES ON OPERATING PRINCIPLES AND HOLSTERS

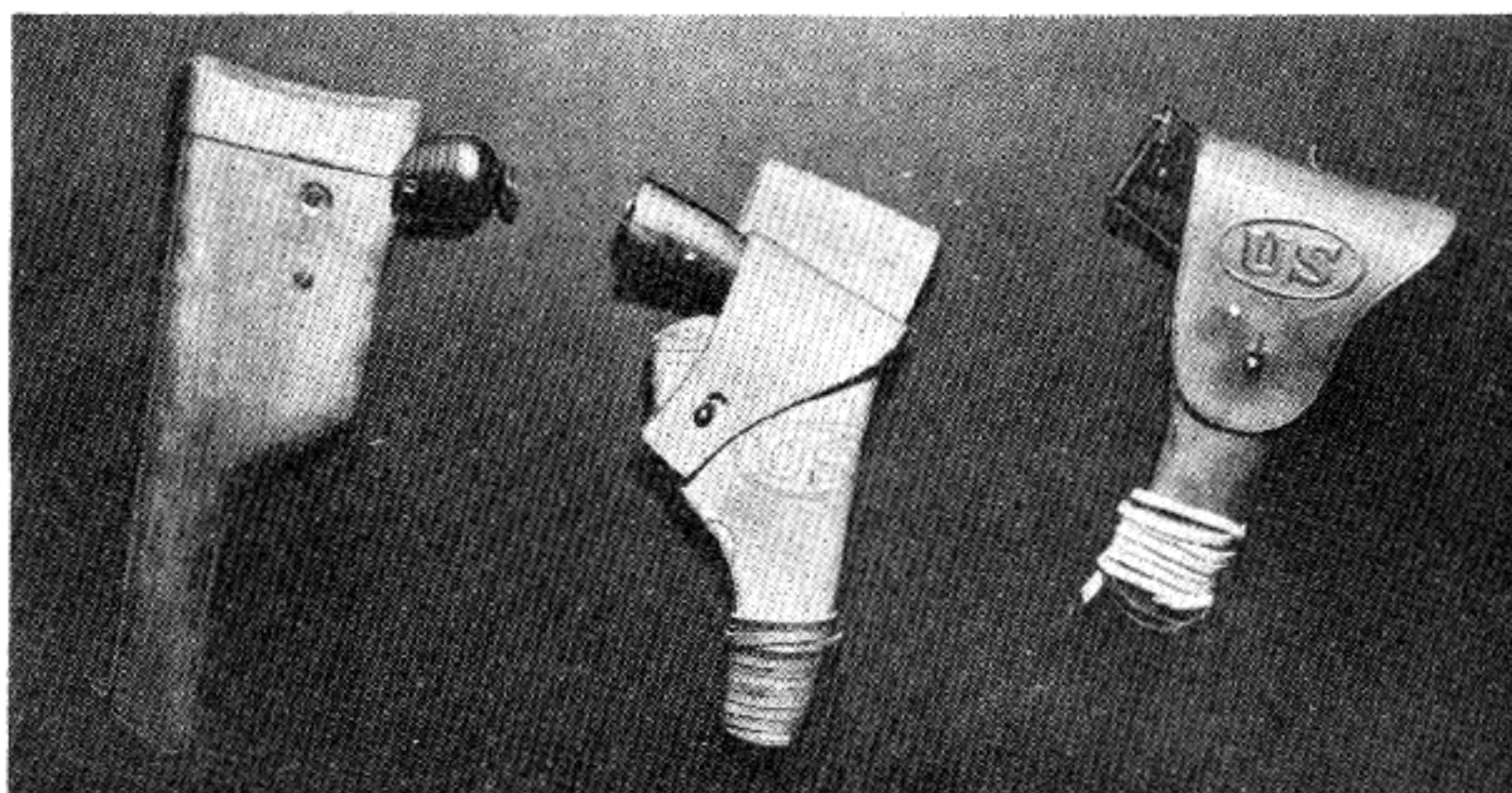

## HOLSTER TYPES

Left: German Mauser Automatic or Machine Pistol 1932 M  
Middle: U. S. Revolver Caliber .45  
Right: U. S. Automatic Caliber .45

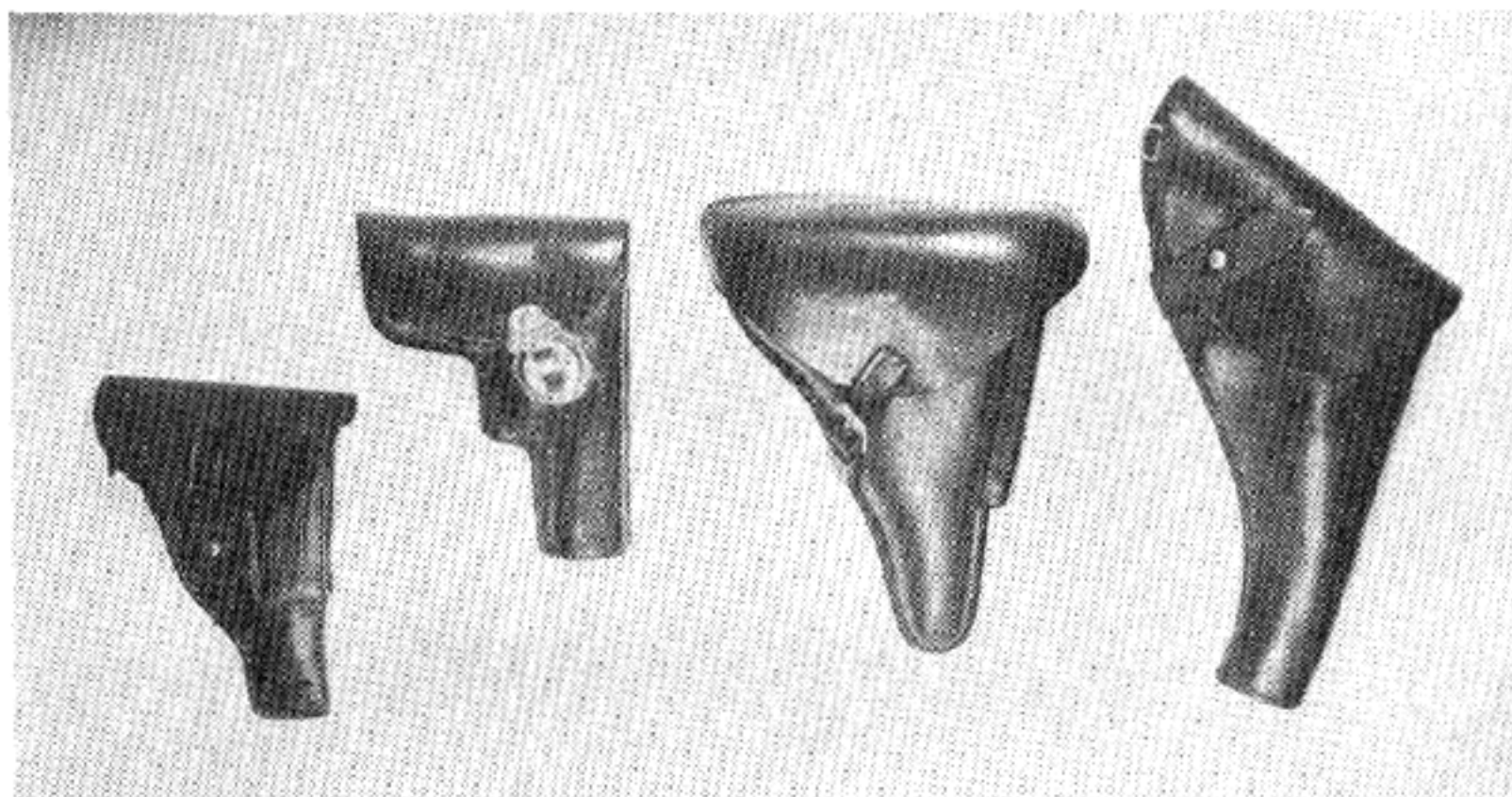

## TYPICAL CLOSED HOLSTERS

Left: German Staff Officer's, for small Mauser, etc.  
Center left: Hungarian and Balkan, for Frommer, etc.  
Center right: Luger type  
Right: British revolver

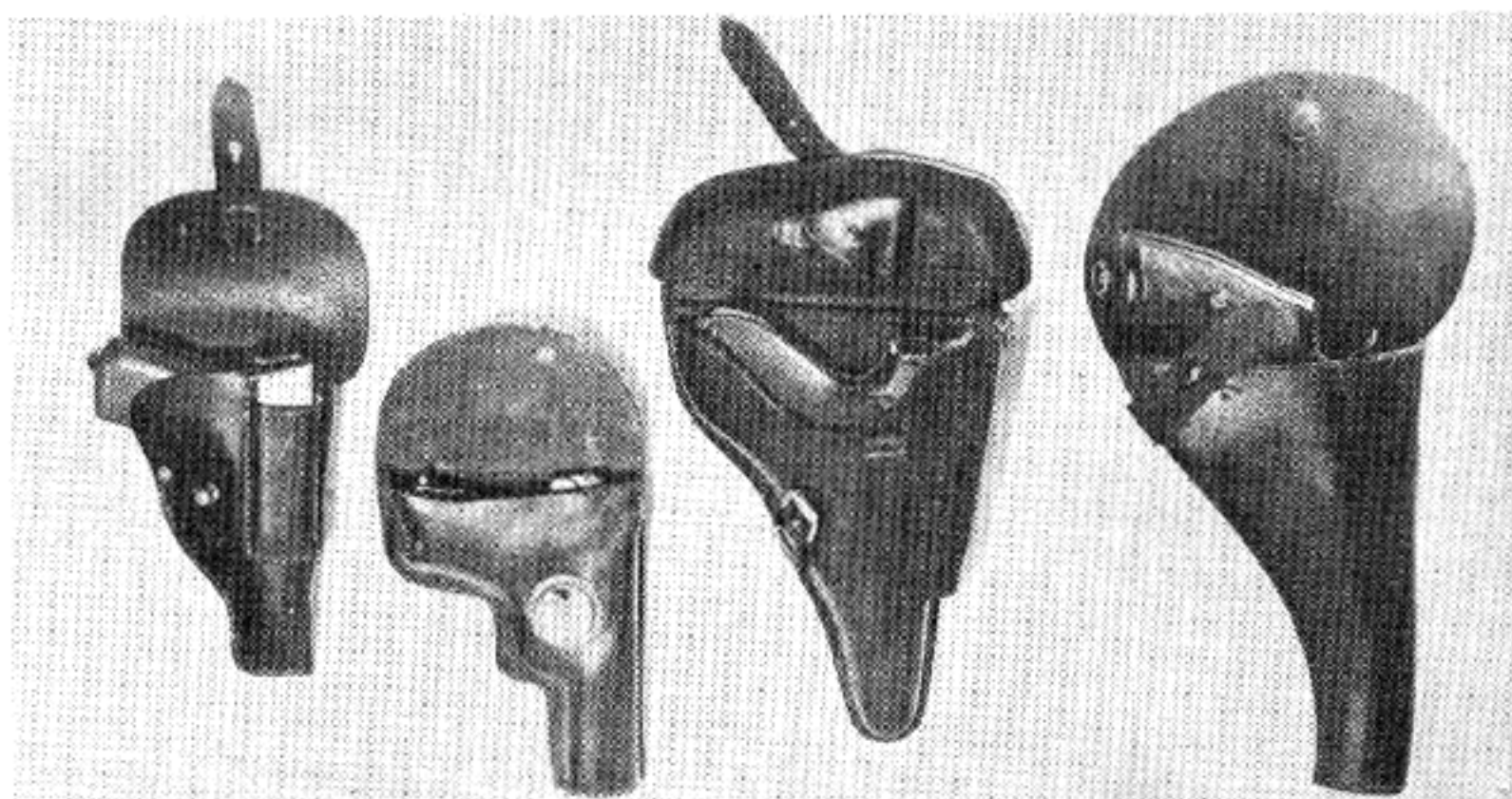

## TYPICAL OPEN HOLSTERS

Note that the German types (left and center right) all carry a spare magazine in the holster. Jap and Italian holsters follow this pattern.